

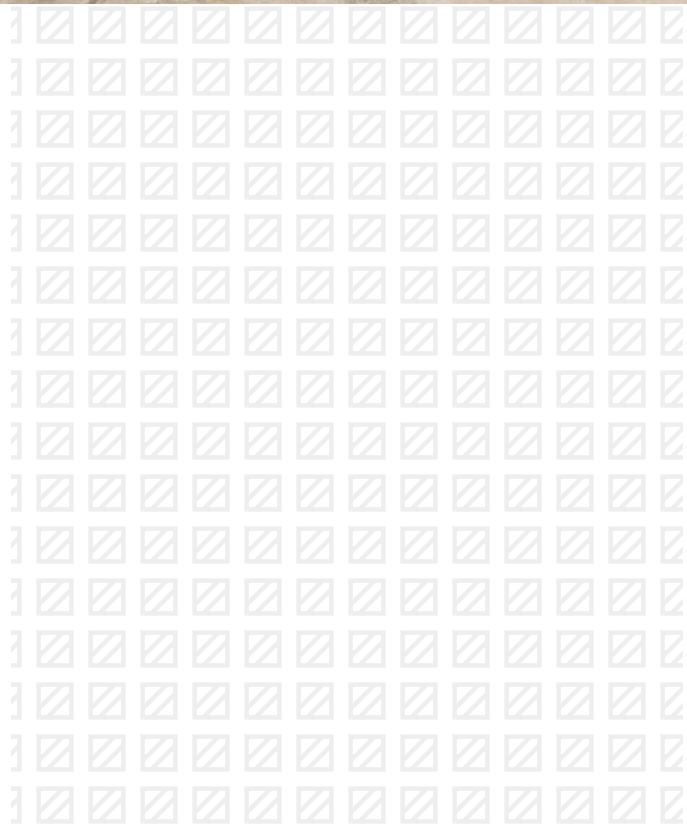

STONE & CLASSIC
COLLECTION



ILCOTTOTAGINA



**Tagina**
ITALY'S BEST SURFACES

ILCOTTOTAGINA

Una collezione forte ed intrigante, in stile grunge, ispirata da "cotti" oramai centenari tipici della zona del centro Italia. **ILCOTTOTAGINA** è un progetto caratterizzato da un'accurata attività di ricerca dove ogni faccia è stata creata su misura, con tonalità calibrate per realizzare una leggera stonizzazione e per dar luogo ad ambienti non solo classici ma anche moderni con uno stile inusuale. Quattro toni caldi, accoglienti e delicati, che si adattano a qualsiasi spazio indoor e outdoor, in stile classico e moderno grazie anche al grande formato 90x90 disponibile fino al 30 mm di spessore.

An intriguing collection with high visual impact and a grunge mood, inspired by the hundred-year-old terracotta tiles traditionally found in Central Italy. Created from thorough research activity, the **ILCOTTOTAGINA** collection features bespoke surfaces with careful calibrated shades and varying tonal intensities, designed for both classic and contemporary settings with an eclectic feel.

Four warm, welcoming, subtle colour options, suitable for any indoor and outdoor space, are ideal for classic designs, with a contemporary twist added through the large 90x90 slab available in thicknesses of up to 30 mm thick.

Une collection forte et intrigante, dans le style grunge, inspirée des « cottes » désormais centenaires, typiques du centre de l'Italie. **ILCOTTOTAGINA** est un projet caractérisé par une recherche minutieuse où chaque face a été réalisé sur mesure, avec des nuances calibrées pour créer une légère stonisation et donner naissance à des espaces classiques et modernes avec un style inhabituel. Quatre tons chauds, douillets et délicats qui s'adaptent à tout espace intérieur ou extérieur, dans un style classique ou moderne, grâce aussi au grand format 90x90 disponible jusqu'à 30 mm d'épaisseur.

Eine starke und faszinierende Kollektion im Grunge-Stil, die von den nunmehr hundert Jahre alten, für Mittelitalien typischen „Tonfliesen“ inspiriert wird. **ILCOTTOTAGINA** ist ein Projekt, das durch eine sorgfältige Forschungstätigkeit gekennzeichnet ist bei der jede Seite nach Maß erstellt wurde. Die Farbtöne sind so kalibriert, dass sie eine leichte Schattierung entstehen lassen und Umgebungen schaffen, die nicht nur klassisch, sondern auch modern sind und einen ungewöhnlichen Stil aufweisen.

Vier warme, einladende und zarte Töne, die sich auch dank des großen Formats von 90x90, das bis zu einer Stärke von 30 mm erhältlich ist, sowohl im klassischen als auch im modernen Stil jedem Innen- und Außenbereich anpassen.

100% Made in Italy





GREY 90x90 Nat. Ret. - GREY 90x90 Déco Stencil Nat. Ret.



NATURAL 60x60 Nat. Ret.
NATURAL 30x60 Nat. Ret.
NATURAL 30x60 Déco Painted Nat. Ret.







RED 90x90 20 mm Nat. Ret. R11
RED 90x90 Déco Stencil 20 mm Nat. Ret. R11

FORMATI

Sizes / Formats / Formate

10 mm . 90x90 - 35 1/2"x35 1/2" / 60x60 - 24"x24" / 30x60 - 12"x24" / 31x31 - 12"x12"
 10 mm R11 . 90x90 - 35 1/2"x35 1/2"
 20 mm R11 . 90x90 - 35 1/2"x35 1/2" / 60x60 - 24"x24"
 30 mm R11 . 90x90 - 35 1/2"x35 1/2" / 60x60 - 24"x24"

COLORI

Colours / Couleurs / Farben



NATURAL



CLEAR



RED

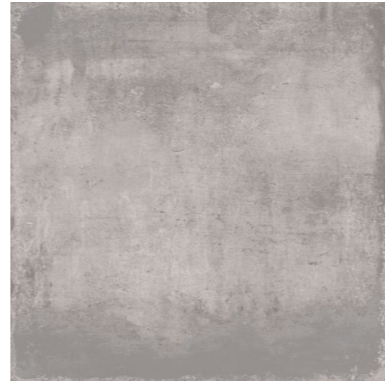

GREY

DECORI

Decors / Décors / Dekore



DECO PAINTED NATURAL



DECO PAINTED CLEAR



DECO PAINTED RED



DECO PAINTED GREY



DECO STENCIL NATURAL



DECO STENCIL CLEAR



DECO STENCIL RED



DECO STENCIL GREY

CONTINUITÀ PROGETTUALE INDOOR-OUTDOOR

Design continuity indoors and out / Continuité conceptuelle à l'intérieur et à l'extérieur / Entwurfskontinuität im innen- und Aussenbereich



INDOOR

Soluzioni contemporanee per l'interior design
 Contemporary solutions for interior design.
 Solutions contemporaines pour le design intérieur.
 Zeitgemäße Lösungen für das Interior Design.

SPESSORE THICKNESS 10mm



OUTDOOR

Versatilità e prestazioni per la progettazione in esterna
 Versatility and performance for outdoor design.
 Polyvalence et performance pour l'aménagement extérieur.
 Vielseitigkeit und Leistungen für Outdoor-Design.

SPESSORE THICKNESS 20mm 30mm

SISTEMI DI POSA

Laying systems / Systemes de pose / Verlegearten

Posa su erba

Laying on grass
 Pose sur l'herbe
 Verlegung auf Wiese

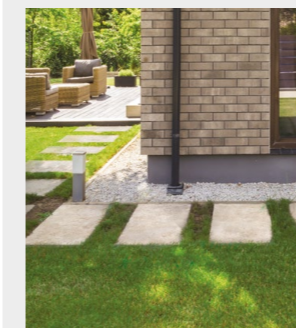

Posa su sabbia

Laying on sand
 Pose sur sable
 Verlegung auf Sand



Posa sopraelevata

Raised laying
 Pose surélevée
 Verlegung auf Stelzlägern



Posa su ghiaia

Laying on gravel
 Pose sur gravier
 Verlegung auf Kies



Posa tradizionale

Standard laying
 Pose traditionnelle
 Herkömmliche Verlegung

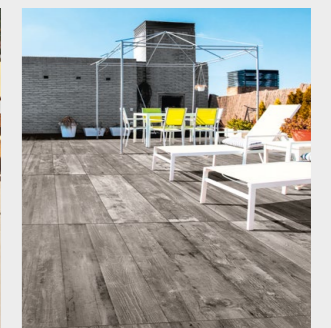

Spessore . Thickness . Epaisseur . Stärke - 10 mm

Gres porcellanato colorato in massa. Full-body coloured porcelain stoneware. Grès cérame coloré dans la masse. In der Masse gefärbtes Feinsteinzeug.

INDOOR

TABELLA RIEPILOGATIVA
Summary table
Tableau récapitulatif
Zusammenfassenden Tabelle

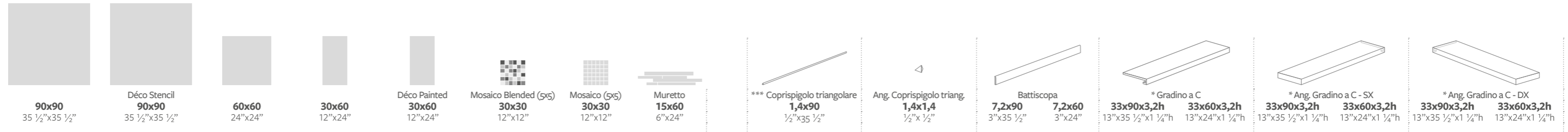

SPESSORE - THICKNESS - EPAISSEUR - STÄRKE		10 mm	10 mm	10 mm	10 mm	10 mm	10 mm	10 mm	10 mm	10 mm	10 mm	10 mm	10 mm	10 mm	10 mm	10 mm	10 mm	10 mm		
	NATURAL <input type="checkbox"/> Nat. Ret.	116041	116037	116095	116158	116162	116166	116168	116220		116230	116235	116250	116240	116278	116260	116290	116272	116284	116266
	CLEAR <input type="checkbox"/> Nat. Ret.	116044	116039	116097	116160	116164	116166	116170	116221		116231	116236	116251	116241	116279	116261	116291	116273	116285	116267
	RED <input type="checkbox"/> Nat. Ret.	116040	116036	116094	116157	116161	116166	116167	116222		116232	116237	116252	116242	116280	116262	116292	116274	116286	116268
	GREY <input type="checkbox"/> Nat. Ret.	116042	116038	116096	116159	116163	116166	116169	116223		116233	116238	116253	116243	116281	116263	116293	116275	116287	116269
		Pallet	Pallet	Pallet	Pallet	Pallet	Pallet	Pallet	Pallet				Pallet	Pallet	Pallet	Pallet	Pallet	Pallet	Pallet	Pallet
		94x120	94x120	80x120	80x120	80x120	80x120	80x120	80x120				80x120	80x120	80x120	80x120	80x120	80x120	80x120	80x120
	N°																			
	m²																			
	Kg																			
	x	2	2	3	7	7	11	11	3		6		8	14	2	4	1	2	1	2
	m² x	1,62	1,62	1,08	1,26	1,26	0,99	0,99	0,27											
	Kg x	35	35	24,4	30,3	30,3	20	20	6		2		12	14,5	16,5	22	8,25	11	8,25	11
	m² x	20	20	40	40	40														
	** Kg x	32,4	32,40	43,2	50,4	50,4														
	** Kg x	720	720	996	1232	1232														
	h x	70	70	76	76	76														
	Imballo (tara) - Packaging (tare)	(20)	(20)	(20)	(20)	(20)	(20)	(20)	(20)				(20)	(20)	(20)	(20)	(20)	(20)	(20)	(20)

I pesi riportati in tabella sono indicativi e potrebbero essere soggetti a leggere variazioni.
The weights stated in the chart may undergo slight changes for production reasons.
Les poids indiqués dans le tableau peuvent subir de légères variations pour des raisons de production.
Die in der Tabelle angegebenen Gewichte können aus Produktionsgründen geringfügigen Abweichungen unterliegen.

Non si garantisce l'abbinabilità tra fondi di spessori diversi e tra fondo e pezzo speciale.
It is not guaranteed that background tiles with different thicknesses can be used together, nor is it guaranteed for background tiles and trims.
Nous ne garantissons pas la possibilité de combiner des carrelages de sol de différentes épaisseurs et un carrelage de sol avec une pièce spéciale.
Die Kombinierbarkeit von Fliesen unterschiedlicher Stärke sowie zwischen Fliese und Formteil kann nicht garantiert werden.

* A disposizione solo su richiesta. Tempi di consegna 30 gg.
Available upon request only. Delivery terms: 30 days.
Disponible seulement sur requête. Délais de livraison: 30 jours.
Verfügbar auf Anfrage. Lieferzeit: 30 Tage.

** Il peso è comprensivo dell'imballo.
The total weight includes the packaging.
Le poids comprend aussi l'emballage.
Das Gesamtgewicht enthält auch die Verpackung.

*** Vendita a scatola completa.
Full box sale.
Vente à la boîte complète.
Volle Kartons.

Naturale e rettificato.
Natural and rectified.
Naturél et rectifié.
Natur Oberfläche und kalibriert.

Spessore . Thickness . Epaisseur . Stärke - 10 mm R11 / 20 mm R11 / 30 mm R11

Gres porcellanato colorato in massa. Full-body coloured porcelain stoneware. Grès cérame coloré dans la masse. In der Masse gefärbtes Feinsteinzeug.

OUTDOOR

TABELLA RIEPILOGATIVA
Summary table
Tableau récapitulatif
Zusammenfassenden Tabelle



90x90
35 1/2"x35 1/2"



90x90
35 1/2"x35 1/2"

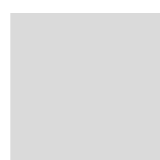

Déco Stencil
90x90
35 1/2"x35 1/2"



Déco Painted
90x90
35 1/2"x35 1/2"



60x60
24"x24"



Déco Stencil
60x60
24"x24"



Déco Painted
60x60
24"x24"



90x90
35 1/2"x35 1/2"



60x60
24"x24"

SPESSORE - THICKNESS - EPAISSEUR - STÄRKE		10 mm	20 mm	20 mm	20 mm	20 mm	20 mm	20 mm	20 mm	30 mm	30 mm
	NATURAL R11 <input type="checkbox"/> Nat. Ret.	116020	116046	116058	116062		116107	116111	116115	116050	116100
	CLEAR R11 <input type="checkbox"/> Nat. Ret.	116022	116048	116060	116064		116109	116113	116117	116052	116101
	RED R11 <input type="checkbox"/> Nat. Ret.	116024	116045	116057	116061		116106	116110	116114	-	-
	GREY R11 <input type="checkbox"/> Nat. Ret.	116026	116047	116059	116063		116108	116112	116116	116051	116099
		Pallet	Pallet	Pallet	Pallet		Pallet	Pallet	Pallet	Pallet	Pallet
		94x120	94x94	94x94	94x94		80x120	80x120	80x120	95x95	65x120
N°											
m²											
Kg											
		2	1	1	1		2	2	2	1	1
m² x		1,62	0,81	0,81	0,81		0,72	0,72	0,72	0,81	0,36
Kg x		35	37	37	37		30	30	30	55	25
		20	30	30	30		32	32	32	20	44
m² x		32,4	24,30	24,30	24,30		23,04	23,04	23,04	16,2	15,84
** Kg x		720	1130	1130	1130		980	980	980	1120	1116
h x		70	80	80	80		76	76	76	78	84
Imballo (tara) - Packaging (tare)		(25)	(20)	(20)	(20)		(20)	(20)	(20)	(20)	(16)

I pesi riportati in tabella sono indicativi e potrebbero essere soggetti a leggere variazioni.
The weights stated in the chart may undergo slight changes for production reasons.
Les poids indiqués dans le tableau peuvent subir de légères variations pour des raisons de production.
Die in der Tabelle angegebenen Gewichte können aus Produktionsgründen geringfügigen Abweichungen unterliegen.

Non si garantisce l'abbinabilità tra fondi di spessori diversi e tra fondo e pezzo speciale.
It is not guaranteed that background tiles with different thicknesses can be used together, nor is it guaranteed for background tiles and trims.
Nous ne garantissons pas la possibilité de combiner des carrelages de sol de différentes épaisseurs et un carrelage de sol avec une pièce spéciale.
Die Kombinierbarkeit von Fliesen unterschiedlicher Stärke sowie zwischen Fliese und Formteil kann nicht garantiert werden.

○ Nuova pallettizzazione disponibile ad esaurimento dello stock esistente.
New pallet configuration once current stock fully exhausted.
Nouvelle palettisation disponible jusqu'à épuisement du stock existant.
Neue Palettierung verfügbar solange der Vorrat reicht.

Naturale e rettificato.
Natural and rectified.
Naturel et rectifié.
Natur Oberfläche und kalibriert.



** Il peso è comprensivo dell'imballo.
The total weight includes the packaging.
Le poids comprend aussi l'emballage.
Das Gesamtgewicht enthält auch die Verpackung.

Spessore . Thickness . Epaisseur . Stärke - 20 mm R11

Gres porcellanato colorato in massa. Full-body coloured porcelain stoneware. Grès cérame coloré dans la masse. In der Masse gefärbtes Feinsteinzeug.



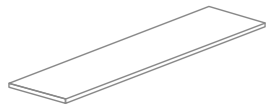

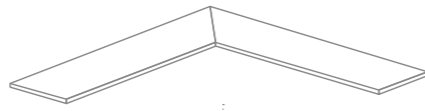
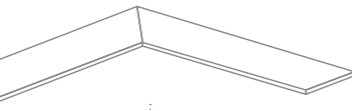
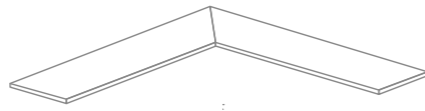
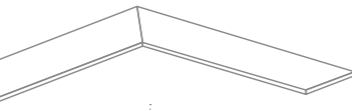

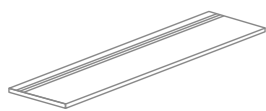
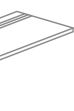
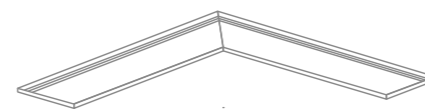
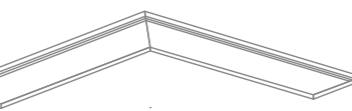
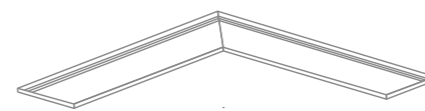
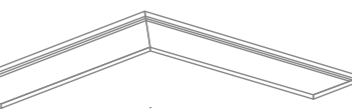

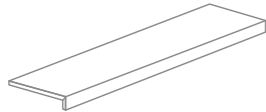
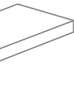
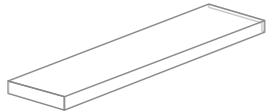
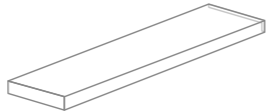
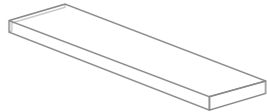
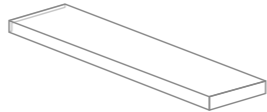
Pezzi speciali per esterno

Special pieces for outdoor - Pièces spéciales pour extérieur - Formteile für Aussenbereich

					
* Gradone □ Nat. Ret.		* Ang. Gradone - SX □ Nat. Ret.		* Ang. Gradone - DX □ Nat. Ret.	
30x90 12"x35 1/2"	30x60 12"x24"	30x90 12"x35 1/2"	30x60 12"x24"	30x90 12"x35 1/2"	30x60 12"x24"
SPESSORE - THICKNESS - EPAISSEUR - STÄRKE		20 mm		20 mm	

					
* Gradone grip □ Nat. Ret.		* Ang. Gradone grip - SX □ Nat. Ret.		* Ang. Gradone grip - DX □ Nat. Ret.	
30x90 12"x35 1/2"	30x60 12"x24"	30x90 12"x35 1/2"	30x60 12"x24"	30x90 12"x35 1/2"	30x60 12"x24"
SPESSORE - THICKNESS - EPAISSEUR - STÄRKE		20 mm		20 mm	

					
* Elemento a L □ Nat. Ret.		* Elemento a L □ Nat. Ret.		* Elemento a L □ Nat. Ret.	
33x90x4h 13"x35 1/2"x1 1/2"h	33x60x4h 13"x24"x1 1/2"h	33x90x4h 13"x35 1/2"x1 1/2"h	33x60x4h 13"x24"x1 1/2"h	33x90x4h 13"x35 1/2"x1 1/2"h	33x60x4h 13"x24"x1 1/2"h
SPESSORE - THICKNESS - EPAISSEUR - STÄRKE		20 mm		20 mm	

							
*** piedino regolabile 25-30	*** piedino regolabile 30-37	*** piedino regolabile 37-50	*** piedino regolabile 50-75	*** piedino regolabile 75-125	*** piedino regolabile 125-225	*** prolunga piedini h 100 mm	chiave di regolazione
600101	600102	600103	600104	600105	600106	600107	600108
	20	20	20	20	20	20	1

* A disposizione solo su richiesta. Tempi di consegna 30 gg.
Available upon request only. Delivery terms: 30 days.
Disponible seulement sur requête. Délais de livraison: 30 jours.
Verfügbar auf Anfrage. Lieferzeit: 30 Tage.

*** Vendita a scatola completa.
Full box sale.
Vente à la boîte complète.
Volle Kartons.



□ Naturale e rettificato.
Natural and rectified.
Naturel et rectifié.
Natur Oberfläche und kalibriert.



┃ Costa retta.
Straight edge.
Bord droit.
Gerade Kante.



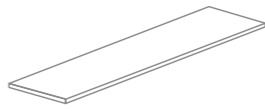

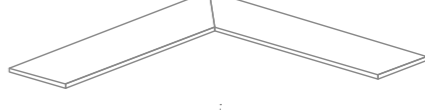
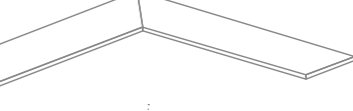
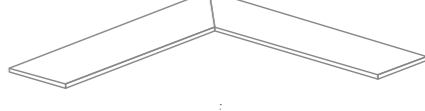
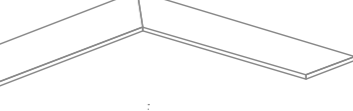
┃ Costa toro.
Bullnose edge.
Bord boudin.
Abgerundete Kante.

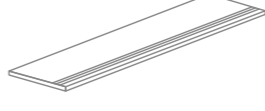
Pezzi speciali per piscina

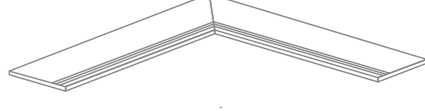
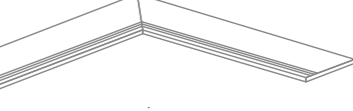
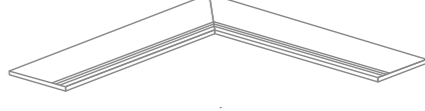
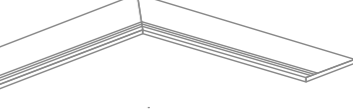
Special pieces for swimming pool - Pièces spéciales pour piscine - Formteile für Schwimmbad

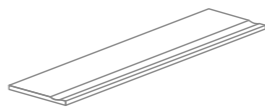
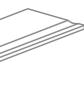
					
* Gradone bordo piscina □ Nat. Ret.		* Ang. Gradone bordo piscina - SX □ Nat. Ret.		* Ang. Gradone bordo piscina - DX □ Nat. Ret.	
30x90 12"x35 1/2"	30x60 12"x24"	30x90 12"x35 1/2"	30x60 12"x24"	30x90 12"x35 1/2"	30x60 12"x24"
SPESSORE - THICKNESS - EPAISSEUR - STÄRKE		20 mm		20 mm	

					
* Gradone grip □ Nat. Ret.		* Ang. Gradone grip - SX □ Nat. Ret.		* Ang. Gradone grip - DX □ Nat. Ret.	
30x90 12"x35 1/2"	30x60 12"x24"	30x90 12"x35 1/2"	30x60 12"x24"	30x90 12"x35 1/2"	30x60 12"x24"
SPESSORE - THICKNESS - EPAISSEUR - STÄRKE		20 mm		20 mm	

					
* Gradone svasato bordo piscina □ Nat. Ret.		* Ang. Gradone svasato bordo piscina - SX □ Nat. Ret.		* Ang. Gradone svasato bordo piscina - DX □ Nat. Ret.	
30x90 12"x35 1/2"	30x60 12"x24"	30x90 12"x35 1/2"	30x60 12"x24"	30x90 12"x35 1/2"	30x60 12"x24"
SPESSORE - THICKNESS - EPAISSEUR - STÄRKE		20 mm		20 mm	

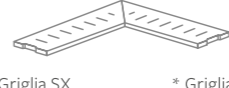
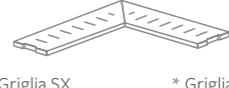
		
* Griglia □ Nat. Ret.	* Griglia SX □ Nat. Ret.	* Griglia DX □ Nat. Ret.
20x60 8"x24"	20x60 8"x24"	20x60 8"x24"
SPESSORE - THICKNESS - EPAISSEUR - STÄRKE		
20 mm	20 mm	20 mm

Per maggiori informazioni su imballi e codici articolo potete consultare il nostro BOOK (anche da sito internet, nell'area "download").
For more information on packaging and item codes, please refer to our BOOK (also available for download on our website, in the "download" area).
Pour plus d'informations sur les emballages et les codes articles, vous pouvez consulter notre BOOK (également depuis le site, dans la zone "téléchargement").
Weitere Informationen zu Verpackungen und Artikelcodes finden Sie in unserem BOOK (auch auf der Website, im Bereich "Download").

PEZZI SPECIALI PER ESTERNO

Special pieces for outdoor
Pièces spéciales pour extérieur
Formteile für Aussenbereich

Elemento a L



Gradone grip

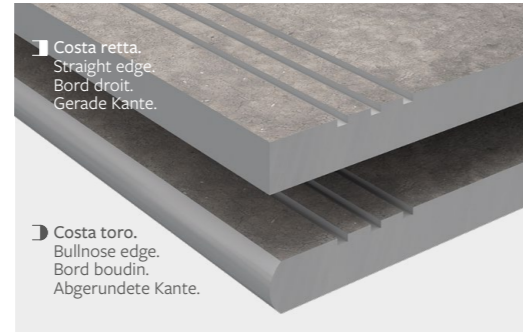

Gradone

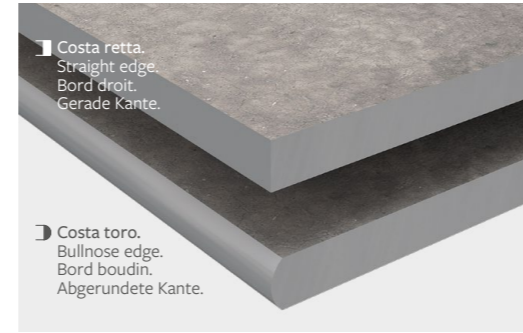

PEZZI SPECIALI PER PISCINA

Special pieces for swimming pool
Pièces spéciales pour piscine
Formteile für Schwimmbad

Gradone svasato bordo piscina

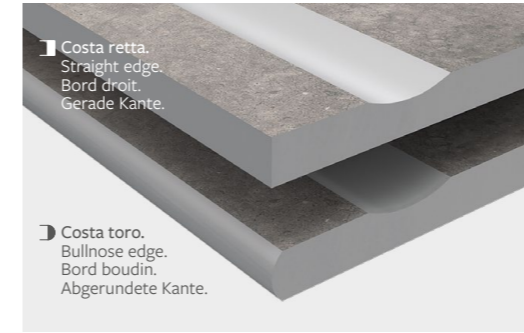

Gradone grip bordo piscina

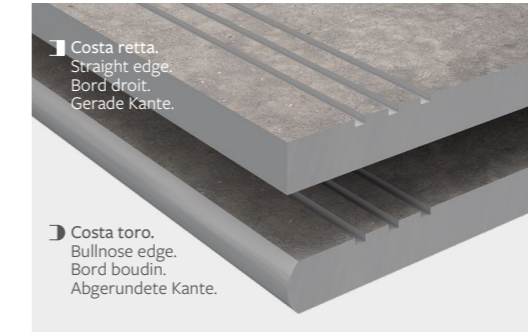

Gradone bordo piscina

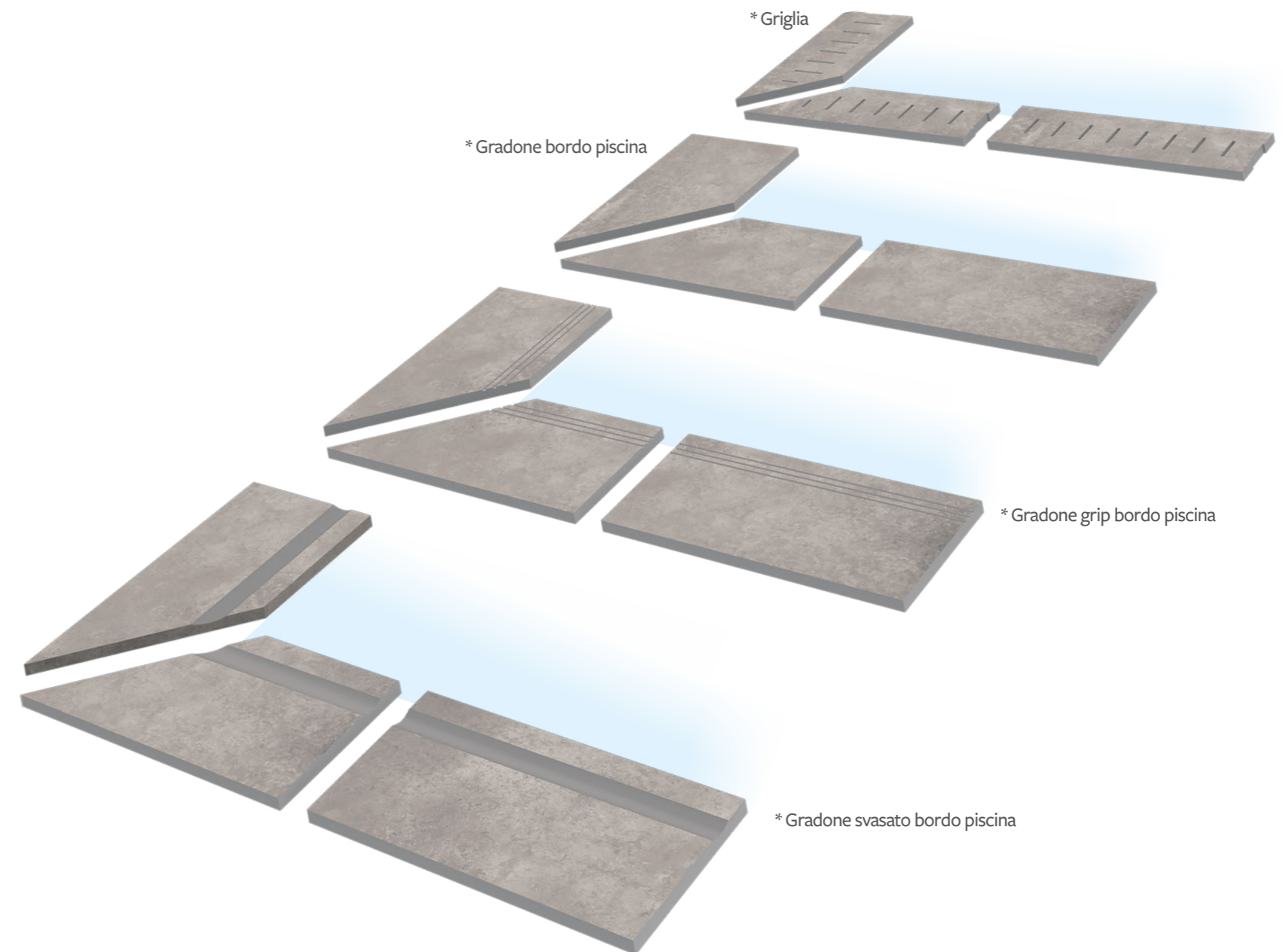
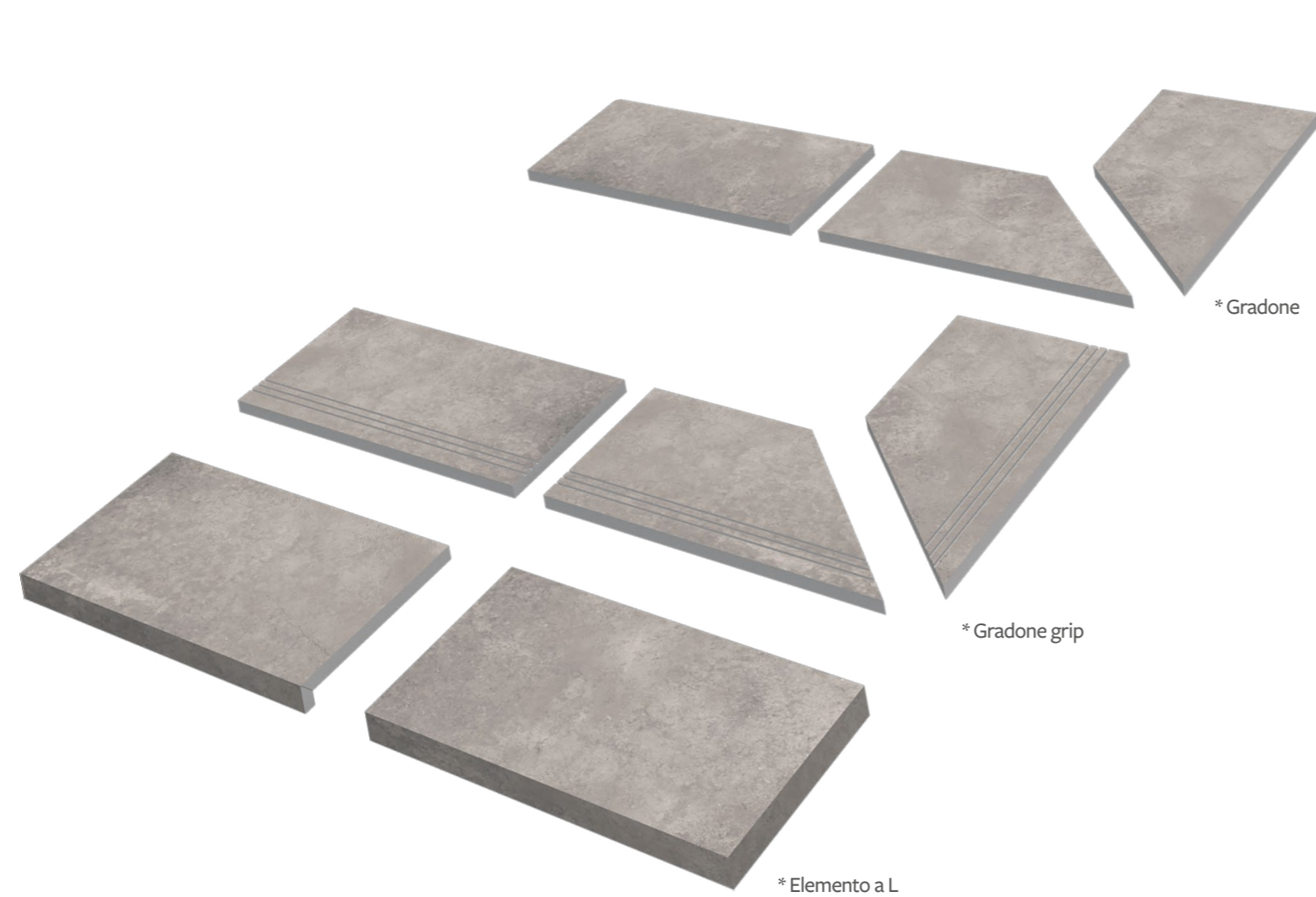
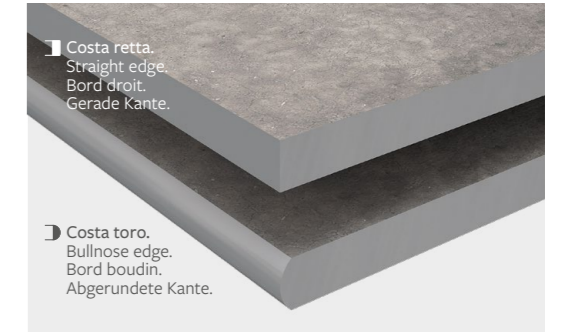

Per le condizioni generali di vendita e le caratteristiche tecniche consultare www.tagina.it
General terms and Sales conditions and Technical features are available on our website www.tagina.it
Les Conditions général de vente et les Caractéristiques techniques sont disponibles sur le site web www.tagina.it
Allgemeine Verkaufsbedingungen und technische Eigenschaften sind auf unsere Website verfügbar: www.tagina.it

* I tempi di consegna di tutti i pezzi speciali mostrati in queste pagine sono di 30 giorni dalla data dell'ordine.
Delivery time for all the special pieces shown on these pages are generally 30 days from order date.
La livraison de toutes les pièces spéciales présentés dans les pages du catalogue sont disponible 30 jours à compter de la date de commande.
Der Liefertermin fuer die Spezialteile, die in dieser Seite aufgeführt sind, beläuft sich auf 30 Tage nach Auftragseingang.

Tagina S.p.A. si riserva di modificare, senza alcun preavviso, il packaging dei prodotti, le grafiche, i colori e i decori riportati nelle immagini che sono pertanto da ritenersi indicative.
Tagina S.p.A. reserves the right to change the product packaging, the patterns, colours and decorations shown in the pictures without any prior notice. These aspects, therefore should be considered for illustrative purposes only.
Tagina S.p.A. se réserve le droit de modifier, sans préavis, l'emballage des produits, les graphismes, les couleurs et les décors représentés dans les images, fournies à titre indicatif.
Die Tagina S.p.A. behält sich vor, die Verpackung der Produkte, die in den Abbildungen gezeigten Grafiken, Farben und Dekors sowie ohne vorherige Ankündigung zu ändern.

Pezzi speciali: massima cura in ogni dettaglio

Special pieces: the utmost care in every detail.
Pièces spéciales : le soin maximal dans le moindre détail.
Formteile: maximale Sorgfalt in jedem Detail.

IL FASCINO TRADIZIONALE DEL GRADINO A "C"

The traditional appeal of the "C" step.
Le charme traditionnel de l'étape « C »
Der traditionelle Charme der „C“-Stufe.

Tagina pone attenzione a tutte le componenti architettoniche degli spazi da abitare. Ai gradini sono dedicati pezzi speciali appositamente progettati per ottenere il massimo risultato estetico. La gamma comprende un elemento "gradino a C" al quale si possono affiancare gli elementi che completano gli angoli sinistro e

Tagina takes great care over all the architectural elements of the living spaces. Special pieces are used for the stairs, specially designed to obtain the maximum aesthetic result. The range includes a "C-step" element which can be combined with the elements that complete the left and right corners.

Tagina prête attention à toutes les composantes architecturales des espaces de vie. Les étapes sont dédiées à des pièces spéciales spécialement conçues pour obtenir un résultat esthétique maximal. La gamme comprend un élément « marche en C » auquel vous pouvez assortir les autres éléments qui complètent les angles gauche et droit.

Tagina achtet auf alle architektonischen Komponenten der Wohnräume. Den Stufen sind Spezialteile gewidmet, um ein optimales ästhetisches Ergebnis zu erzielen. Das Sortiment umfasst ein „C-Stufen-Element“, das durch Elemente zur Vervollständigung der linken und rechten Ecke ergänzt werden kann.

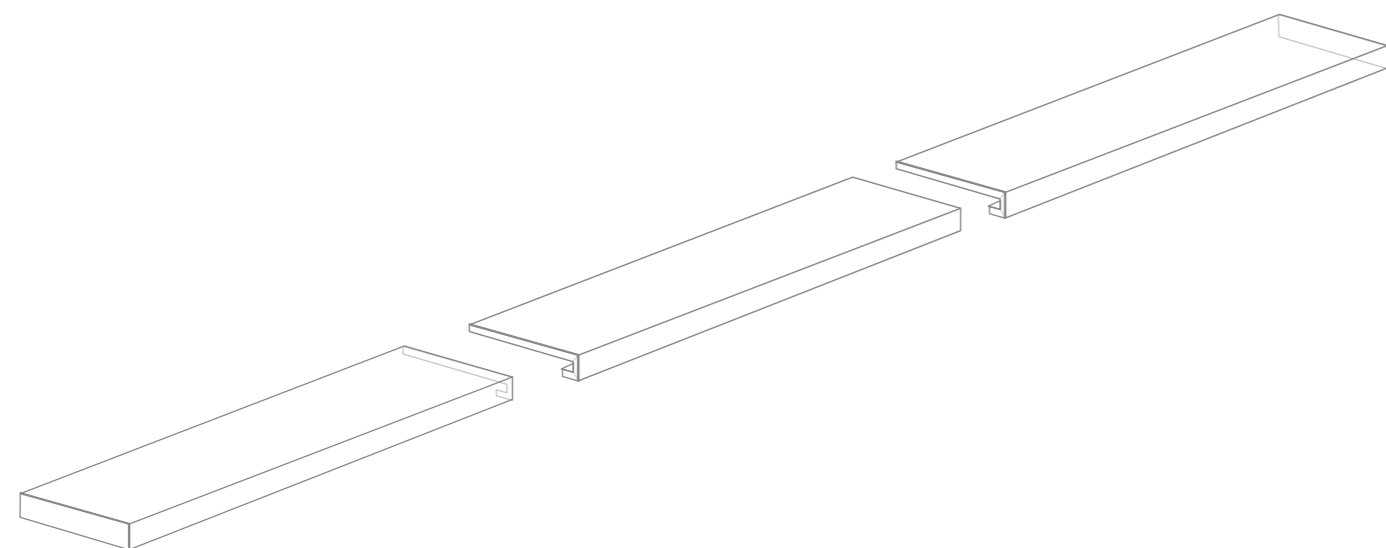

IL "COPRISPIGOLO TRIANGOLARE"

The "triangular edge cover".
Le « cache-arête triangulaire »
„Dreieckiger Kantenschutz“

La gamma della collezione "Ilcottotagina" include l'elemento "Coprispigolo triangolare" e "Angolo Coprispigolo triangolare". Consente di risolvere con eleganza e semplicità problematiche legate alla congiunzione delle lastre in presenza di spigoli e angoli. È possibile adottare questa soluzione sia a rivestimento che a pavimento ad esempio per realizzare gradini o per comporre volumi geometrici.

The range of the "Ilcottotagina" collection includes the "Triangular edge cover and Triangular corner edge cover" element. It allows problems encountered to be solved elegantly and simply when joining slabs where there are edges and corners. It is possible to adopt this solution both for cladding and flooring, e.g. to create steps or compose geometric volumes.

La gamme de la collection « Ilcottotagina » comprend l'élément « Cache-arête Triangulaire et Angle Cache-arête Triangulaire ». Il permet de résoudre avec élégance et simplicité les problèmes liés à l'assemblage des dalles en présence de bords et de coins. Il est possible d'adopter cette solution aussi bien pour le revêtement que pour le dallage, par exemple pour créer des marches ou composer des volumes géométriques.

Das Sortiment der Kollektion „Ilcottotagina“ umfasst das Element „Dreieckige Eckabdeckung und Winkel Dreieckige Eckabdeckung“. Es ermöglicht, mit Eleganz und Einfachheit alle Probleme zu lösen, die mit dem Zusammenfügen der Platten bei Vorhandensein von Kanten und Ecken zusammenhängen. Diese Lösung kann sowohl für Verkleidungen als auch für Böden verwendet werden, beispielsweise um Stufen oder geometrische Volumen zu schaffen.

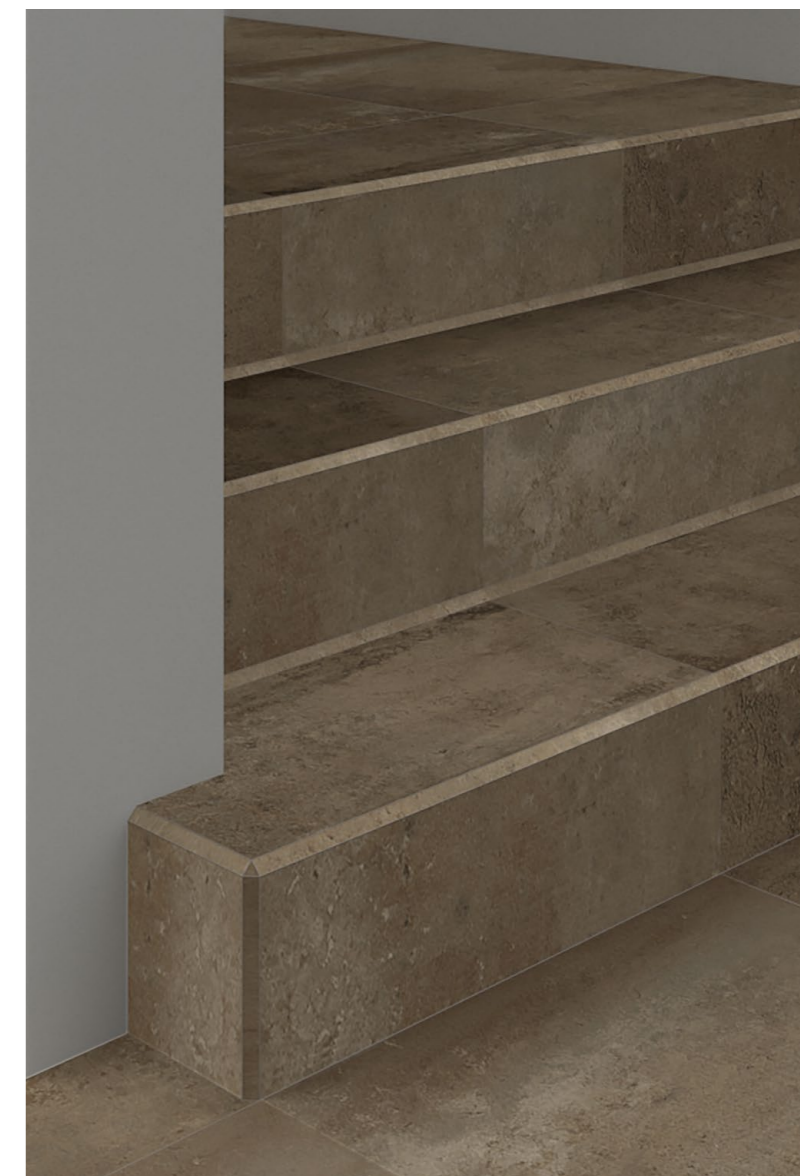



Tagina S.p.A.
Via Emilia Ponente, 925
48014 Castel Bolognese (RA) - Italy
Tel. +39 0545 197 7303

tagina.it -  DAFIN GROUP

