

AXOR

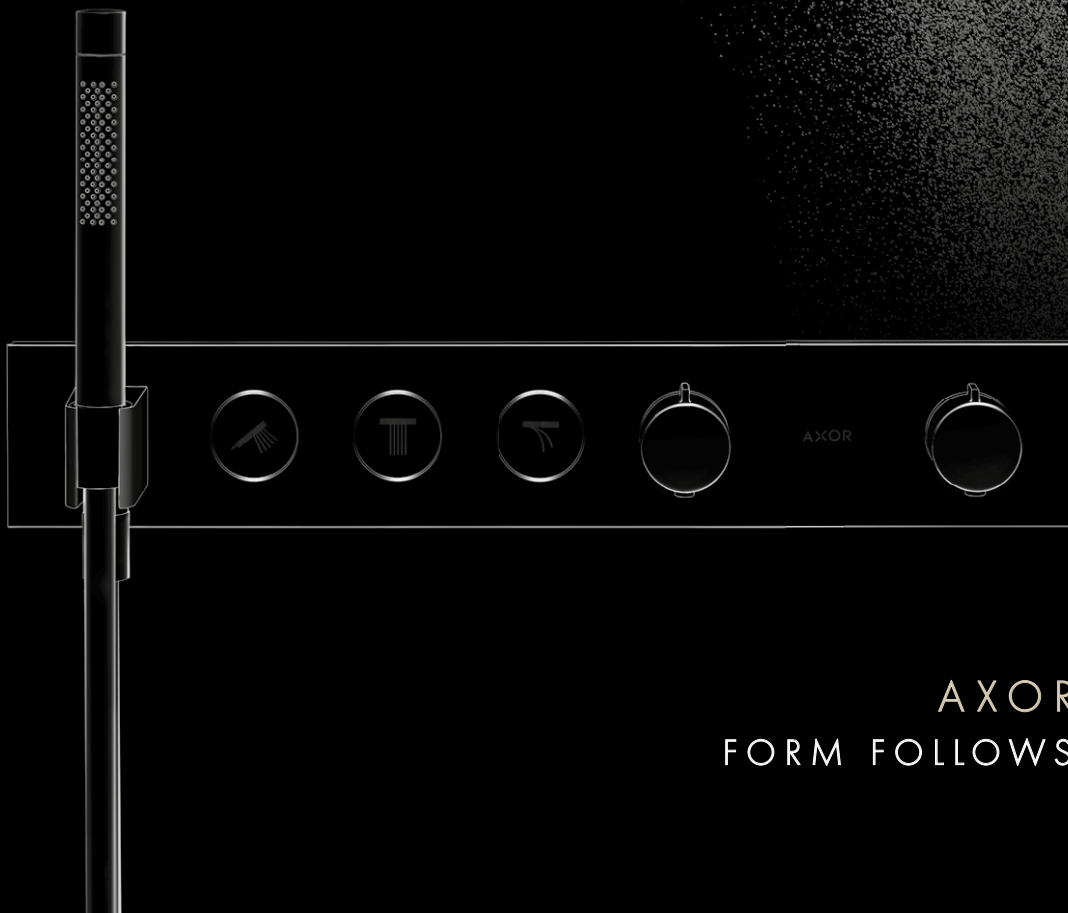

AXOR SHOWERS  
FORM FOLLOWS PERFECTION









## FORM FOLLOWS PERFECTION

05

Three words that change how we think, create and produce: Form Follows Function. It is a principle that equates to a revolution. No form and no function can be considered in isolation. What distinguishes AXOR is greater. Not ending the developmental process until there's nothing left to be added or removed. Until the product is more than the combination of form and function. With this aspiration in mind, we develop, design and produce taps, showers and accessories. For bathrooms and kitchens. With the world's best designers. Full of pioneering innovations without compromises. In perfection.

[axor-design.com](http://axor-design.com)

AXOR SHOWERS

THE ULTIMATE  
FOR THE SHOWER.  
IN PERFECTION.





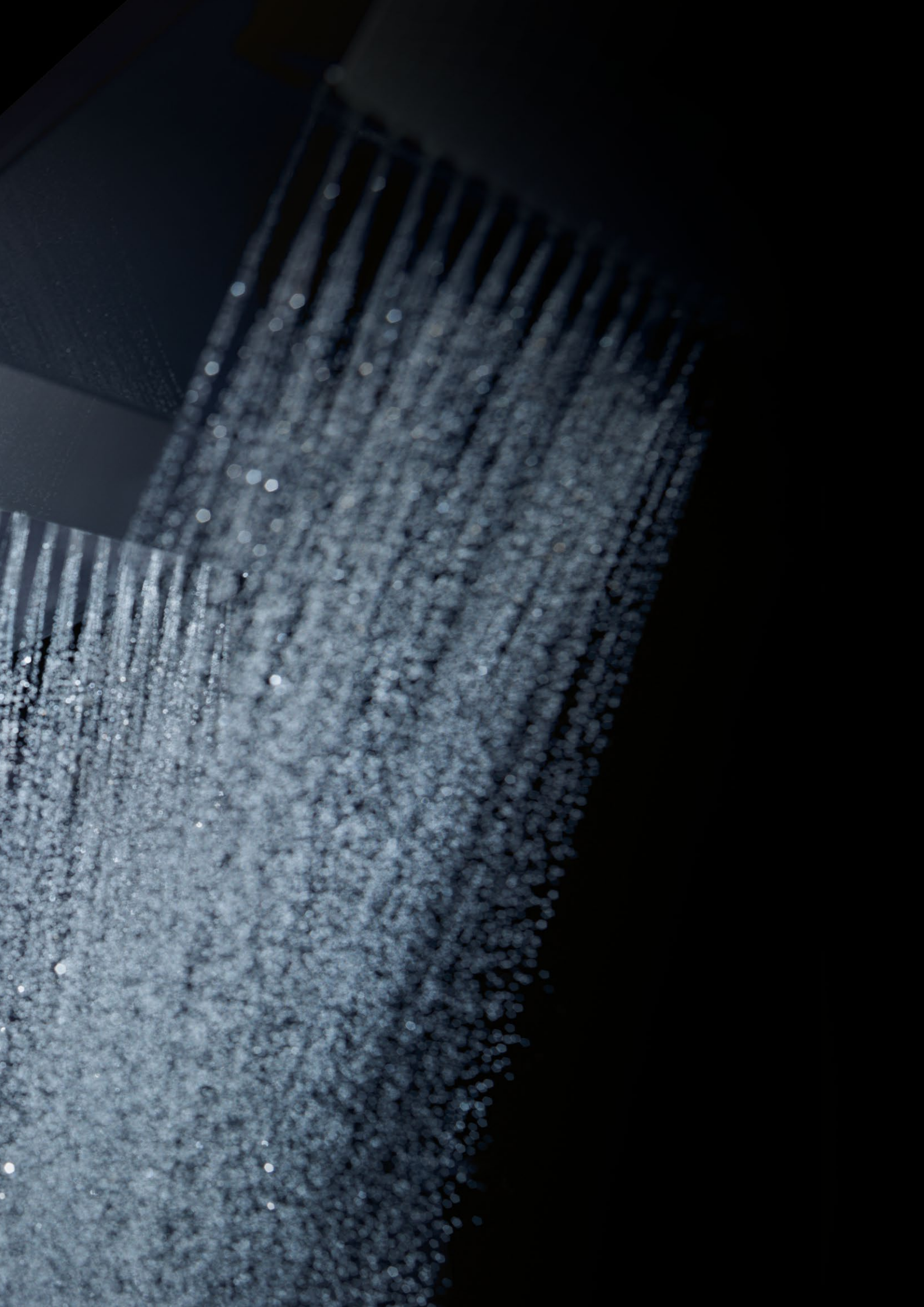

Avantgarde in design. An immaculate sense of space.  
A captivating water experience. AXOR products are the ultimate in shower design. An homage to the precious element that is water. A perfect design object for the body. For the soul. For the room. Making the shower a place to be savoured. Luxury for the body.

Every drop is perfectly and precisely shaped. Full of revitalising energy. Gentle, enveloping and sensual. Perfect overhead showers and shower systems give the technology a perfect form. Particularly the AXOR ShowerHeaven 1200/300 4jet, which features a brand-new element in water design – the gentle PowderRain.

AXOR showers include overhead showers, hand showers, side showers and shower systems. In a wide variety of shapes and forms – from round and angular to avantgarde. Made of pure metal. With one or more spray modes. In chrome or refined in 15 exclusive AXOR FinishPlus surfaces. In perfection.

Design: Phoenix Design, Nendo, Front,  
Barber & Osgerby, Philippe Starck

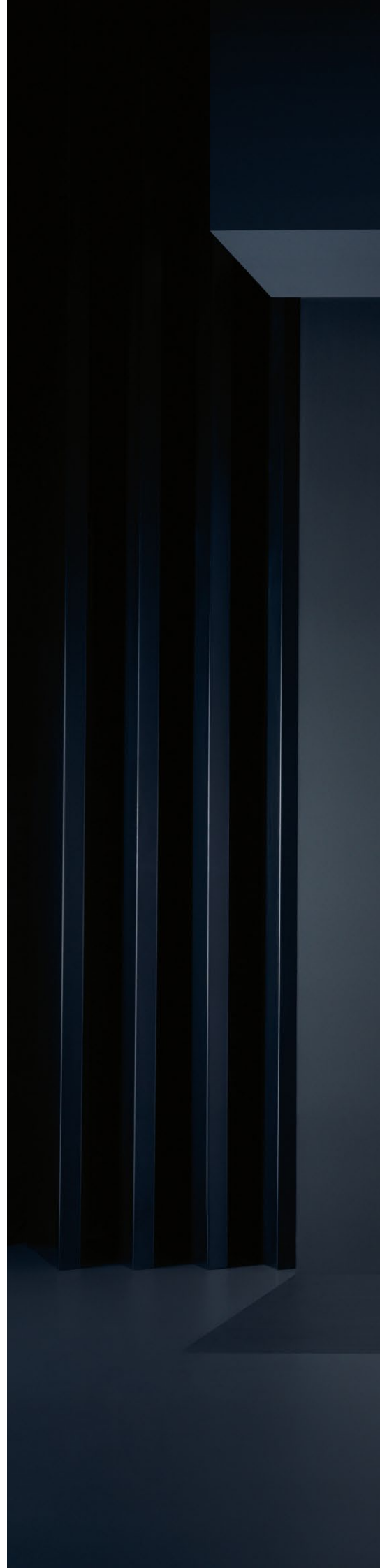





## POWDERRAIN

### GENTLY ENVELOPED. IN PERFECTION.

A soft rain in the shower. Gently enveloping like a protective coat of water. Quiet and soft, yet powerful. A unique feeling. Like a cocoon of pure water.

PowderRain is the result of intensive research. The spray lab experts spent almost six years perfecting it. Pushing the boundaries. Soothing the sensitive skin receptors. To find out just how fine a jet of water can be. For a velvety-soft feeling on the skin.

An unexpected, completely new kind of experience. With the finest silicone nozzles lending water elegance in small drops. Distributed among the smallest openings in a nozzle. Precise. While reducing water consumption at the same time.

PowderRain unfolds its magic in AXOR ShowerHeaven 1200/300 4jet, AXOR overhead shower 350 1jet and AXOR Showerpipe 800. Masterpieces of design and water. In perfection.



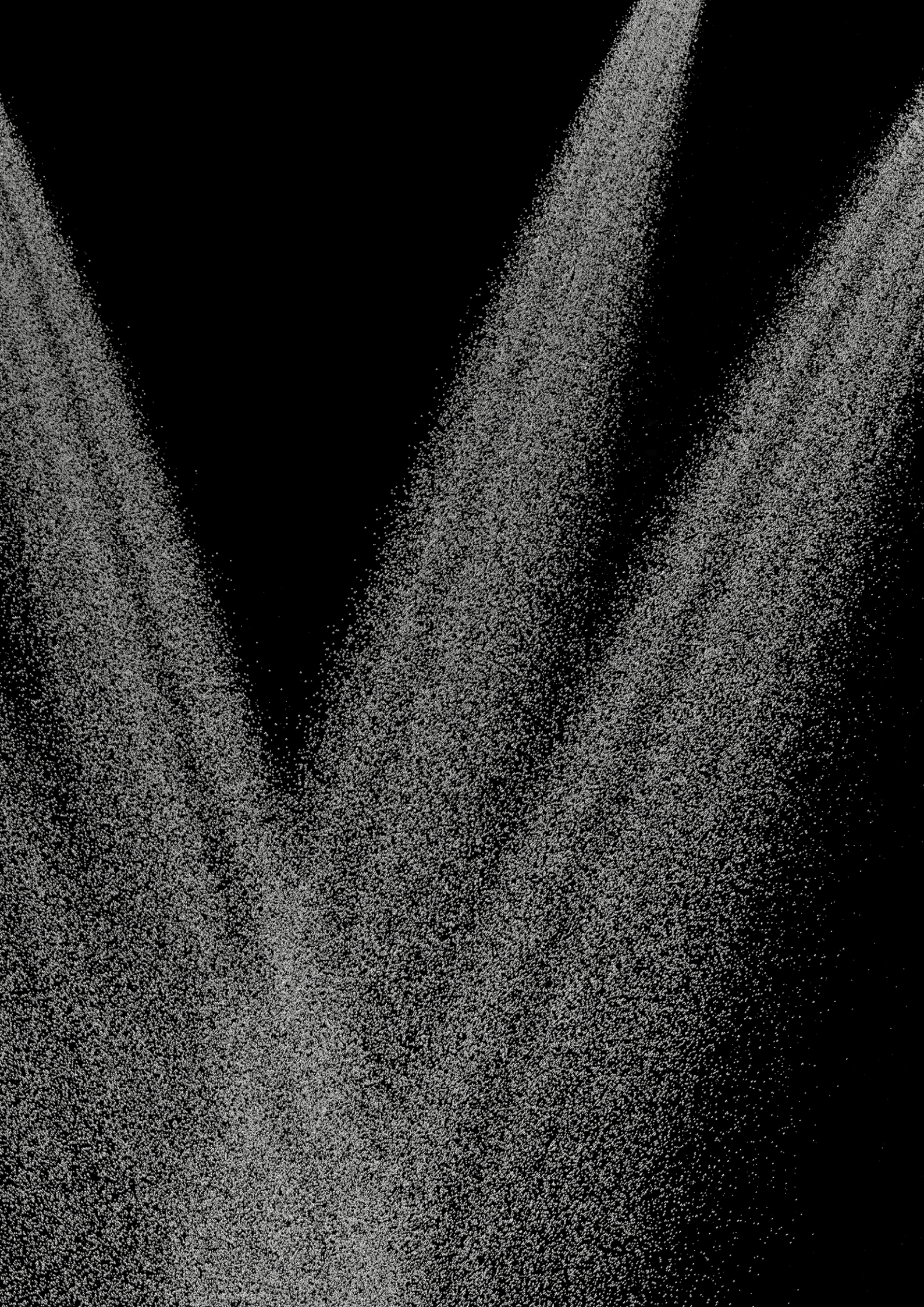



## AXOR SHOWERHEAVEN 1200 / 300 4JET

Luxury taken to a new level. AXOR ShowerHeaven is a new archetype in the shower. With maximum appeal. And scope. Where water takes the stage. And assumes a variety of forms: from revitalising jets to soothing shower rain. Including the gentle PowderRain - the latest AXOR innovation in water design. Precisely distributed drops. Gently enveloping. A cocoon of water. An elegant ballet. Borne of precise technology. That can be adapted optimally to the user. In perfection.

Found on pages 08 and 09 in combination with the Select thermostat module for five outlets. Perfect in form and function. Visually reduced to the minimum. Intuitive in operation. To control all spray modes. Individually or combined.

12

### PRODUCTS (as shown on pages 08 and 09)

ShowerHeaven 1200/300 4jet  
with lighting 2700K  
# 10628000

Basic set  
# 10922180

Thermostatic module Select 670/90  
for 5 functions for concealed installation  
# 18358000

Basic set  
# 18313180

Baton hand shower 2jet  
# 28532000

Shower hose 1.60m  
# 28626000





## SHOWERHEAVEN 1200 / 300 4JET

Unique in every dimension:

Highlights of AXOR ShowerHeaven 1200/300 4jet.

- / A masterpiece featuring the leading AXOR technologies such as the spray innovation PowderRain
- / Shower solution that offers high functional diversity in a reduced design
- / Ceiling installation with concealed basic set and only two connections, creating a sense of weightlessness
- / Four different spray modes - from revitalising jets and soothing shower rain to velvety-soft PowderRain
- / Body jet: sensual, enveloping luxury with the new PowderRain spray mode, covering the body from both sides
- / Users can adjust the body jet to any height to avoid getting their hair wet
- / Rain jet: large area for a perfect shower experience that feels just like summer rain
- / Mono jet: concentrated, soothing relaxing jet for a real spa feeling
- / Resource-friendly use of water: maximum of 30 l/min per 1/2" standard connection
- / Available either with or without indirect LED lighting in two colour temperatures, for atmospheric light in the shower
- / Body made of pure metal
- / AXOR FinishPlus special surfaces fulfil individual wishes
- / Developed by AXOR together with Phoenix Design

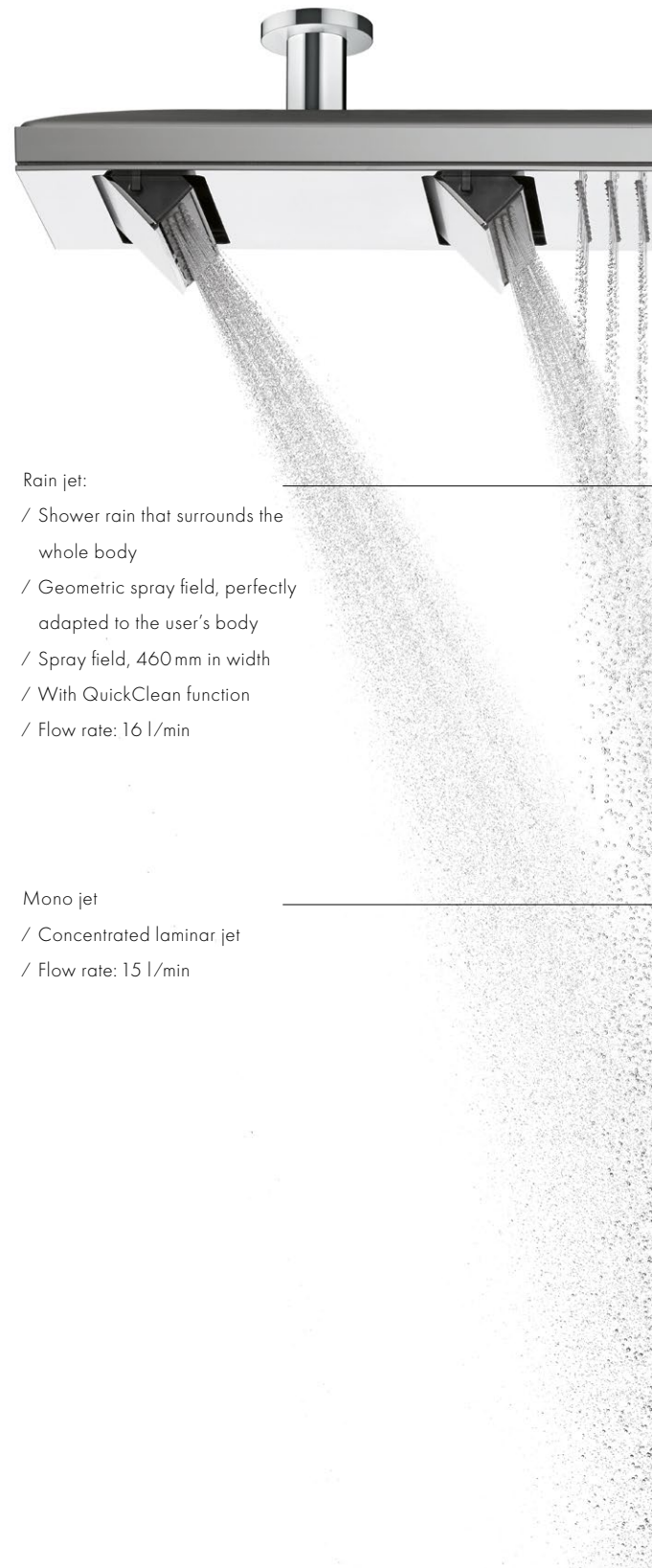

### Rain jet:

- / Shower rain that surrounds the whole body
- / Geometric spray field, perfectly adapted to the user's body
- / Spray field, 460 mm in width
- / With QuickClean function
- / Flow rate: 16 l/min

### Mono jet

- / Concentrated laminar jet
- / Flow rate: 15 l/min

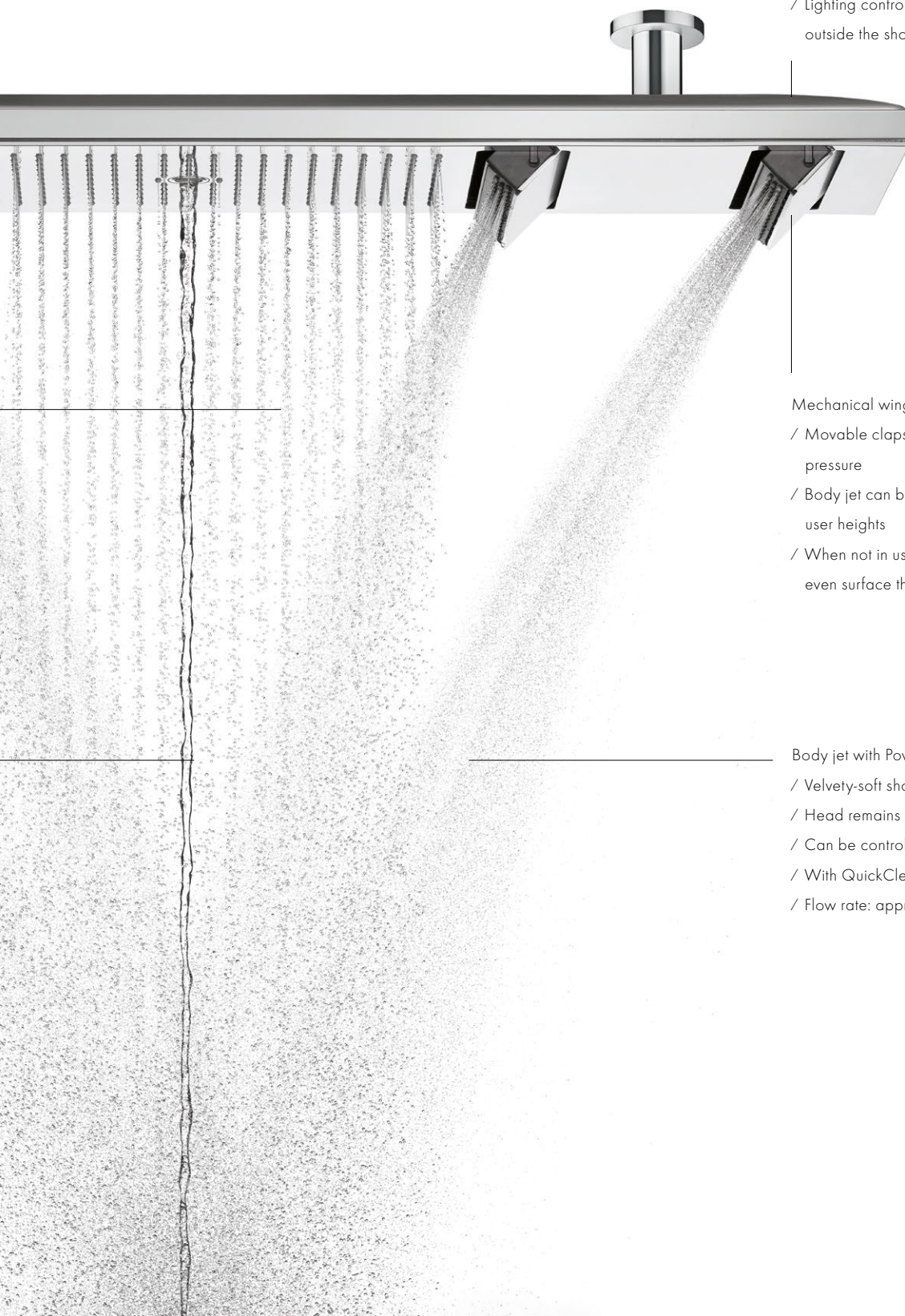

Optional lighting:

- / Indirect light
- / Energy-efficient LED lamps (5W in version 2700K)
- / Power supply: Input voltage 100-240V AC, 50-60Hz/output voltage 24V DC
- / Colour temperature warm white 2700K or neutral white 3700K
- / 125 lm/W light output
- / Including 7 m connection cable
- / Lighting controlled by a separate switch outside the shower

Mechanical wings:

- / Movable claps that open under water pressure
- / Body jet can be angled to suit different user heights
- / When not in use, the flaps close to form an even surface that is ideal for cleaning

Body jet with PowderRain:

- / Velvety-soft shower rain
- / Head remains dry
- / Can be controlled separately
- / With QuickClean function
- / Flow rate: approx. 15 l/min

# AXOR SHOWERHEAVEN 970 / 970 3JET AND AXOR SHOWERCOLLECTION

Every element is luxury squared. Geometric - minimalistic design. The AXOR ShowerCollection is a system. One that can be set up and combined with maximum flexibility. Vertically and horizontally. Or arranged unconventionally on the wall. With three spray modes in the large overhead shower. A shower that serves as a customised spa for individual water orchestration. Especially impressive when combined with AXOR ShowerHeaven 970/970.

## PRODUCTS

---

ShowerHeaven 970/970 3jet  
with lighting  
# 10623800

Thermostatic module 360/120 Square  
for concealed installation  
# 10751000  
Basic set  
# 10750180

Shut-off valve 120/120 Square  
for concealed installation  
# 10972000  
Basic set  
# 10971180

Hand shower module 120/120 Square,  
for concealed installation  
# 10651000  
Basic set  
# 10650180

Shower module 120/120 Square  
for concealed installation  
# 28491000





## AXOR SHOWERHEAVEN 970 / 970 3JET

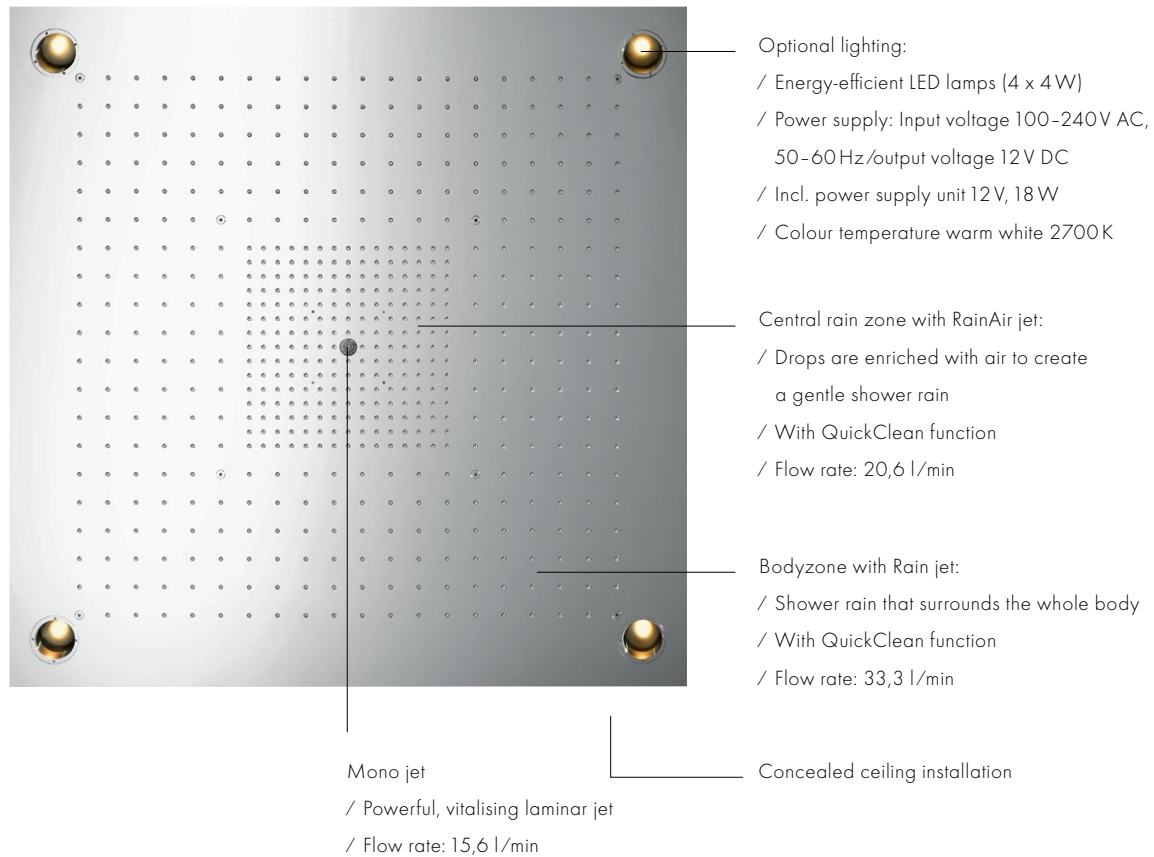

18

Luxury squared:

Highlights of AXOR ShowerHeaven 970/970 3jet.

- / Exceptionally large overhead shower in two sizes (970/970 mm and 720/720 mm) with reduced design
- / Three different spray modes: Rain jet, RainAir jet, Mono jet
- / For concealed ceiling-flush or ceiling-exposed mounting
- / Available either with or without ambient lighting for atmospheric light in the shower
- / Spray disc surface made of polished stainless steel
- / Available in special surfaces on request
- / Developed by AXOR together with Philippe Starck

## AXOR SHOWERCOLLECTION



AXOR ShowerCollection thermostatic module 360/120:

- / Up to three outlets used simultaneously
- / Plate made of pure metal
- / Simple installation and exact alignment

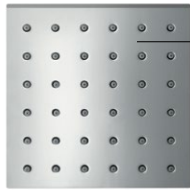

AXOR ShowerCollection 120/120 1jet shower module:

- / Can be used as side or overhead shower - individually or combined
- / Water jets can be adjusted horizontally or vertically
- / Precisely linear installation with just 10 mm between individual modules - predefined by the basic set



AXOR ShowerCollection lighting module 120/120:

- / Atmospheric lighting
- / Can also be used in the shower
- / Concealed installation

Haute couture in perfection:  
Highlights of AXOR ShowerCollection.

- / Modular system of freely installable showers, mixers and accessories such as lighting and loudspeaker modules, turning the shower into a customised spa
- / Flexibly installable side showers for individual water orchestration
- / Can be combined with all AXOR Showers products and all AXOR collections
- / AXOR FinishPlus special surfaces fulfil individual wishes
- / Developed by AXOR together with Philippe Starck









## AXOR OVERHEAD SHOWER 250 / 580 AND 460 / 300 WITH AXOR THERMOSTATIC MODULE SELECT

Geometric clarity. Striking - right down to the very last detail. The defining shape of the rectangle. From the overhead shower to the wall or ceiling plate. Made of pure metal, the jet disc produces a variety of sprays: from the flood jet for gentle neck massages and the concentrated powerful mono jet to the sensual rain sprays - depending on the version. One hundred per cent energisation. One hundred per cent regeneration.

Combined for example with the AXOR thermostatic module Select. The technical counterpart to the element of water. Clear in appearance, impressive in performance. Timeless and elegant. Perfect integration in the room. Intuitively easy to use thanks to its large Select buttons. Precise switching at the touch of a button. Purely mechanical.

21

### PRODUCTS

---

Overhead shower 250/580 3jet

# 35283000

Basic set iBox universal

# 01700180

Thermostatic module Select 600/90

for 4 functions for concealed installation

# 18357000

Basic set

# 18312180

Baton hand shower 2jet

# 28532000

Shower hose 1.60 m

# 28626000

## AXOR OVERHEAD SHOWER 250 / 580



## AXOR OVERHEAD SHOWER 460 / 300

22



Showering in perfection:

Highlights of AXOR overhead shower 250/580 and 460/300.

- / Geometrically clear and striking design language, combined with high functionality
- / Large, rectangular spray disc for wetting the entire body
- / Different versions with up to three spray modes
- / AXOR FinishPlus special surfaces fulfil individual wishes
- / Developed by AXOR together with Phoenix Design

## AXOR THERMOSTATIC MODULE SELECT

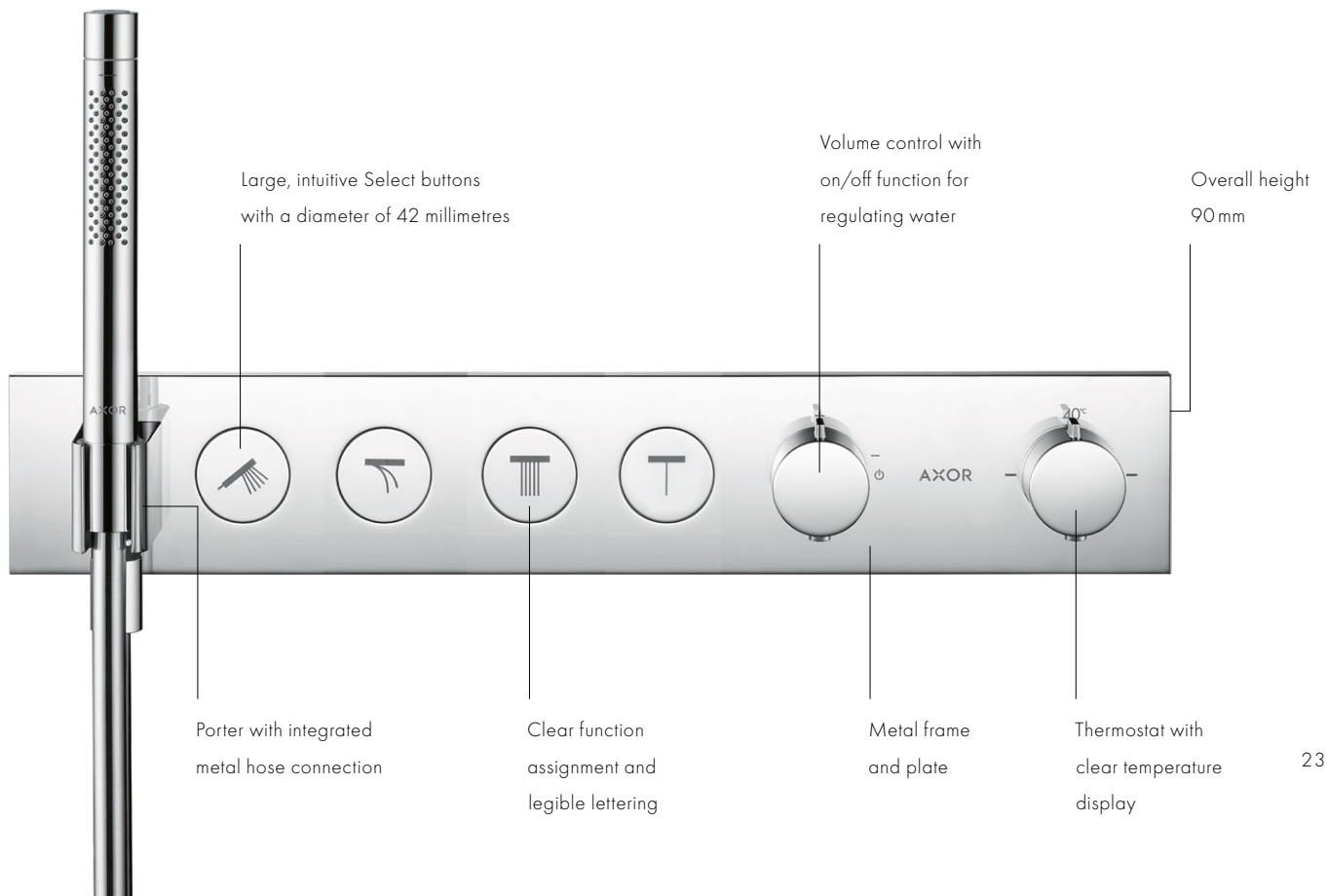

23

Clear in appearance, impressive in user comfort:  
Highlights of AXOR thermostatic module Select .

- / Reduced design with high functional diversity to meet the highest expectations
- / User-friendly and intuitive through Select technology, with large buttons and clear symbols
- / Slim design with a height of 90 mm with a length of 457 mm (two outlets) up to 670 mm (five outlets)
- / Perfect lines through precisely processed metal
- / AXOR FinishPlus special surfaces fulfil individual wishes
- / Developed by AXOR together with Phoenix Design

## AXOR OVERHEAD SHOWER 350 1JET

The epitome of luxury: the AXOR 350 1jet overhead shower. The majesty of the circular design captures the room. Its edges finely milled and turned. Premium craftsmanship in pure metal. The AXOR overhead shower 350 1jet comes with the spray innovation PowderRain. Enveloping the body in fine drops. Like a cocoon. A masterpiece of design and water.

## AXOR THERMOSTATIC MIXER 800 FOR SURFACE/CONCEALED INSTALLATION

Reduction creates a new dimension. The thermostat with premium mirror shelf as a surface-mounted variant. Fusing unseen with the overhead shower. Including Select technology. In this combination, it controls the innovative PowderRain spray mode.

24

### PRODUCTS

---

Overhead shower 350 1jet  
with shower arm  
# 26034000

Thermostatic mixer 800  
for exposed/concealed installation  
# 45440000  
Basic set  
# 45442180

Baton hand shower 2jet  
# 28532000

Shower hose 1.60 m  
with volume control  
# 28128000



## AXOR OVERHEAD SHOWER 350 1JET

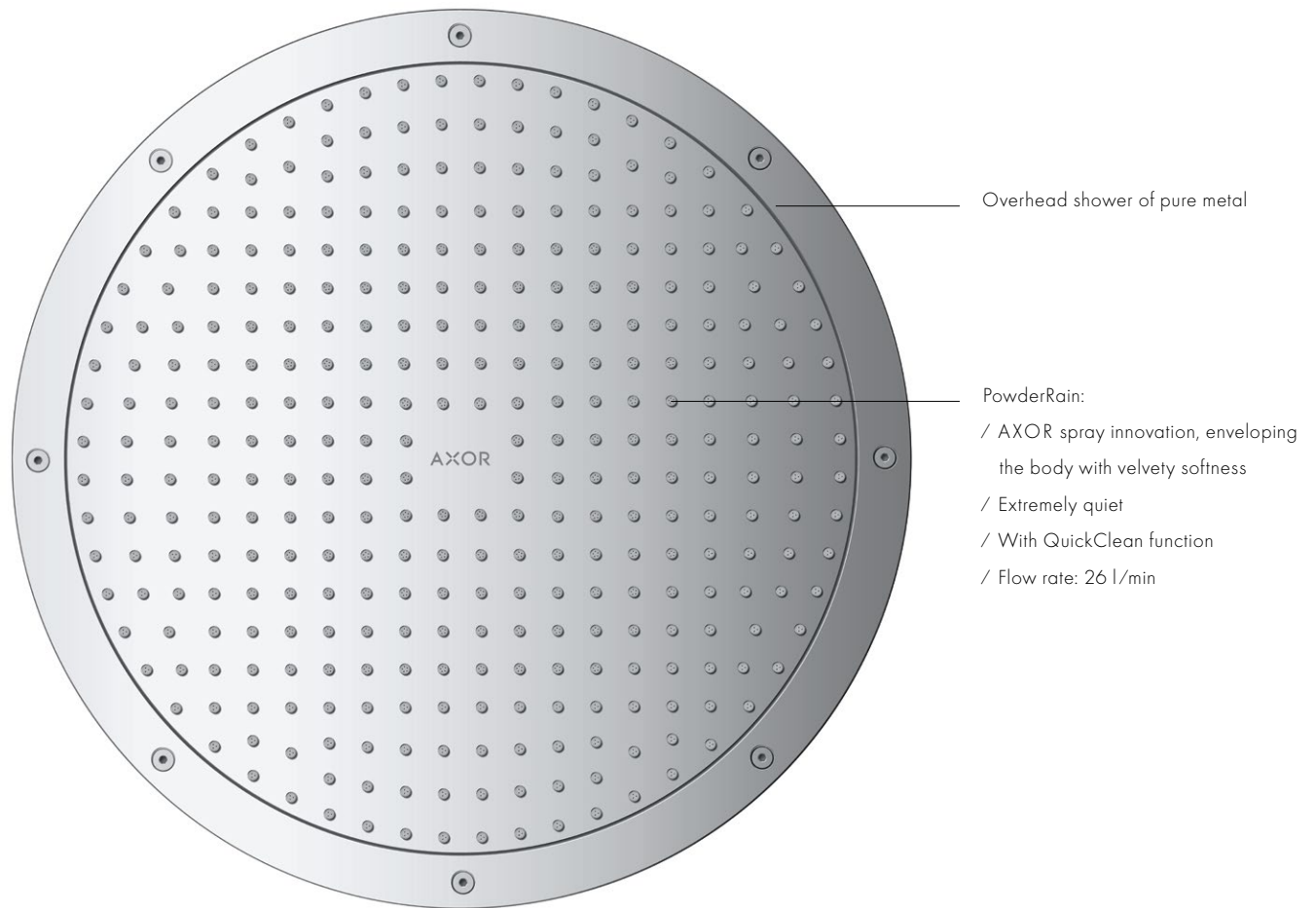

26

The epitome of perfection:

Highlights of AXOR overhead shower 350 1jet

- / High-end overhead shower through premium craftsmanship and the AXOR spray innovation PowderRain
- / Clear, circular geometry of the overhead shower
- / With the spray innovation PowderRain
- / Available for ceiling or wall installation
- / Manufactured of a massive metal block with precisely milled edges
- / AXOR FinishPlus special surfaces fulfil individual wishes
- / Developed by AXOR together with Phoenix Design

## AXOR THERMOSTATIC MIXER 800

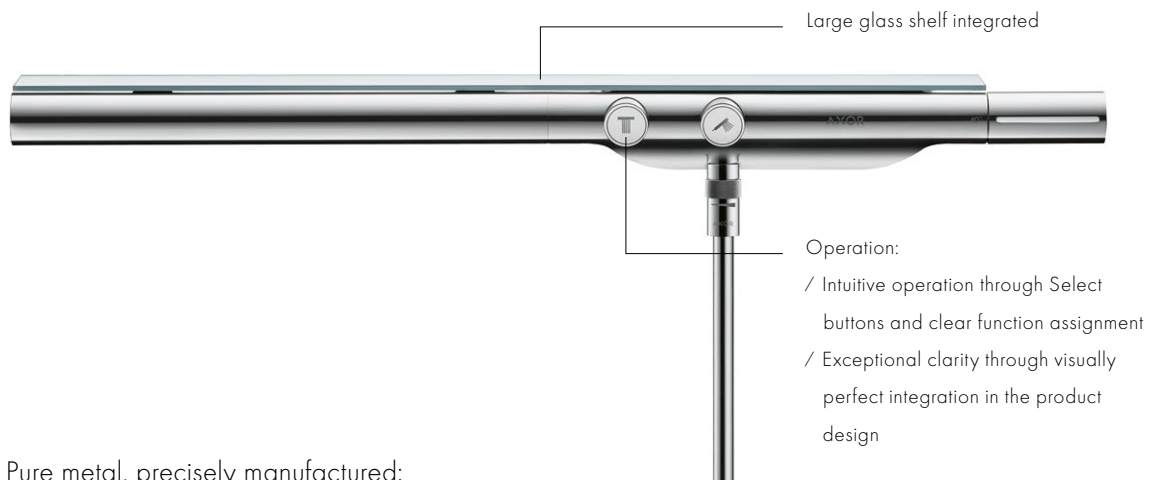

Pure metal, precisely manufactured:  
Highlights of AXOR thermostatic mixer 800.

- / Consequently purist form - immaculate to the very last detail through premium craftsmanship
- / Select technology for intuitive operation of outlets
- / Available as a version for exposed or exposed/concealed installation
- / AXOR FinishPlus special surfaces fulfil individual wishes
- / Shower solution rounded off perfectly with a separately available shower hose with volume control
- / Developed by AXOR together with Phoenix Design

27

## AXOR SHOWER HOSE WITH VOLUME CONTROL

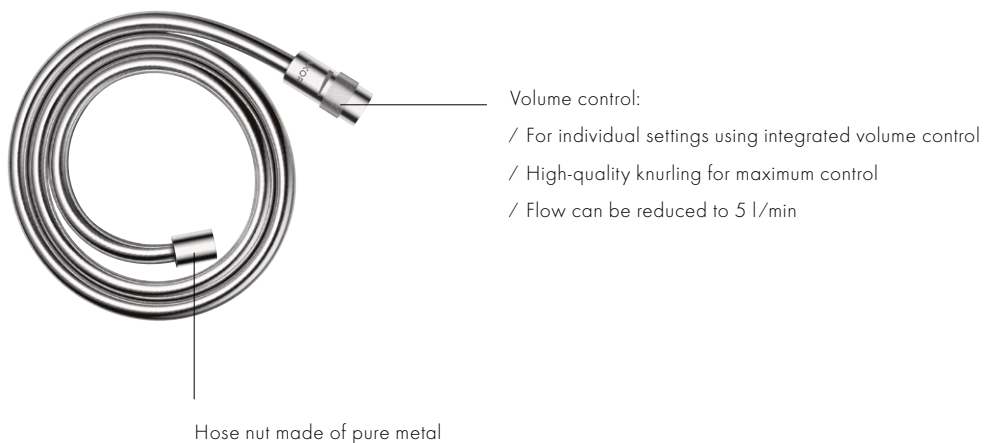







## AXOR SHOWERPIPE 800

A lavish control system for the water's journey. In the purist pipe design. The original means of transporting water. Newly interpreted with two Select buttons for easy and precise operation of the overhead or hand shower. With a thermostat, and a spacious shelf made of the finest mirror glass. Water design in its most exquisite form: the innovative, gentle PowderRain. Unique lightness. In perfection.

### PRODUCTS

---

Showerpipe 800  
# 27984000

## AXOR SHOWERPIPE 800

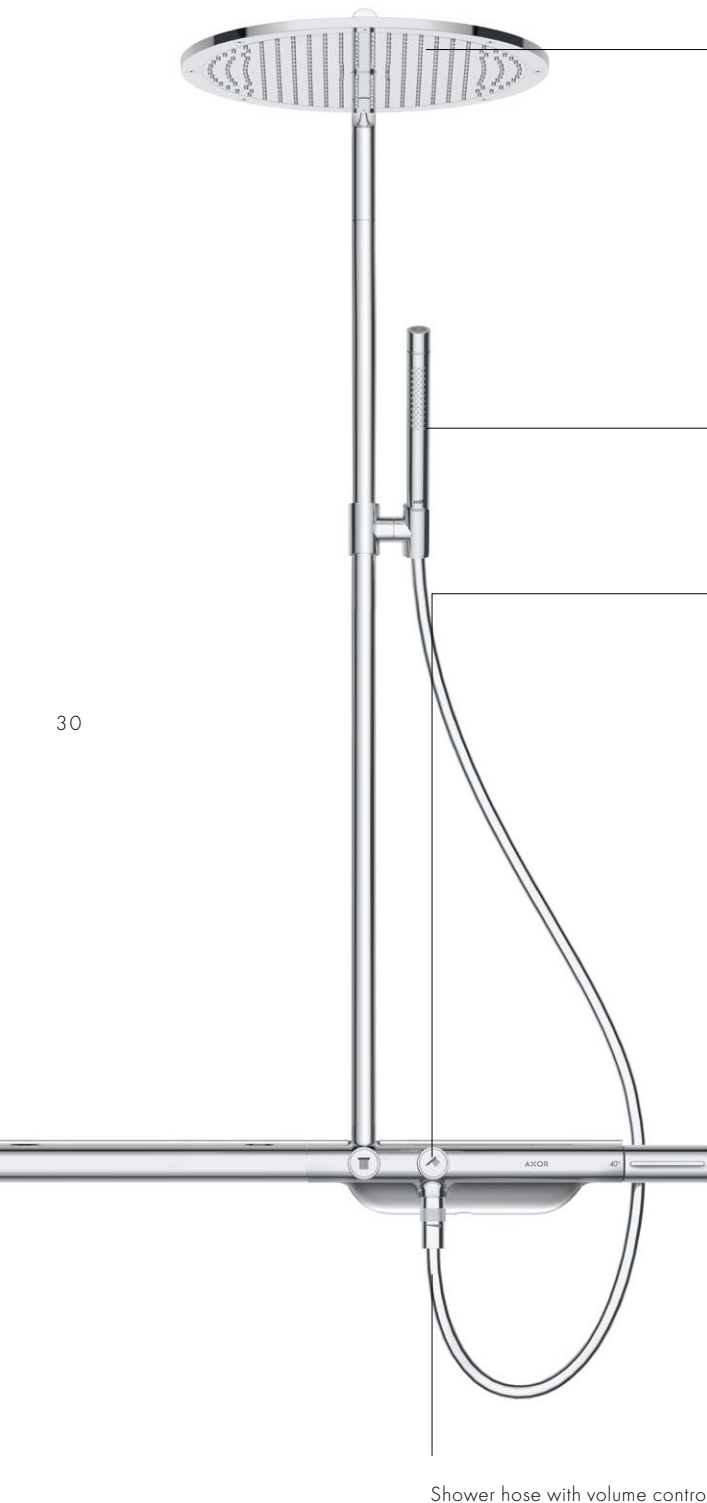

AXOR overhead shower 350 1jet:  
 / Overhead shower of pure metal  
 / Swivable shower arm  
 / AXOR spray innovation PowderRain,  
 which envelops the body in ultra-quiet  
 velvety softness  
 / With QuickClean function  
 / Flow rate: 22 l/min

AXOR hand shower 2jet:  
 / Positioned in high-quality metal slider

AXOR thermostatic mixer 800:  
 / Select buttons for intuitive operation  
 with clear allocation of functions  
 / Perfect integration in the product design  
 / Generous glass shelf area

Avantgarde, pipe design in perfection:  
 Highlights of AXOR Showerpipe 800.

/ The holistic system solution, consisting of  
 thermostat, overhead shower and hand  
 shower in the purist pipe design  
 / Easy to use due to Select technology  
 / AXOR overhead shower 350 1jet with  
 the spray innovation PowderRain envelops  
 the body with water  
 / Shower hose with volume control  
 / AXOR FinishPlus special surfaces fulfil  
 individual wishes  
 / Developed by AXOR together with  
 Phoenix Design

Shower hose with volume control





## AXOR ONE THERMOSTATIC MODULE AND HAND SHOWER 2JET

Interaction as a design principle. AXOR One fuses form and function to make a confident statement. A monolithic control element in the shower. Flat. Soft. Planar. Just the bare necessities. Large paddles control the shower jets. With innovative Select technology. For operating the shower jets intuitively.

The perfect addition: AXOR One hand shower 2jet with Select technology, users can switch between spray modes at the touch of a button - from gentle shower jets to a wide, soft band of water. Interactive design. In perfection.

### PRODUCTS

---

One Thermostatic module,  
for 2 outlets, for concealed installation  
# 45712000

Basic set  
# 45710180

Overhead shower 350 1jet  
with ceiling connector  
# 26035000

Ceiling connector 300 mm  
# 26433000

One hand shower 2jet  
# 45720000

One porter unit  
# 45723000

Shower hose 1.60 m  
# 28626000

## AXOR ONE THERMOSTATIC MODULE

## Temperature regulation:

- / Precisely controllable with the large, cylindrical knob
- / Safety stop function limits temperature to 40 °C
- / Maximum temperature limitation adjustable



34

## Outlet control:

- / Large Select paddles turn the water on and off easily
- / Full control when operating with fingers, hands or even elbows
- / Up to three outlets can be activated - separately or at the same time
- / A porter can be added

## Volume control:

- / For economical water consumption
- / Volume control reduces water flow continuously by up to 50% - depending on flow volume and installation situation

## Operation:

- / Large symbols on the paddles indicate clearly which outlet is being used
- / The paddle symbols can be applied easily after installation

## Interaction as a design principle:

## Highlights of AXOR One thermostatic module.

- / Confident unit of form and function
- / All functions combined in a single element
- / Intuitive, manual operation
- / Precise volume control for reducing water consumption continuously
- / AXOR FinishPlus special surfaces fulfil individual wishes
- / Developed by AXOR together with Barber & Osgerby

## AXOR ONE HAND SHOWER 2JET

- Select button:  
 / Users can switch between spray modes quickly and easily using the Select button
- Spray modes:  
 / Hand shower with normal jet and flood jet  
 / Normal jet for showering the body  
 / Flood jet for concentrated neck or head massage  
 / With QuickClean function  
 / Flow rate: max. 12 l/min

- Hand shower:  
 / Uniquely striking design  
 / Fully integrated handle



A wide band of water:

Highlights of AXOR One hand shower 2jet.

- / Unique design of hand shower combines edges and curves to form a perfect unit
- / The perfect addition - for example to the AXOR One thermostatic module
- / High-quality and precisely manufactured metal body
- / Intuitive operation using Select technology
- / Two spray modes - normal jet and flood jet
- / Horizontally positioned hand shower enhances the revitalising wellness effect of the flood jet
- / AXOR FinishPlus special surfaces fulfil individual wishes
- / Developed by AXOR together with Barber & Osgerby



AXOR OVERHEAD  
SHOWERS









## AXOR LAMPSHOWER 275 1JET

A repository of light and water. Dissolving the boundaries of space. AXOR LampShower. Every bit as extraordinary: its water design. A wide wreath of rain creates a spray that surrounds the body with water. A whole new interpretation of showering. Can be combined with many AXOR collections. In perfection.

### PRODUCTS

---

LampShower 275 1jet  
with shower arm  
# 26031000

AXOR Starck Thermostatic mixer,  
with shut-off valve, for concealed installation  
# 10700000  
Basic set iBox universal  
# 01700180



## AXOR LAMPSHOWER 275 1JET

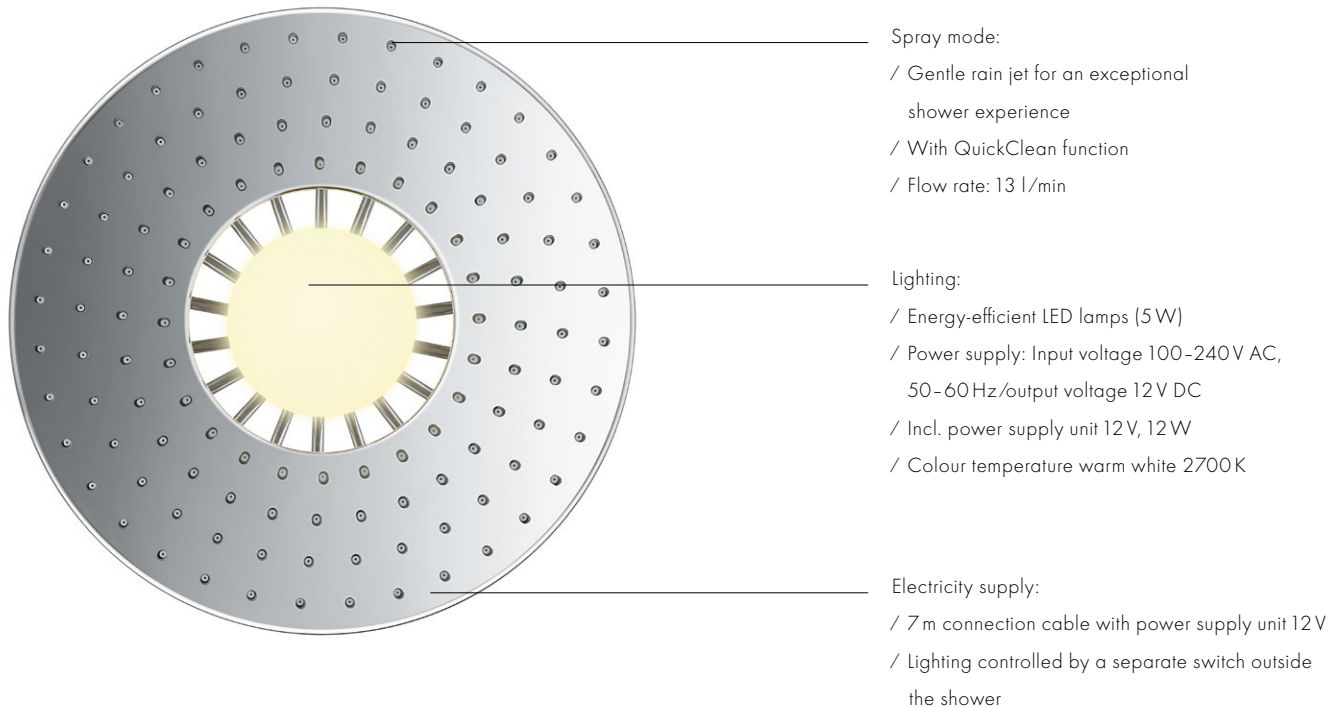

40

A source of light and water.

Highlights of the AXOR LampShower 275 1jet.

- / Fascinating effect through intricate supply lines - a perfect example of the innovative strength of AXOR
- / The lighting creates a homely atmosphere in the shower
- / Swivable shower arm for ideal spray direction
- / Wide wreath of rain creates a spray that surrounds the body completely
- / With wall or ceiling connection
- / AXOR FinishPlus special surfaces fulfil individual wishes
- / Developed by AXOR together with Nendo

Ball joint:  
/ Can be adjusted by 5° for  
the ideal spray direction

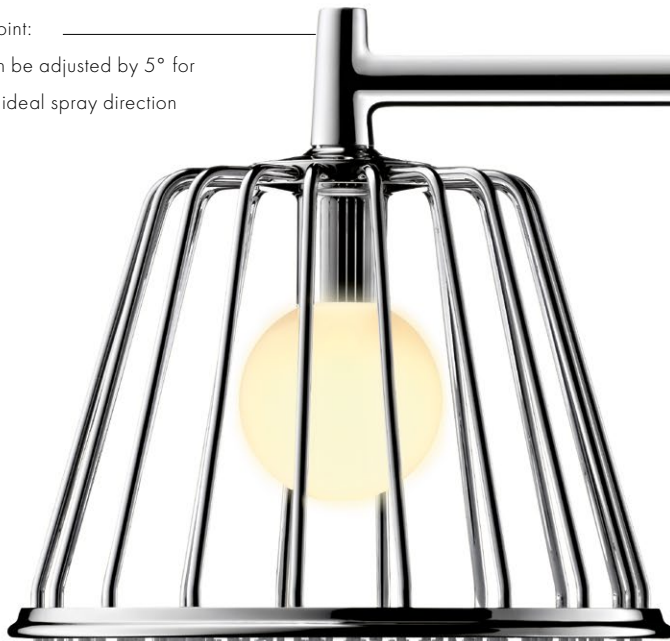

Shower arm:  
/ Length 380 mm, can be swivelled horizontally by 150°  
/ Ideal adjustment of shower jet

Spray disc:  
/ Made of pure metal  
/ Diameter 275 mm  
/ Can be removed for easy cleaning

41

AXOR FinishPlus:  
/ Two of 15 exclusive special  
surfaces



## AXOR SHOWERPIPE

The aesthetics of technology. Nothing is concealed. Steel pipes, sockets, valves. A horizontally swivable shower arm for the overhead shower. Ideal for any position. In combination with the hand shower. An archaic funnel. That provides water in two spray modes. Authentic industrial design. In perfection.

### PRODUCTS

---

Showerpipe  
# 26020000

42

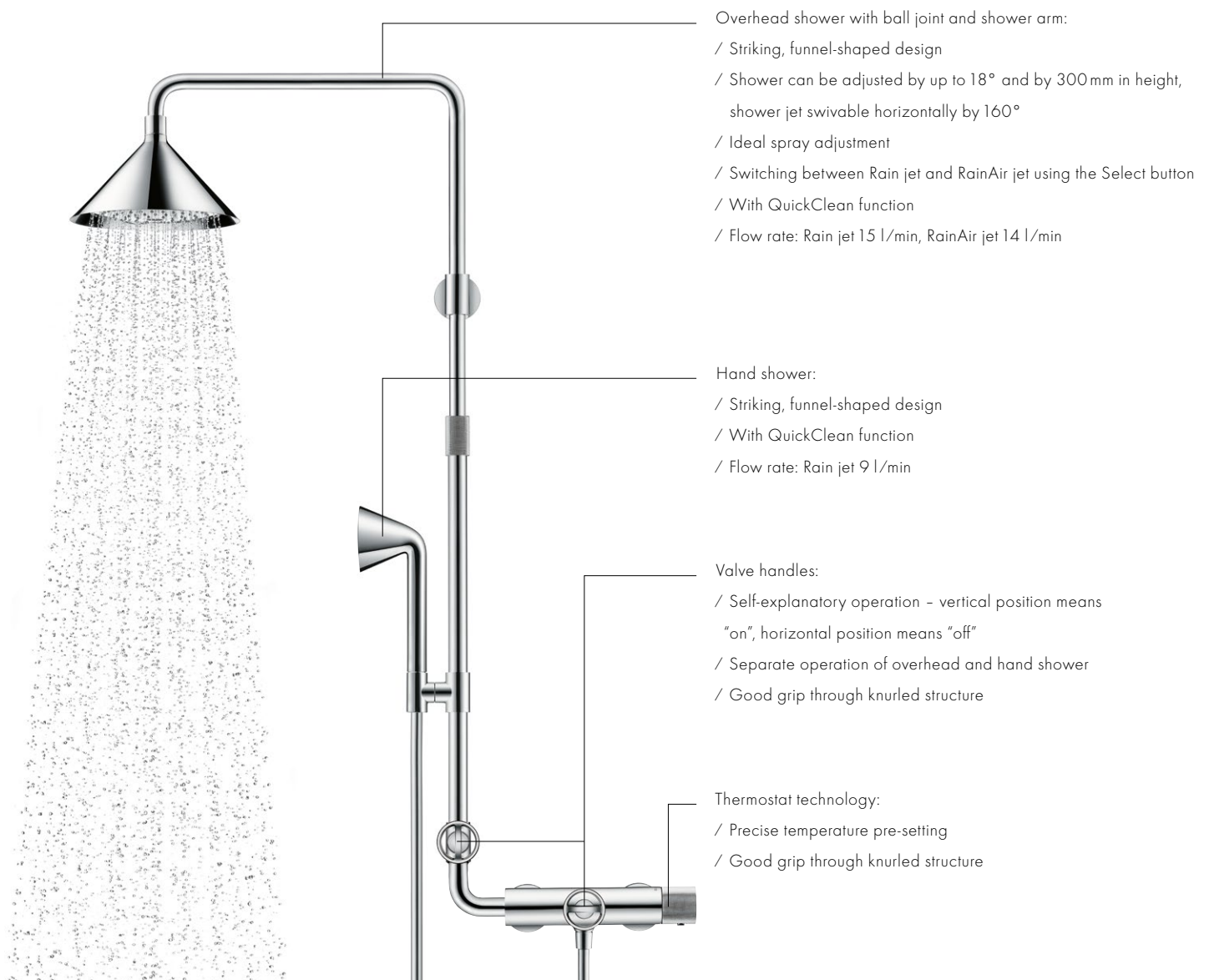

Overhead shower with ball joint and shower arm:

- / Striking, funnel-shaped design
- / Shower can be adjusted by up to 18° and by 300mm in height, shower jet swivable horizontally by 160°
- / Ideal spray adjustment
- / Switching between Rain jet and RainAir jet using the Select button
- / With QuickClean function
- / Flow rate: Rain jet 15 l/min, RainAir jet 14 l/min

Hand shower:

- / Striking, funnel-shaped design
- / With QuickClean function
- / Flow rate: Rain jet 9 l/min

Valve handles:

- / Self-explanatory operation - vertical position means "on", horizontal position means "off"
- / Separate operation of overhead and hand shower
- / Good grip through knurled structure

Thermostat technology:

- / Precise temperature pre-setting
- / Good grip through knurled structure





Industrial design in perfection:  
Highlights of AXOR Showerpipe.

- / Design object with industrial character
- / Complete shower solution consisting of thermostatic mixer, overhead shower and hand shower
- / Thermostatic mixer with self-explanatory valve handles
- / Overhead shower with two spray modes: Rain jet and RainAir jet
- / Hand shower integrated harmoniously in the design
- / Shower jet can be adjusted horizontally and vertically and the angle is also adjustable for an individual shower experience
- / Select technology for changing between spray modes intuitively
- / AXOR FinishPlus special surfaces fulfil individual wishes
- / Developed by AXOR together with Front Design

## AXOR SHOWERSELECT WITH AXOR CITTERIO E SHOWER SET

One button. Perfectly integrated. Revelation of simplicity. AXOR ShowerSelect makes usage intuitive. And increases the comfort of showering. The Select button: in classy black. Brought to perfection in combination with the AXOR Citterio E shower set. Classic and modern. Balanced right down to the last detail.

Revelation of simplicity.  
Highlights of AXOR ShowerSelect.

- / Shower solution that captivates users through its clear design and high technical precision
- / User-friendly and intuitive through Select technology
- / Three different escutcheon forms (square, round and softcube) - made of high-quality metal, just like the handle
- / Different thermostat variants available for up to four different outlets
- / AXOR FinishPlus special surfaces fulfil individual wishes
- / Developed by AXOR together with Phoenix Design

44



- Spray disc:
  - / High-quality chrome finish
- Spray modes:
  - / Rain, RainAir, WhirlAir
  - / With QuickClean function
  - / Flow rate: 16 l/min
- Select button:
  - / Select button for intuitively switching to the desired spray mode

## PRODUCTS

AXOR Citterio E shower set  
# 36735000

ShowerSelect Thermostatic mixer  
Softcube, for 1 outlet,  
for concealed installation  
# 36705000  
Basic set iBox universal  
# 01700180

FixFit hose connection  
# 27451000

- AXOR ShowerSelect thermostatic mixer:
- / Clear and elegant Select buttons for intuitive operation
  - / Elegant, cylindrical thermostat handle for setting temperatures
  - / Clear temperature display





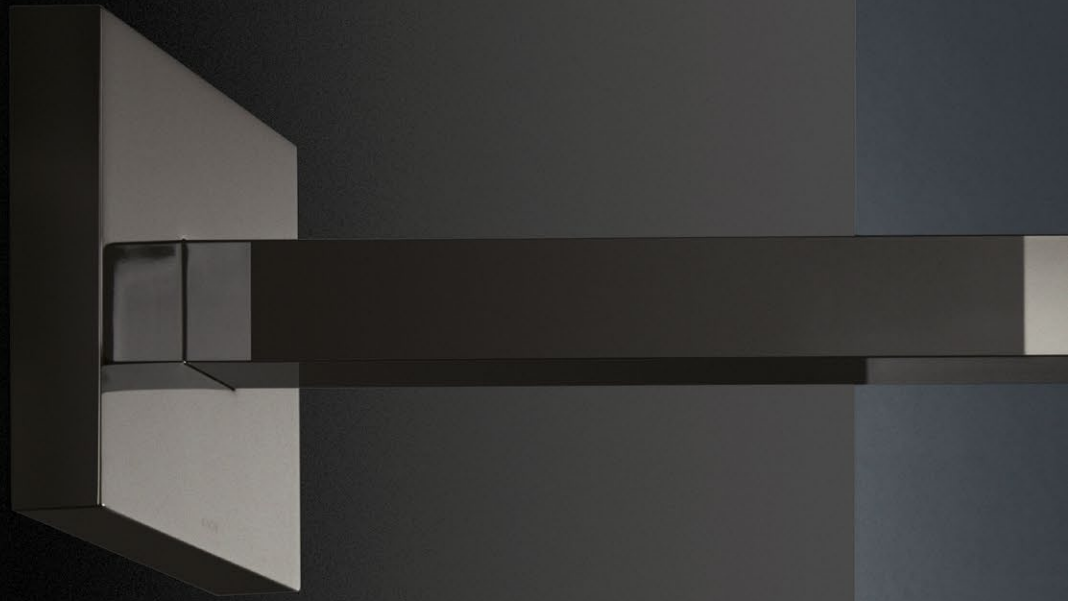

AXOR INDIVIDUALISATION  
AND INSPIRATION





# AXOR FINISHPLUS

REFINED.  
IN PERFECTION.

Brilliant. Robust. Durable. AXOR FinishPlus surfaces are exceptional. Ten times as hard as electroplated mixers. With an outstanding colour brilliance. Extremely resistant. Created by using the highly complex physical vapour deposition (PVD) method

for coating surfaces. Zirconium molecules evaporate. In a vacuum. Produced to high quality standards. Ultraprecise. Particularly impressive in the brushed variants.



Polished chrome  
-020



Brushed chrome  
-260



Polished gold-optic  
-990



Brushed gold-optic  
-250



Polished nickel  
-830



Brushed nickel  
-820



Polished red gold  
-300



Brushed red gold  
-310



Polished bronze  
-130



Brushed bronze  
-140



Polished black chrome  
-330



Brushed black chrome  
-340



Polished brass  
-930



Brushed brass  
-950



Stainless steel-optic  
-800

AXOR FinishPlus. Available in 15 exclusive special surfaces. Also based on individual specifications. Theoretically, any preferred colour is possible. In practice, a feasibility test is conducted by AXOR experts first. To make a special product into something quite unique.



## AXOR SIGNATURE

UNIQUE PRODUCTS.  
IN PERFECTION.

The fascination for the exceptional. The desire for more individuality. AXOR Signature turns bathroom mixers into something truly unique. A design object into a completely personal shower. Something special into something unique. Geared towards the needs and tastes of the customer. Lengthening, shortening, refining, lettering – these are the exclusive services provided by AXOR Signature.

The perfection of the unique products takes place at the AXOR workbenches in Germany. With the utmost in care and precise craftsmanship. So that a unique product emerges. Exceeding even the customer's expectations. In any quantity required. Meeting industrial standards. At the highest technical level. In perfection.

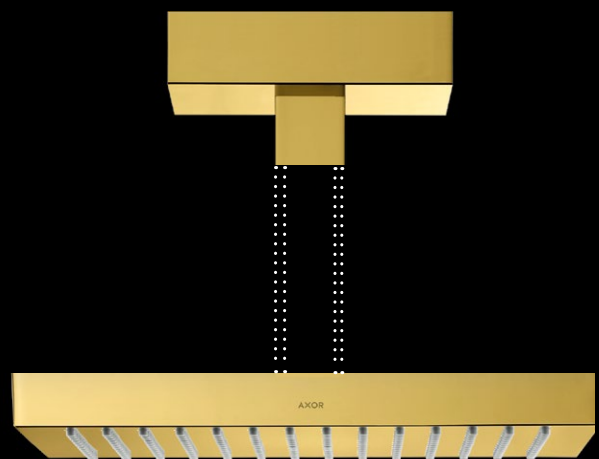

## SPA IN THE FOUR SEASONS HOTEL, MILAN.

### AN OASIS OF LUXURY.

Classy. Golden. Warm. The spa in the five-star Four Seasons Hotel in Milan. An elegant wellness oasis measuring over 800 square metres. Formerly a magnificent vaulted cellar. Today a temple for the senses. With a pool and quiet areas, with an atmospheric fitness and beauty area.

The ambience. Sets the highest standards in the bathroom. A special kind of architecture. Exquisite interior design. Perfection in the light concept. The standards for materials are equally high: natural stone, exquisite wooden surfaces, decor that is fascinating to the touch.

Making its mark even in this environment: AXOR mixers and shower jets. The expectations go far beyond design language and object quality. Extending to exclusive surfaces. They provide additional radiance to luxurious bathrooms.

For the Four Seasons AXOR created mixers, showers and accessories in exclusive AXOR FinishPlus special surfaces. Polished and brushed gold optic. They make the spa a perfect example of luxurious perfection taking centre stage. Created by designer and architect Patricia Urquiola.



## SPA IN THE FRUTT FAMILY LODGE IN THE SWISS ALPS.

### GOLDEN MOMENTS.

A resort like a rock. One with the surrounding mountain panorama. Situated on a high plateau in the Swiss canton of Obwalden. 1,920 metres above sea level. An oasis for travellers all year round. But particularly in the winter when the mountains are covered in a magical white.

52 The spa forms a pleasing contrast to the winter landscape. Located spaciously at the base of the building complex. Perfectly mysterious. Cut off from the outside world. A spa area that calls to mind oriental hammams. That plays with light and shade. With both darkened nooks and light-flooded areas.

Here is where AXOR mixers and shower jets truly make their mark. Refined through special surfaces. In brushed gold. Fitting well in a spa context is the well-like AXOR Starck V mixer with its characteristic vortex. Adding the perfect finishing touches to the shower areas is the AXOR LampShower. Bathing users in a sensual light. The overhead showers are accompanied by AXOR Citterio thermostatic mixers with cross handles. Like a precious gem on the wall.

A perfect space that already exudes relaxation. Soothing the soul. Creating an unmistakably warm atmosphere. Enhanced by an AXOR FinishPlus special surface. A uniform touch of colour that gives off endless radiance.







Australia – Hansgrohe Pty Ltd. / Level 1 / 123 Camberwell Rd / East Hawthorn / Victoria 3123  
Tel. +61 3 9811 9971 / info@hansgrohe.com.au / hansgrohe.com.au

Belgium – Hansgrohe N.V. / Riverside Business Park / Internationalelaan 55 K / B-1070 Brussel  
Tel. +32 02 5430140 / Fax +32 02 5379486 / info@hansgrohe.be / axor-design.be

Croatia – Hansgrohe d.o.o. / Horvatova 82 / HR-10010 Zagreb  
Tel. +385-1-56-30-800 / Fax +385-1-56-30-899 / info@hansgrohe.hr / hansgrohe.hr

Cyprus – Hansgrohe Middle East & Africa Ltd. / Pentadakilou Street 2 / Office 104 / 7101 Larnaca (Aradippou)  
Tel. +357 22 441 370 / Fax +357 22 441 374 / me.support@hansgrohe.com / hansgrohe-middleeast.com

Dubai – Hansgrohe SE DMCC Branch / Swiss Tower, Cluster Y / Jumeirah Lakes Towers, Office 1904 / PO Box 34216  
Tel. +971 4 448 0200 / Fax +971 4 448 0299 / customerservice.mea@hansgrohe.com / hansgrohe-middleeast.com

Estonia – Hansgrohe Eesti / Mäealuse 2/1 / 12618 Tallinn  
Tel. +372 6826829 / info@hansgrohe.ee / hansgrohe.ee

Finland – Hansgrohe SE / Helsinki Branch Office / Arabiankatu 12 / FIN-00560 Helsinki  
Tel. +358 (0) 207 931340 / info@hansgrohe.fi / hansgrohe.fi

Hungary – Hansgrohe Kft. / Forgách utca 11-13 / 1139 Budapest  
Tel. +36 1 2369090 / info@hansgrohe.hu / hansgrohe.hu

India – Hansgrohe India (Pvt.) Ltd. / Office No. 701 / Lunkad Sky Station / Viman Nagar / Pune – 411014 Maharashtra / India  
Phone No. +912066259500 / info@hansgrohe.in / hansgrohe.in

Japan – Hansgrohe Japan K.K. / Tennozu First Tower 2F / 2-2-4 Higashi Shinagawa / Shinagawa-ku / Tokyo 140-0002  
Tel. +81 3 5715-3073 / Fax +81 3 5715-3088 / info@hansgrohe.co.jp / hansgrohe.co.jp

Latvia – Hansgrohe Latvijas pārstāvniecība / SIA Aqua Studio / Raiņa iela 14 / 3913 Iecava  
Tel. +371 9229029 / info@hansgrohe.lv / hansgrohe.lv

Lithuania – Hansgrohe atstovybė / Santoza / Ulonų g. 5 / 08240 Vilnius  
Tel. +370 5 2043291 / info@hansgrohe.lt / hansgrohe.lt

Netherlands – Hansgrohe / Handelsweg 45 / 1525 RG Westknollendam  
Tel. +31 75 646 1400 / info@hansgrohe.nl / axor-design.com

South Africa – Hansgrohe South Africa (pty) Ltd. / 30 Archimedes Street / Kramerville / Johannesburg 2090  
Tel. +27 11 445 0000 / Fax +27 11 445 0199 / sales@hansgrohe.co.za / hansgrohe.co.za

Portugal – Hansgrohe / Riera Can Pahissa, 26 / 08750 Molins de Rei  
Tel. +34 93 6803900 / Fax +34 93 6803909 / info@hansgrohe.pt / hansgrohe.pt

Singapore – Hansgrohe Pte. Ltd. / 69 Mohamed Sultan Road / Singapore 239015  
Tel. +65 6884 5060 / Fax +65 6884 5071 / info@hansgrohe.com.sg / hansgrohe.com.sg

United Kingdom – Hansgrohe Limited / Units D1 and D2 / Sandown Park Trading Estate / Royal Mills / KT10 8BL Esher Surrey  
Tel. +44 (0) 1372 472 001 / Fax +44 (0) 1372 470 670 / customerservice@hansgrohe.co.uk / pro.hansgrohe.co.uk



# AXOR



AXOR / Hansgrohe SE  
Austraße 5-9  
77761 Schiltach  
Germany

[info@axor-design.com](mailto:info@axor-design.com)  
[axor-design.com](http://axor-design.com)



en-AXOR Showers / Subject to technical alterations and colour differences due to the printing process.  
Form-Nr. 84.090.428 / 8/17/21.69 / Printed in Germany / Printed on 100% chlorine free bleached paper.