

Creative design



organizer/listino 2023

FLORIM È CERTIFICATA B CORP

FLORIM IS
B CORP
CERTIFIED

Guardiamo al business come una forza positiva in grado di generare profitto e allo stesso tempo creare un impatto virtuoso sulle persone e sull'ambiente. Da sempre.

Le nostre scelte, giorno dopo giorno, ci hanno portato a migliorare il nostro modo di fare impresa.

We conceive the business as a positive force able to generate profits and at the same time create a virtuous impact on people and the environment. Since forever.

Our choices, day after day, have led us to improve our way of doing business.

COSA SIGNIFICA ESSERE B CORP?

Ci siamo misurati con i **più alti standard di performance sociale e ambientale** e dopo un lungo e rigoroso processo di verifica **siamo diventati B Corp.**

Le aziende che riescono a ottenere questa certificazione sono le più evolute al mondo in termini di impatto positivo sia sociale che ambientale.

Costituiscono un movimento globale di 'Purpose Driven Businesses' che ha l'obiettivo di diffondere un nuovo **paradigma economico**, che vede le imprese come protagoniste nel **rigenerare la società.**



Guarda il video *"Essere sostenibile è una scelta quotidiana"* con i volti di alcune delle "persone Florim" che ogni giorno contribuiscono a rendere l'azienda sempre più responsabile.
Watch the video "Being sustainable is a daily choice" with the faces of some of the "Florim people" who contribute to making the company even more responsible, every day.

WHAT DOES IT MEAN TO BE B CORP?

*We vied with the **highest social and environmental performance standards**, and after a long and scrupulous verification process, **we became B Corp.***

Companies that succeed in obtaining this certification are the most evolved in the world in terms of their positive social and environmental impact.

*They constitute a global movement of 'Purpose Driven Businesses' whose aim is to diffuse a **new economic paradigm**, whereby companies are the drivers of **social regeneration.***

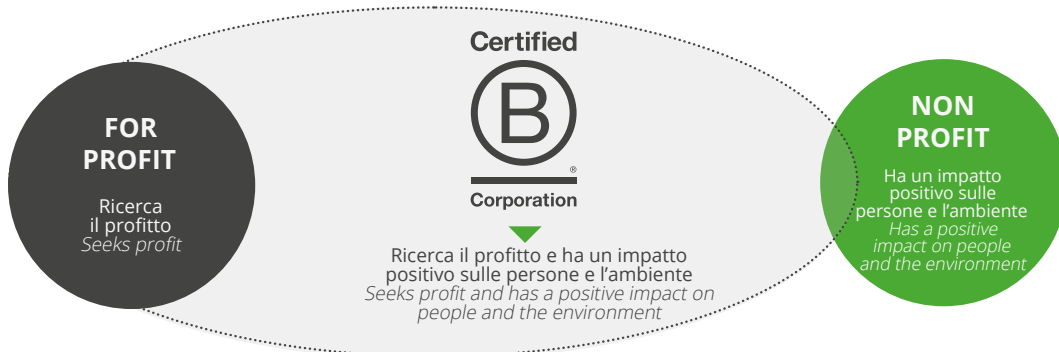

BUSINESS RIGENERATIVO

È in corso un **cambiamento culturale** epocale di cui siamo orgogliosi di essere parte. Uno dei principi fondamentali di tutte le B Corp è quello di adottare un business rigenerativo che si contrappone a quello estrattivo.

Rigenerare significa non solo diminuire l'impatto sulla natura e sull'ambiente che ci circonda, ma addirittura produrre effetti positivi, creando valore condiviso nella società e rigenerando la biosfera.

Diventano B Corp solo quelle aziende che misurano il loro impatto complessivo attraverso il Benefit Impact Assessment (BIA) superando il punteggio di 80 (in una scala da 0 a 200) ed entrando così in una élite di imprese **rigenerative**. Chi non supera questa soglia viene considerata **azienda estrattiva** ovvero per funzionare consuma risorse economiche, sociali e ambientali superiori di quanto sia in grado di generare come output.

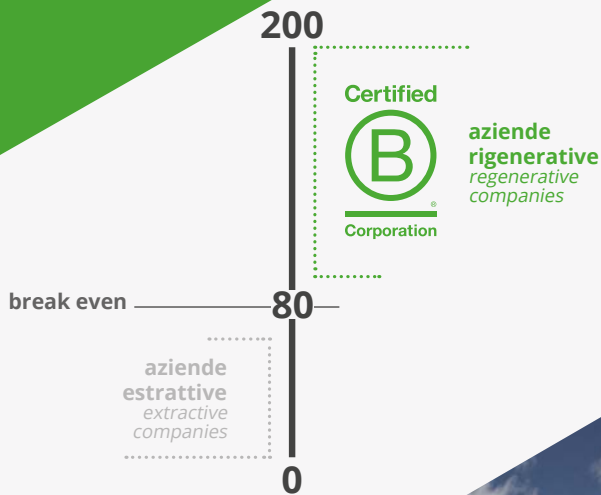

REGENERATIVE BUSINESS

An historical **cultural shift** is under way, of which we are proud to be a part. One of the underlying principles of all B Corps is the adoption of a regenerative business model as opposed to an extractive one.

Regenerating means not only reducing the impact of business on our surrounding nature and environment, but also producing **positive effects, creating shared value in society and regenerating the biosphere**.

Only those companies that measure their overall impact through the Benefit Impact Assessment (BIA) exceeding the score of 80 points can be certified as B Corp, joining an elite of **regenerative companies**. Anyone who does not exceed this threshold is considered an **extractive company** or, in order to function, they consume higher economic, social and environmental resources than they are able to generate as output.

IL PUNTEGGIO DI FLORIM

Il punteggio conseguito da Florim Italia è di 98,1 punti e il consolidato, che comprende la consociata americana, è di 90,9 punti. Così Florim rientra tra le migliori B Corp al mondo.

Solo il 3% delle aziende riesce a superare l'iter di verifica imposto da **B Lab**, ente certificatore di origine americana che oggi opera a livello globale.

FLORIM'S SCORE

Florim Italia score is 98.1 points and the consolidated, which includes the American subsidiary, is 90.9 points. Florim is now one of the best B Corps throughout the world.

Only 3% of companies manage to pass the verification process implemented by **B Lab**, the US certifying body that currently operates on a global scale.

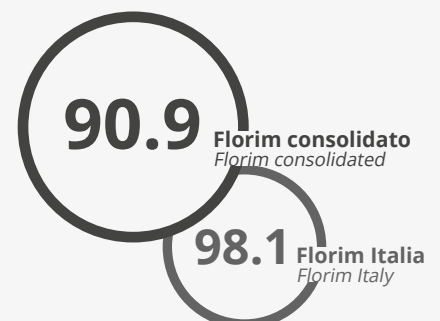

Azienda

Produciamo superfici ceramiche da oltre 60 anni con **passione, innovazione, impegno costante al miglioramento e responsabilità sociale** d'impresa. Sono queste le linee guida che contraddistinguono il nostro modo di fare impresa: il **MADE IN FLORIM**.

We produce porcelain stoneware surfaces with **passion, innovation and in a socially responsible way**. Those are the guidelines that identify our business and which can be summed up in a few words: **MADE IN FLORIM**.

Nous produisons des surfaces céramiques depuis plus de 60 ans avec **passion, innovation, recherche et une attention à la responsabilité sociale d'entreprise**. Ce sont les lignes phares qui guident notre mode de travailler: le **MADE IN FLORIM**.

Wir produzieren seit über 60 Jahren Keramikoberflächen mit **Leidenschaft, Innovationsgeist, ständigem Engagement für Verbesserungen und sozialer Unternehmensverantwortung**. Dies sind die Prinzipien, die unsere Arbeitsweise auszeichnen: kurz **MADE IN FLORIM**.

Producimos superficies cerámicas por más de 60 años con **pasión, innovación, compromiso de mejora constante y responsabilidad social**. Estos son los valores distintivos de nuestro modo de hacer empresa: el **MADE IN FLORIM**.



Creative design

Progetti completi rivolti all' interior in cui eleganza e creatività trovano un equilibrio perfetto. Il progetto si esprime attraverso un costante dialogo tra la ricerca di colore e contaminazioni materiche di ispirazione naturale.

Complete projects dedicated to interiors wherein elegance and creativity come together in perfect balance. The project manifests itself through constant dialogue between the quest for colour and material contaminations inspired by nature.

Des projets complets destinés à l'intérieur, pour un équilibre parfait entre élégance et créativité. Le projet s'exprime à travers un dialogue constant entre la recherche de couleur et la contamination entre les matières inspirée de la nature.

Komplette Projekte für den Innenraum, bei denen Eleganz und Kreativität ein perfektes Gleichgewicht erreichen. Das Projekt nimmt durch einen ständigen Dialog zwischen gelungener Farbwahl und von der Natur inspirierten Materialmixturen Gestalt an.

Proyectos completos para ambientes interiores, en los que la elegancia y la creatividad alcanzan un equilibrio perfecto. El proyecto se expresa a través de un constante diálogo entre la búsqueda del color y contaminaciones matéricas inspiradas en la naturaleza.

refinement



color

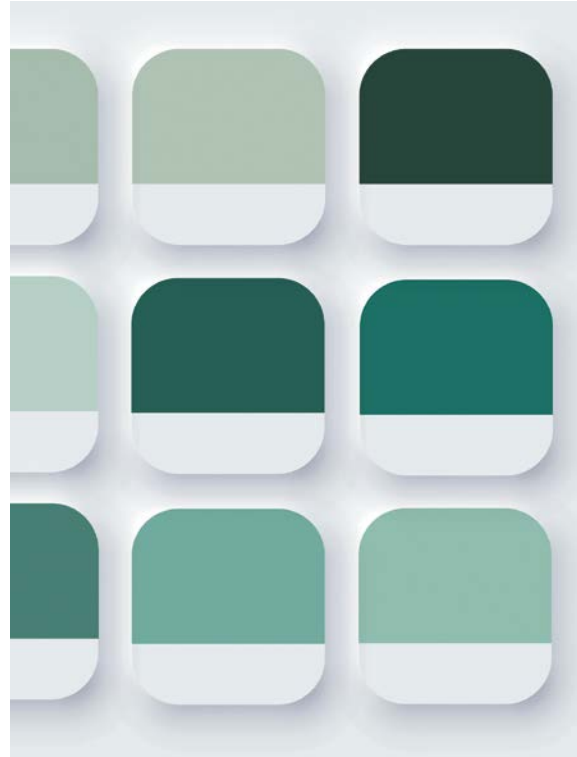

mood board



harmony

Indice



gres fine porcellanato

fine porcelain stoneware / grès cérame fin
feinsteinzeug-kollektionen / gres porcelánico fino

12/17		Icon outdoor
18/31		Nature mood
32/49		Neutra 6.0 (01/10)
50/65		Onyx&more
66/79		Pietre/3
80/99		S E N S I <i>Matteo Thun</i>
100/111		Stones&more 2.0
112/121		"Studios"
122/127		Urban style
134/141		Wooden tile

vetro

glass / verre / glas / vidrio

128/133 | Vetro

gres porcellanato decorato

decorated porcelain tiles
grès cérame décoré
verziertes feinsteinzeug
gres porcelánico decorado

32/49 | Neutra 6.0 (11/14)



La simbologia

SYMBOL/SYMBOLS/SYMBOL/SIMBOLOGIA

DIN 16165 ANNEX B: Scivolosità a piedi calzati: il materiale ceramico viene posto su un piano e oliato. Successivamente il piano viene progressivamente inclinato, mentre un operatore con scarpa di gomma cammina lungo il piano fino a quando non inizia a scivolare; la misura dell'angolo che si forma tra il piano inclinato e il suolo all'inizio dello scivolamento determina la classificazione del materiale. / Shod foot slipperiness: the ceramic material is placed on a surface and oiled. Subsequently, the surface is progressively tilted, while an operator with rubber shoes walks along the surface until he starts to slip; the measurement of the angle that is formed between the inclined surface and the ground when the slipping starts determines the classification of the material. / Glissance pieds chaussés : le matériau céramique est mis sur un plan et huilé. Le plan est ensuite incliné progressivement, tandis qu'un opérateur avec des chaussures en caoutchouc marche le long du plan jusqu'à ce qu'il ne commence à glisser ; la mesure de l'angle qui se forme entre le plan incliné et le sol au début du glissement donne la classification du matériau. / Rutsicherheit auf Schuhen: Das Keramikmaterial wird auf einer Fläche angebracht und mit einem Gleitmittel bestrichen. Daraufhin wird die Fläche nach und nach geneigt, während eine Prüfperson mit Gummischuhen die Fläche entlangläuft, bis sie ins Rutschen gerät. Die Größe des Winkels, der zwischen der geneigten Fläche und dem Boden zu Beginn der Rutschbewegung entsteht, bestimmt die Klassifizierung des Materials. / Deslizamiento con pies descalzos: el material cerámico se coloca sobre un plano y se aceita. Seguidamente el plano se inclina progresivamente, mientras que un operador con calzado de goma camina a lo largo del plano hasta que empieza a resbalar; la medida del ángulo que se forma entre la superficie inclinada y el suelo al principio del deslizamiento determina la clasificación del material.

DIN 16165 ANNEX A: Scivolosità a piedi nudi: il materiale ceramico viene posto su un piano e bagnato. Successivamente il piano viene progressivamente inclinato, mentre un operatore con piede nudo cammina lungo il piano fino a quando non inizia a scivolare; la misura dell'angolo che si forma tra il piano inclinato e il suolo all'inizio dello scivolamento determina la classificazione del materiale. / Barefoot slipperiness: the ceramic material is placed on a surface and made wet. Subsequently, the surface is progressively tilted, while an operator with bare feet walks along the surface until he starts to slip; the measurement of the angle that is formed between the inclined plane and the ground when slipping starts determines the classification of the material. / Glissance pieds nus : le matériau céramique est mis sur un plan et mouillé. Le plan est ensuite incliné progressivement, tandis qu'un opérateur pieds nus marche le long du plan jusqu'à ce qu'il ne commence à glisser ; la mesure de l'angle qui se forme entre le plan incliné et le sol au début du glissement donne la classification du matériau. / Rutsicherheit barfuß: Das Keramikmaterial wird auf einer Fläche angebracht und befeuchtet. Daraufhin wird die Fläche nach und nach geneigt, während eine Prüfperson barfuß die Fläche entlangläuft, bis sie ins Rutschen gerät. Die Größe des Winkels, der zwischen der geneigten Fläche und dem Boden zu Beginn der Rutschbewegung entsteht, bestimmt die Klassifizierung des Materials. / Deslizamiento con pies descalzos: el material cerámico se pone sobre un plano y se moja. Seguidamente el plano se inclina progresivamente, mientras que un operador con los pies descalzos camina a lo largo del plano hasta que empieza a resbalar; la medida del ángulo que se forma entre la superficie inclinada y el suelo al principio del deslizamiento determina la clasificación del material.

DCOF: Coefficiente di attrito dinamico: viene misurata la forza necessaria per mantenere in movimento un elemento (BOT 3000) rivestito in gomma dalla superficie della piastrella in condizioni di superficie bagnata; il rapporto tra la forza necessaria e il peso dell'elemento scivolante indica il Coefficiente di attrito dinamico. / Dynamic coefficient of friction: the force required to maintain the movement of an element (BOT 3000) coated with rubber on the surface of the tile in wet surface conditions is measured; the relationship between the force required and the weight of the slipping element indicates the dynamic coefficient of friction. / Coefficient de frottement dynamique : la force nécessaire pour maintenir en mouvement un élément (BOT 3000) revêtu en caoutchouc sur la surface du carreau en conditions de surface mouillée est mesurée ; la relation entre la force nécessaire et le poids de l'élément glissant indique le coefficient de frottement dynamique. / Dynamischer Reibungskoeffizient: Gemessen wird die Kraft, die erforderlich ist, um ein Element mit Gummiverkleidung (BOT 3000) durch die Fliese bei nasser Oberfläche in Bewegung zu halten. Das Verhältnis zwischen der erforderlichen Kraft und dem Gewicht des gleitenden Elements gibt den dynamischen Reibungskoeffizienten wieder. / Coeficiente de fricción cinética: se mide la fuerza necesaria para mantener en movimiento un elemento (BOT 3000) revestido de goma por la superficie de la baldosa bajo condiciones de superficie mojada; la relación entre la fuerza necesaria y el peso del elemento que resbala indica el Coeficiente de fricción dinámica.

SQUADRATO / SQUARED / EQUARRI / REKTIFIZIERT / ESCUADRADO

Piastrelle o lastre ceramiche portate a dimensioni predefinite, ognuno esattamente uguale all'altra (monocalibro) con sistema di mole abrasive. Ceramic tiles or slabs made to a pre-defined size, each one exactly the same as the others (single size), using a system of abrasive grinders. / Carreaux ou dalles céramiques mises aux dimensions prédéfinies, parfaitement identiques l'une à l'autre (mono-calibre) grâce à un système de disques abrasifs. / Fliesen oder Keramikplatten mit festgelegten Formaten. Alle Fliesen sind aufgrund der Verwendung des Schleifscheiben-Systems hundertprozentig identisch (Monokaliber). / Baldosas o piezas de cerámica que se realizan con dimensiones predefinidas, cada pieza es exactamente igual a la otra (mono dimensión) con sistema de discos abrasivos.

Grado di variazione cromatica

DEGREE OF COLOUR CHANGE/DEGRE DE VARIATION CHROMATIQUE/GRAD DER FARBABWEICHUNG/GRADO DE VARIACIÓN CROMÁTICA

 <p>LOW</p>	<p>v1 PRODOTTO MONOCROMATICO. The least amount of shade and texture variation. Attainable in naturally fired clay products. Produit monochromatique. Eifarbiges produkt. Producto monocromático.</p>
 <p>MODERATE</p>	<p>v2 PRODOTTO CON LEGGERA VARIAZIONE CROMATICA. Light to moderate shade and texture variation within each carton. Produit à légère variation chromatique. Produkt mit leichter farbnuance. Producto con una pequeña variación cromática.</p>
 <p>HIGH</p>	<p>v3 PRODOTTO CON MARCATA VARIAZIONE CROMATICA. High shade texture variation within each carton. Produit à variation chromatique accentuée. Produkt mit ausgeprägter farbnuance. Producto con evidente variación cromática.</p>
 <p>RANDOM</p>	<p>v4 PRODOTTO CON FORTE VARIAZIONE CROMATICA. Very high shade and texture variation within each carton. Produit à forte variation chromatique. Produkt mit starker farbnuance. Producto con fuerte variación cromática.</p>

Superfici

SURFACES/SURFACES/OBERFLÄCHEN/SUPERFICIES

Naturale / Matte / Mat / Matt / Mate

Superficie risultante dalla produzione di piastrella pressata senza lavorazioni successive alla cottura. / Surface coming from manufacturing pressed tiles without further work after firing. / Surface résultant de la production d'un carreau pressé sans être travaillé après la cuisson. / Die Oberfläche entsteht durch das Fliesenpressverfahren - im Anschluss an das Brennen erfolgt keine weitere Bearbeitung. / Superficie que resulta de la producción de baldosa prensada sin ulteriores elaboraciones después de la cocción.

Strutturato / Structured / Structuré / Strukturiert / Estructurado

Superficie risultante dalla produzione di piastrella pressata, a tampone non liscio con intensità di evidenza variabile (da leggera ondulazione ad imitazione di pietra tagliata), senza lavorazioni successive alla cottura. / Surface coming from manufacturing pressed tiles, using a rough pad with variable intensity (from a slightly undulating one to inspired cut stone), without processing after firing. / Surface résultant de la production d'un carreau pressé, par un tampon à relief avec une intensité d'aspect variable (de légère ondulation à l'inspiration de la pierre taillée), sans être travaillé après la cuisson. / Die Oberfläche beruht auf dem Produktionsverfahren der Fliesenpressung unter Verwendung eines unglatten Stempels mit Intensitätsvariation (leichte Wellung entsprechend eines geschnittenen Steins). Es erfolgt keine Weiterbearbeitung nach dem Brennen. / Superficie que resulta de la producción de baldosa prensada, con tampón no liso con intensidad de evidencia variable (de ligera ondulación a imitación de piedra cortada), sin ulteriores elaboraciones después de la cocción.

Bocciardato / Bush-hammered / Bouchardé / Gehämmert / Abujardado

Superficie risultante dalla produzione di piastrella sottoposta, dopo la pressatura ma prima della cottura, a lavorazione meccanica consistente nell'asportazione irregolare di uno strato di materia per ottenere una superficie come per la pietra assolutamente naturale (antiscivolo), con leggere differenze non ripetibili tra una piastrella ed un'altra. / Surface coming from manufacturing tiles subjected to mechanical processing consisting of irregularly removing a layer of material after pressing but before firing in order to obtain a surface like absolutely pure natural stone (non slip), with slight unrepeatable differences between one tile and another. / Surface résultant de la production d'un carreau soumis, après le pressage mais avant la cuisson, à un travail mécanique qui consiste à éliminer de façon irrégulière une épaisseur de matière afin d'obtenir une surface semblable à la pierre naturelle tout à fait naturelle (anti-glisser), avec de légères différences variant d'un carreau à l'autre. / Zur Gewinnung dieser Oberfläche wurde die Fliese im Anschluss an die Pressung und vor dem Brennen einer mechanischen Bearbeitung zur Abtragung von Unregelmäßigkeiten einer Materialschicht unterzogen. Mit Hilfe dieses Verfahrens wird eine absolut natürliche und dem Naturstein entsprechende (rutschfeste) Oberfläche erzielt, die für geringfügige, aber einmalige Unterschiede unter den Fliesen verantwortlich ist. / Superficie que resulta de la producción de baldosa sometida, después del prensado pero antes de la cocción, a un proceso mecánico consistente en la eliminación irregular de una capa de materia para obtener una superficie como la piedra totalmente natural (resistente al deslizamiento), con ligeras diferencias que no se repiten entre una baldosa y otra.

Glossy

Superficie ottenuta dopo la cottura sottoponendo le lastre a spazzolatura e lucidatura meccanica con serie di utensili abrasivi a grana decrescente. La superficie finale è morbida, lucida e riflettente. / Surface obtained after firing subjecting the slabs to mechanical brushing and polishing with a series of decreasing grain abrasive utensils. The final surface is soft, glossy and reflective. / Surface obtenue après cuisson, en soumettant les dalles à un brossage et un polissage mécanique avec un jeu d'outils abrasifs de grain décroissant. La surface finale est douce, brillante et réfléchissante. / Oberfläche, die nach dem Brand erhalten wurde, indem Platten mit einer Serie von Reibwerkzeugen mit kleiner werdender Struktur einer mechanischen Bürstung und Politur unterzogen wurde. Die fertige Oberfläche ist weich, glänzend und reflektierend. / Superficie obtenida después de la cocción sometiendo las losas a un procedimiento de cepillado y pulido mecánico con una serie de utensilios abrasivos de grano decreciente. La superficie final es suave, brillante y reflectante.

Superficie R+PTV / R+PTV Surface / Surface R+PTV / Oberfläche R+PTV / Superficie R+PTV

Superficie ottenuta dalla produzione di piastrella con tampone opportunamente sagomato così da raggiungere precise caratteristiche di sicurezza misurate secondo i principali metodi normativi in uso. La superficie finale è leggermente ruvida, opaca e conforme ai requisiti di scivolosità R10 (norma di riferimento DIN EN 16165 ANNEX B) e scivolosità Pendolo >36 wet (slider 96, norma di riferimento BS EN 16165 ANNEX C -AS/NZS 4586). Surface obtained from the production of tiles with appropriately shaped die in order to achieve precise safety characteristics measured based on the main prevailing regulatory methods in use. The final surface is slightly rough, matt and complies with R10 slipperiness requirements (reference standard DIN EN 16165 ANNEX B) and Pendulum slipperiness >36 wet (slider 96, reference standard BS EN 16165 ANNEX C -AS/NZS 4586). / Surface obtenue à partir de la production de carreaux avec tampon opportunément façonné de manière à satisfaire des caractéristiques de sécurité précises, mesurées suivant les principales méthodes réglementaires en vigueur. La surface finale est légèrement rugueuse, mate et répond aux exigences de la classe de glissance R10 (norme de référence DIN EN 16165 ANNEX B) et de glissance - test du pendule - humide - valeur >36 (slider 96, norme de référence BS EN 16165 ANNEX C -AS/NZS 4586). / Durch die Produktion von Fliesen mit entsprechend geformter Kachelunterlage erhaltene Oberfläche, um präzise Sicherheits-Charakteristiken zu erzielen, gemessen nach den wichtigsten angewandten Regelungsmethoden. Die fertige Oberfläche ist leicht angeraut, matt und konform mit den rutschhemmenden Eigenschaft R10 (Bezugsnorm DIN EN 16165 ANNEX B) und der Rutschfestigkeit Pendolo >36 wet (slider 96, Bezugsnorm BS EN 16165 ANNEX C -AS/NZS 4586). / Superficie obtenida de la producción de baldosas con un molde específicamente fabricado para alcanzar características precisas de seguridad de conformidad con los principales métodos normativos vigentes. La superficie final es ligeramente áspera, opaca y conforme a los requisitos de resistencia al deslizamiento R10 (norma de referencia DIN EN 16165 ANNEX B) y resistencia al deslizamiento Péndulo >36 mojado (slider 96, norma de referencia BS EN 16165 ANNEX C -AS/NZS 4586).

Smooth / Satin

Superficie ottenuta dopo la cottura sottoponendo a spazzolatura meccanica di intensità intermedia lastre non smaltate con tampone liscio o ondulato. La superficie finale è morbida, lievemente satinata, non riflettente. / Surface obtained after firing subjecting unglazed slabs to intermediate intensity mechanical brushing with smooth or wavy die. The final surface is soft, slightly satin-finished, non reflective. Surface obtenue après cuisson, en soumettant des dalles non émaillées à un brossage mécanique de moyenne intensité au moyen d'un tampon lisse ou ondulé. La surface finale est douce, légèrement satinée, non réfléchissante. / Oberfläche, die nach dem Brand erhalten wurde, indem nicht emailierte Platten mit glatter oder wellförmiger Kachelunterlage mit einer Serie von Reibwerkzeugen mit kleiner werdender Struktur einer mechanischen Bürstung mit mittlerer Stärke unterzogen wurden. Die fertige Oberfläche ist weich, leicht satiniert, nicht reflektierend. / Superficie obtenida después de la cocción sometiendo las losas no esmaltadas a un procedimiento de cepillado mecánico de intensidad intermedia con molde liso u ondulado. La superficie final es suave, ligeramente satinada, no reflectante.

Comfort

La nuova superficie Comfort è frutto dello storico know-how industriale della nostra azienda e rappresenta una vera e propria rivoluzione nell'utilizzo del prodotto ceramico. Comfort unisce il tatto morbido e piacevole delle finiture naturali con prestazioni tecniche sulla scivolosità (R10 classe B e PTV>36) che la rendono particolarmente indicata nelle applicazioni pubbliche e commerciali, anche in condizioni di umidità e bagnato. / The new Comfort surface is the outcome of our company's historic industrial know-how and represents a real revolution in the use of ceramic products. Comfort combines the soft, pleasant feel of a matte surface with anti-slip technical performances (R10 class B and PTV >36) that make it particularly suitable for public and commercial applications, including in wet and humid conditions. / La nouvelle surface Comfort est l'aboutissement de l'historique savoir-faire industriel de notre entreprise. Elle révolutionne littéralement l'emploi du produit céramique. Comfort allie le toucher doux et agréable des finitions naturelles aux performances techniques sur la glissance (R10 classe B et PTV >36). La surface est ainsi tout particulièrement indiquée dans les applications publiques et commerciales, y compris dans les lieux humides et mouillés. / Die neue Oberfläche Comfort basiert auf dem langjährigen produktionstechnischen Know-how unseres Unternehmens und steht für eine echte Revolution in der Verwendung keramischer Produkte. Comfort vereint die angenehm weiche Haptik einer natürlichen Oberfläche mit technischen Eigenschaften in punkto Rutschhemmung (R10 Klasse B und PTV>36), die das Produkt für den Einsatz in öffentlichen und gewerblichen Bereichen, und zwar auch bei Feuchtigkeit und Nässe, prädestinieren. La nueva superficie Comfort es fruto del histórico saber hacer industrial de nuestra empresa y representa una auténtica revolución en el uso del producto cerámico. Comfort aún el tacto suave y agradable del acabado natural con unas prestaciones técnicas de resistencia al deslizamiento (R10 clase B y PTV>36) que la convierten en particularmente indicada para aplicaciones públicas y comerciales, incluso en condiciones de humedad y de mojado.

Tabella Imballi

PACKAGE TABLE - TABLEAU DE EMBALLAGES - TABELLE FORMATE - TABLA DE LOS EMBALAJES

	scatola - box			pallet		
	pz	mq	kg	box	mq	kg

imballi per scatola
packages for boxes
emballages pour boîte
verpackungen für schachteln
embalajes para cajas

imballi per pallet
packages for pallets
emballages pour palette
verpackungen für paletts
embalajes para paletas

Tabella gruppi di prezzo

TABLE OF PRICE RANGES - TABLEAU GROUPE DES PRIX - TABELLE PREISGRUPPEN - TABLA DE GRUPO DE PRECIOS

Descrizione simboli / Description of symbols / Description symboles / Zeichenerklärung / Descripción de los símbolos			
■	▲	●	◆
PREZZO PER MATERIALE GESTITO A METRO QUADRO Price for materials managed per square metre. Prix pour matériau géré au mètre carré Materialpreis pro quadratmeter Precio del material por metro cuadrado	*PREZZO PER MATERIALE GESTITO A PEZZO Price for materials managed per piece Prix pour matériau géré à la pièce Materialpreis pro stück Precio del material por pieza	PREZZO PER MATERIALE GESTITO A NUMERO/COMPOSIZIONE Price for materials managed per number/composition Prix pour matériau géré à nombre/composition Materialpreis pro anzahl/zusammenstellung Precio del material por número/composición	PREZZO PER MATERIALE GESTITO A METRO LINEARE Price for materials managed lm Prix pour matériau géré à mètre linéaire Materialpreis pro lfm Precio del material por ml
*costo al pezzo, vendita a scatola completa price per piece, sold by full boxes only • prix à la pièce, vente à la boîte complète • stückpreis bei voller kartonabnahme • precio à la pieza, venta à caja completata			



ICON OUTDOOR

gres fine porcellanato
fine porcelain stoneware
grès cérame fin
feinsteinzeug-kollektionen
gres porcelánico fino





ICON OUTDOOR

Icon outdoor è la nuova soluzione in gres porcellanato autoportante al servizio delle applicazioni outdoor private e pubbliche che permette di coniugare design, prestazioni, versatilità, facilità di posa e sostenibilità ambientale. Composto da materiali riciclati per una percentuale superiore al 70%, icon outdoor è certificato dall'ente Bureau Veritas in accordo con lo standard internazionale ISO 14021. Nei due formati 60x60 e 40x120 icon outdoor è una soluzione di design resistente, durevole e di facile manutenzione. Nel pieno rispetto delle politiche di eco sostenibilità perseguite da Florim negli ultimi anni, la realizzazione di icon outdoor (come quella di tutti i prodotti Florim) non comporta scarichi di acque nell'ambiente esterno, ma grazie ad un processo di depurazione esse vengono reimpiegate nel processo produttivo.

Icon outdoor is the new self-supporting porcelain tile solution for outdoor applications in both private and public spaces, enabling design, performance, versatility, easy laying and environmental sustainability to be combined. Comprising over 70% of recycled materials, Icon Outdoor is certified by Bureau Veritas in accordance with the international ISO 14021 standard. In the two sizes 60x60 cm and 40x120 cm Icon Outdoor is a tough, long-lasting and easy-maintenance design solution. Icon Outdoor complies fully with the eco-sustainability policies that Florim has been pursuing in recent years, and is created (as are all Florim products) by not discharging water into the external environment but, through a purification system, by re-using it in the production process.

Icon Outdoor est une nouvelle solution autoporteuse en grès cérame au service des applications extérieures publiques et privées, alliant design, performances, polyvalence, facilité de pose et durabilité environnementale. Composée de matériaux recyclés à plus de 70 %, Icon Outdoor est certifiée par Bureau Veritas, conformément à la norme internationale ISO 14021. Les deux formats 60x60 et 40x120 font d'Icon Outdoor une solution design résistante, durable et d'entretien facile. Dans le respect absolu des politiques en matière d'éco-durabilité mises en place par Florim lors des dernières années, la fabrication d'Icon Outdoor (à l'instar de tous les produits Florim) n'entraîne pas de rejets d'eaux dans l'environnement. Grâce à un système d'épuration, celles-ci sont en effet réintroduites dans le processus de production.

Icon outdoor ist die neue Lösung aus selbsttragendem Steinzeug für Anwendungen im privaten und öffentlichen Outdoor-Bereich. Sie vereint Design, Leistung, Vielseitigkeit, einfache Verlegbarkeit und Umweltverträglichkeit. Icon outdoor besteht zu mehr als 70% aus recycelten Materialien und ist von Bureau Veritas nach dem internationalen Standard ISO 14021 zertifiziert. In den beiden Formaten 60x60 und 40x120 stellt Icon outdoor eine widerstandsfähige, dauerhafte und wartungsarme Designlösung dar. Im Einvernehmen mit der in den letzten Jahren von Florim verfolgten Unternehmenspolitik der ökologischen Nachhaltigkeit gelangen bei der Herstellung von Icon outdoor (ebenso wie bei allen anderen Florim Produkten) die Abwasser nicht in die Kanalisation, sondern werden dank eines Wasserreinigungssystems in den Produktionsprozess zurückgeführt.

Icon outdoor es la nueva solución de gres porcelánico autoportante para ambientes exteriores, privados o públicos, que permite combinar diseño, prestaciones, versatilidad, facilidad de colocación y sostenibilidad ambiental. Compuesto por materiales reciclados en un porcentaje superior al 70 %, **Icon outdoor** está certificado por el ente Bureau Veritas con el estándar internacional ISO 14021. En sus dos formatos —60 x 60 y 40 x 120— Icon outdoor es una solución de diseño resistente, duradera y de fácil mantenimiento. En estricto cumplimiento de las políticas de sostenibilidad ambiental adoptadas por Florim en los últimos años, la realización de Icon outdoor (como la de todos los productos Florim) no comporta la descarga de aguas en el ambiente exterior; por el contrario, gracias a un proceso de depuración, son reutilizadas en el proceso productivo.

ICON OUTDOOR

Vantaggi tecnici - Technical advantages - Avantages techniques Technische Vorteile - Ventajas técnicas

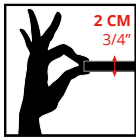

- Lastra monolitica compatta di spessore 2 cm quadrata e rettificata
- Compact monolithic slab 2 cm thick squared and rectified
- Dalle monolithique compacte de 2 cm d'épaisseur, équerrie et rectifiée
- Kompakte monolithische Platte, 2 cm dick, rechteckig und scharfkantig geschliffen
- Losa monolítica compacta de 2 cm de espesor, escuadrada y rectificada.

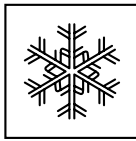

- INGELIVO
- FROST RESISTANT
- INGÉLIF
- FROSTBESTÄNDIG
- RESISTENTE A LA HELADA

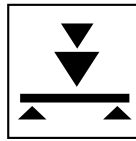

- ELEVATA RESISTENZA AI CARICHI STATICI
- HIGH STATIC LOAD RESISTANCE
- RÉSISTANCE ÉLEVÉE AUX CHARGES STATIQUES
- HOHE STATISCHE BELASTBARKEIT
- ELEVADA RESISTENCIA A LAS CARGAS ESTÁTICAS

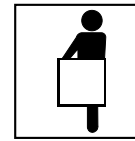

- FACILE DA POSARE
- EASY TO INSTALL
- FACILE À POSER
- VERLEGELEICHT
- FÁCIL DE COLOCAR



- ANTISCIVOLO R11
- ANTI SLIP R11
- ANTIDÉRAPANT R11
- RUTSCHFEST R11
- ANTIDESLIZANTE R11

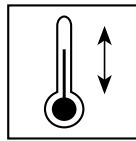

- RESISTENTE AGLI SBALZI TERMICI
- THERMAL SHOCK RESISTANT
- RÉSISTANT AUX ÉCARTS THERMIQUES
- TEMPERATURWECHSELBESTÄNDIG
- RESISTENTE A LAS OSCILACIONES TÉRMICAS



- FACILE DA PULIRE
- EASY TO CLEAN
- FACILE À NETTOYER
- REINIGUNGSLEICHT
- FÁCIL DE LIMPIAR

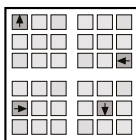

- RIMOVIBILE E RIUTILIZZABILE
- REMOVABLE AND REUSABLE
- DÉMONTABLE ET RÉUTILISABLE
- ENTFERNBAR UND WIEDERVERWENDBAR
- DESMONTABLE Y REUTILIZABLE



- INATTACCABILE DA AGENTI CHIMICI E MUFFE
- IMPERVIOUS TO ATTACK BY CHEMICALS OR MOULD
- RÉSISTANT AUX AGENTS CHIMIQUES ET AUX MOISSISSURES
- UNANGREIFBAR DURCH CHEMISCHE STOFFE UND SCHIMMEL
- RESISTENTE A LOS AGENTES QUÍMICOS Y A LOS MOHOS

Applicazioni - Applications - Applications - Verlegung - Aplicaciones

- Posa diretta su erba
- Direct installation on grass
- Pose direct sur de l'herbe
- Verlegung direkt auf Rasen
- Colocación directa sobre hierba



- Posa diretta su ghiaia
- Direct installation over gravel
- Pose direct sur du gravier
- Verlegung direkt auf Kies
- Colocación directa sobre grava



- Posa su massetto cementizio
- Installation on sand-cement screed
- Pose sur chape ciment
- Verlegung auf Zement-Unterbetonblock
- Colocación sobre contrapiso de hormigón

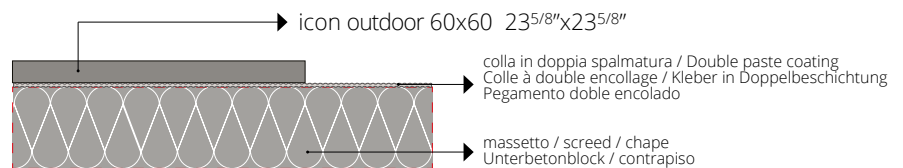

- Posa su piedini fissi o regolabili
- Installation on fixed or adjustable feet
- Pose sur pieds fixes ou réglables
- Verlegung auf feststehende oder regulierbare Füße
- Colocación sobre pies fijos o regulables

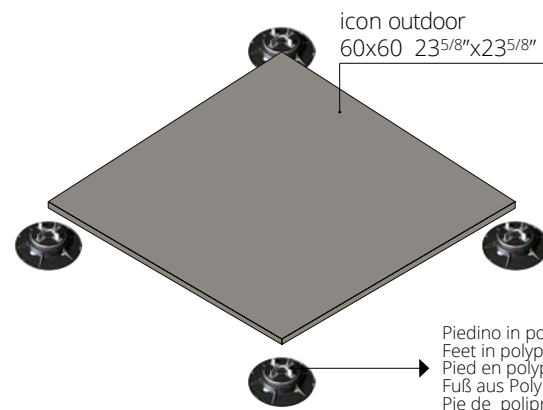

Per le specifiche di utilizzo dei sistemi sopraelevati vedi il sito florim.com
For the specifics on use of raised systems visit the site florim.com
Pour les caractéristiques d'utilisation des systèmes surélevés, voir le site florim.com
Für die Nutzungsbedingungen der Doppelbodensysteme siehe Webseite florim.com
Para las especificaciones de empleo de los sistemas sobreelevados consulte el sitio web florim.com

Le lastre ceramiche sono sottoposte a un trattamento di compattazione termica che assicura resistenza e durata nel tempo. Il bassissimo assorbimento d'acqua rende perciò il materiale ingelivo. Ciò può comportare ristagni d'acqua superficiali anche per materiale installato a regola d'arte. / Ceramic tiles undergo a compacting thermal treatment that ensures resistance and durability. The low level of water absorption makes the slabs frost resistant. This could result in superficial water stagnations even if materials are installed in a workmanlike manner. / Les carreaux de céramique subissent un traitement thermique de compactage qui assure résistance et durabilité. Le bas niveau d'absorption d'eau rend les dalles résistant au gel. Il pourrait en résulter des stagnations d'eau superficielles, même si les dalles ont été installées dans les règles de l'art. / Die Keramikplatten werden einer thermischen Verdichtung unterzogen, welche die Widerstandsfähigkeit und Langlebigkeit sichert. Die extrem niedrige Wasseraufnahme macht das Material frostsicher. Die hohe Materialdichte kann, auch bei einer perfekten Verlegung, eine längere Abtrochnungszeit von angestaumtem Wasser zur Folge haben. / Las baldosas cerámicas se someten a un tratamiento de compactación térmica que asegura resistencia y durabilidad. La baja absorción de agua hace que las baldosas resistan al hielo. Esto podría resultar en estancamientos superficiales de agua, incluso si los materiales están instalados según las reglas del arte.

WHITE



LIGHT GRAY



**R11
CLASSE C**

DCOF >
0,42 Wet

20 mm 3/4" ↑ ↓

GRES FINE PORCELLANATO

FINE PORCELAIN STONEWARE/GRES CERAME FIN/FEINSTEINZEUG-KOLLEKTIONEN/GRES PORCELANICO FINO
SQUADRATO - SQUARED - EQUARRI - REKTIFIZIERT - ESCUADRADO

20 mm 3/4" ↑ ↓	COLOR	SURFACE	40x120	60x60
			15 ^{3/4} "x47 ^{1/4} "	23 ^{5/8} "x23 ^{5/8} "
ICON OUTDOOR  	WHITE	GRIP	740407 ■ FL-10800	740401 ■ FL-07700
	LIGHT GRAY	GRIP	740406 ■ FL-10800	740400 ■ FL-07700

Product Certification
BUREAU VERITAS
Certification



Recycled material content certification

	RESISTENZA ALLA FLESSIONE IN N/mm² <small>N/mm² FLEXURAL STRENGTH TEST / RESISTANCE A LA FLEXION EN N/mm² / BIEGEFESTIGKEIT IN N/mm² / RESISTENCIA A LA FLEXION EN N/mm² / УСТОЙЧИВОСТЬ К ИЗГИБУ В Н/мм²</small>	valore medio 52 N/mm²
	Forza di rottura in N (sp. > 7,5 mm) <small>Breaking strength in N (sp. > 7,5 mm) / Force de rupture en N (esp. > 7,5 mm) / Bruchlast in N (Dicke > 7,5 mm) / Fuerza de rotura en N (gr. > 7,5 mm) / Разрушающее усилие, Н (толщ. > 7,5 мм)</small>	valore medio 14000 N

PEZZI SPECIALI
Special trims/Pièces spéciales
Formstücke/Piezas especiales
pag 144/147

ICON OUTDOOR	scatola - box			pallet		
	pz	mq	kg	box	mq	kg
40x120 20mm	2	0,96	42,86	24	23,04	1060
60x60 20mm	2	0,72	32,15	30	21,60	990



NATURE MOOD

gres fine porcellanato
fine porcelain stoneware
grès cérame fin
feinsteinzeug-kollektionen
gres porcelánico fino





NATURE MOOD

Natura come primo valore assoluto, non come risorsa da dominare e sfruttare. Natura come casa, come nido accogliente, come perfetta sintesi di ciò che ci fa stare bene. Con la collezione **Nature mood** l'ambiente naturale "invade" gli spazi costruiti dall'uomo, entra nelle nostre case divenendo parte del modo di sentire e di vivere gli ambienti per influenzare positivamente il nostro umore. Pavimenti e rivestimenti di pareti e arredi diventano uno sfondo emozionale che si intreccia in un armonioso dialogo di sfumature e venature, consentendoci di ritrovare quell'equilibrio psico-fisico dal quale la crescente urbanizzazione e la tecnologia ci fanno spesso allontanare. In linea con le più recenti tendenze dell'housing evolution Nature mood concepisce la Natura non solo come modello, ma come vero e proprio mentore e misura del progetto umano, dalla quale apprendere e con la quale dare vita a un design sempre più sostenibile.

Nature seen not as a resource to be dominated and exploited, but as the first absolute value. Nature as a home, as a cosy nest, as the perfect synthesis of what makes us feel good. With the **Nature Mood** collection, the natural environment "invades" man-made spaces, enters our homes and becomes part of the way we sense and experience our surroundings, influencing our mood in a positive way. Floors, wall coverings and furniture become an emotional backdrop interwoven in a harmonious dialogue of nuances and veining, making it possible for us to rediscover that psycho-physical balance from which increasing urbanization and technology often distance us. In line with the latest trends in housing evolution, Nature Mood conceives of Nature not only as a model, but also as a true mentor and gauge of human endeavor, something from which to acquire knowledge and with which to give life to increasingly environmentally friendly designs.

Redémarrer, donner vie à un nouveau parcours, prendre un nouveau départ. Recommencer par la Nature. La Nature comme première valeur absolue, non pas comme une ressource à dominer et à exploiter. La Nature comme une maison, un nid accueillant, la synthèse parfaite de ce qui nous fait nous sentir bien. Avec la collection **Nature mood**, l'environnement naturel « envahit » les espaces construits par l'homme, entre dans nos maisons et s'intègre dans notre manière de ressentir et de vivre les espaces pour influencer de façon positive notre humeur. Les revêtements de sol, les revêtements muraux et les meubles deviennent une toile de fond émotionnelle qui s'entremêle dans un dialogue harmonieux de nuances et de veines, nous permettant de retrouver l'équilibre psychophysique qui se dissipe souvent en raison de l'urbanisation croissante et de la technologie. En ligne avec les tendances les plus récentes de l'housing evolution, Nature mood conçoit la Nature non seulement comme un modèle mais comme un véritable mentor et une dimension du projet humain, source de connaissances et grâce à laquelle donner vie à un design de plus en plus durable.

Neu starten, einen neuen Weg einschlagen, einen Neuanfang. Von der Natur ausgehend neu beginnen. Natur als erster absoluter Wert, nicht als zu beherrschende und auszubeutende Ressource. Die Natur als Zuhause, als einladendes Nest, als perfekte Synthese dessen, was uns gut tut. Mit der Kollektion **Nature Mood** „dringt“ die natürliche Umgebung in die von Menschenhand geschaffenen Räume „ein“, kommt in unsere Wohnungen und wird Teil der Art und Weise, wie wir unsere Umgebung fühlen und erleben, um unsere Stimmung positiv zu beeinflussen. Böden, Wandverkleidungen und Einrichtungsgegenstände werden zu einem emotionalen, in einem harmonischen Dialog zwischen Farbtönen und Adern verwobenen Hintergrund und ermöglichen es uns, jenes psycho-physische Gleichgewicht wiederzufinden, von dem uns die zunehmende Urbanisierung und die Technologie oft entfernen. Im Einklang mit den neuesten Trends in der Evolution des Wohnens versteht Nature Mood die Natur nicht nur als Vorbild, sondern als echten Mentor und Maßstab für die menschliche Gestaltung, von der wir lernen und mit der wir ein immer nachhaltigeres Design ins Leben rufen können.

Volver a empezar, comenzar un nuevo curso, un nuevo inicio. Volver a empezar desde la Naturaleza. Naturaleza como primer valor absoluto, no como recurso para dominar y explotar. Naturaleza como hogar, como nido acogedor, como perfecta síntesis de lo que nos hace sentir bien. Con la colección **Nature mood**, el ambiente natural "invade" los espacios construidos por las personas, entra en nuestras casas, convirtiéndose en parte de la manera de sentir y de vivir los ambientes para influir positivamente en nuestras emociones. Los pavimentos y los revestimientos de paredes y decoraciones se convierten en un fondo emocional que se entrelaza en un armonioso diálogo de matices y vetas, permitiéndonos encontrar ese equilibrio psicofísico del que a menudo nos alejan la creciente urbanización y la tecnología. En línea con las últimas tendencias de la evolución de la vivienda, Nature mood concibe la Naturaleza no solo como modelo, sino como verdadero mentor y medida del proyecto humano, para comprender y dar vida a un diseño cada vez más sostenible.

NATURE MOOD

GLACIER



TUNDRA



R10
CLASSE B
(comfort)

DCOF>
0,42 Wet
(comfort)

BS EN 16165
ANNEX C
>36 Wet
slider 4S
(comfort)

9 mm 3/8" ↑↓



R10
CLASSE B
(comfort)

DCOF>
0,42 Wet
(comfort)

BS EN 16165
ANNEX C
>36 Wet
slider 4S
(comfort)

6 mm 1/4" ↑↓

FLORM OVERSIZE
magnUm

GRES FINE PORCELLANATO

FINE PORCELAIN STONEWARE/GRES CERAME FIN/FEINSTEINZEUG-KOLLEKTIONEN/GRES PORCELANICO FINO
SQUADRATO - SQUARED - EQUARRI - REKTIFIZIERT - ESCUADRADO

9 mm 3/8" ↑↓		COLOR	SURFACE	80x180 31 1/2" x 70 6/7"	60x120 23 5/8" x 47 1/4"		
NATURE MOOD	GLACIER	GLOSSY		774674 ■ FL-11900	775102 ■ FL-11300		
		COMFORT		774669 ■ FL-10500	775097 ■ FL-09900		
	TUNDRA	GLOSSY		774676 ■ FL-11900	775104 ■ FL-11300		
		COMFORT		774671 ■ FL-10500	775099 ■ FL-11300		
6 mm 1/4" ↑↓		COLOR	SURFACE	120x280 47 1/4" x 110 1/4"	120x240 47 1/4" x 94 1/2"	120x120 47 1/4" x 47 1/4"	60x120 23 5/8" x 47 1/4"
NATURE MOOD	GLACIER	GLOSSY		774718 ■ FL-15100	774871 ■ FL-14000	774887 ■ FL-12400	774903 ■ FL-11300
		COMFORT		774706 ■ FL-12400	774860 ■ FL-11300	774876 ■ FL-09700	774892 ■ FL-09100
	TUNDRA	GLOSSY		774720 ■ FL-15100	774873 ■ FL-14000	774889 ■ FL-12400	774905 ■ FL-11300
		COMFORT		774708 ■ FL-12400	774862 ■ FL-11300	774878 ■ FL-09700	774894 ■ FL-09100

RAINFOREST



MOUNTAIN PEAK



R10
CLASSE B
(comfort)

DCOF>
0,42 Wet
(comfort)

BS EN 16165
ANNEX C
>36 Wet
slider 4S
(comfort)

9 mm 3/8" ↑↓



R10
CLASSE B
(comfort)





DCOF>
0,42 Wet
(comfort)

BS EN 16165
ANNEX C
>36 Wet
slider 4S
(comfort)

6 mm 1/4" ↑↓

FLOORM OVERSIZE
magnum

GRES FINE PORCELLANATO
FINE PORCELAIN STONEWARE/GRES CERAME FIN/FEINSTEINZEUG-KOLLEKTIONEN/GRES PORCELANICO FINO
SQUADRATO - SQUARED - EQUARRI - REKTIFIZIERT - ESCUADRADO

		9 mm 3/8" ↑↓		80x180 31 1/2" x 70 5/7"		60x120 23 5/8" x 47 1/4"					
		COLOR	SURFACE								
NATURE MOOD		RAINFOREST	GLOSSY	774673 ■ FL-11900	775101 ■ FL-11300						
			COMFORT	774646 ■ FL-10500	775096 ■ FL-09900						
		MOUNTAIN PEAK	GLOSSY	774675 ■ FL-11900	775103 ■ FL-11300						
			COMFORT	774670 ■ FL-10500	775098 ■ FL-09900						
		6 mm 1/4" ↑↓		120x280 47 1/4" x 110 1/4"		120x240 47 1/4" x 94 1/2"		120x120 47 1/4" x 47 1/4"		60x120 23 5/8" x 47 1/4"	
		COLOR	SURFACE								
NATURE MOOD		RAINFOREST	GLOSSY	774717 ■ FL-15100	774870 ■ FL-14000	774886 ■ FL-12400	774902 ■ FL-11300				
			COMFORT	774705 ■ FL-12400	774859 ■ FL-11300	774875 ■ FL-09700	774891 ■ FL-09100				
		MOUNTAIN PEAK	GLOSSY	774719 ■ FL-15100	774872 ■ FL-14000	774888 ■ FL-12400	774904 ■ FL-11300				
			COMFORT	774707 ■ FL-12400	774861 ■ FL-11300	774877 ■ FL-09700	774893 ■ FL-09100				

NATURE MOOD

RIVERBED



R10
CLASSE B
(comfort)

DCOF >
0,42 Wet
(comfort)

BS EN 16165
ANNEX C
>36 Wet
slider 4S
(comfort)

9 mm 3/8" ↑↓



R10
CLASSE B
(comfort)

DCOF >
0,42 Wet
(comfort)

BS EN 16165
ANNEX C
>36 Wet
slider 4S
(comfort)

6 mm 1/4" ↑↓

FLORM OVERSIZE
magnUm

GRES FINE PORCELLANATO

FINE PORCELAIN STONEWARE/GRES CERAME FIN/FEINSTEINZEUG-KOLLEKTIONEN/GRES PORCELANICO FINO
SQUADRATO - SQUARED - EQUARRI - REKTIFIZIERT - ESCUADRADO

9 mm 3/8" ↑↓		COLOR	SURFACE	80x180 31 1/2" x 70 6/7"	60x120 23 5/8" x 47 1/4"		
NATURE MOOD		RIVERBED	GLOSSY	774677 ■ FL-11900	775105 ■ FL-11300		
			COMFORT	774672 ■ FL-10500	775100 ■ FL-09900		
6 mm 1/4" ↑↓		COLOR	SURFACE	120x280 47 1/4" x 110 1/4"	120x240 47 1/4" x 94 1/2"	120x120 47 1/4" x 47 1/4"	60x120 23 5/8" x 47 1/4"
NATURE MOOD		RIVERBED	GLOSSY	774721 ■ FL-15100	774874 ■ FL-14000	774890 ■ FL-12400	774906 ■ FL-11300
			COMFORT	774709 ■ FL-12400	774863 ■ FL-11300	774879 ■ FL-09700	774895 ■ FL-09100

PLANK_01

PLANK_02

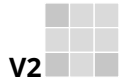

V2
R10
CLASSE B
 (comfort)

R11
CLASSE C
 (strutturato)

DCOF>
 0,42 Wet
 (comfort)

BS EN 16165
 ANNEX C
 >36 Wet
 slider 4S
 (comfort)

9 mm 3/8" ↑↓

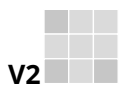

V2
R10
CLASSE B
 (comfort)

DCOF>
 0,42 Wet
 (comfort)





BS EN 16165
 ANNEX C
 >36 Wet
 slider 4S
 (comfort)

6 mm 1/4" ↑↓



GRES FINE PORCELLANATO

FINE PORCELAIN STONEWARE/GRES CERAME FIN/FEINSTEINZEUG-KOLLEKTIONEN/GRES PORCELANICO FINO
 SQUADRATO - SQUARED - EQUARRI - REKTIFIZIERT - ESCUADRADO

			9 mm 3/8" ↑↓				
		COLOR	SURFACE	26,5x180 10 ^{3/7"} x70 ^{5/7"}	20x180 7 ^{7/8"} x70 ^{5/7"}	30x120 11 ^{4/5"} x47 ^{1/4"}	
NATURE MOOD	PLANK_01		COMFORT	774679 ■ FL-09900	774685 ■ FL-09900	-	
			STRUTTURATO/STRUCTURED	-	-	775139 ■ FL-09300	
	PLANK_02		COMFORT	774680 ■ FL-09900	774687 ■ FL-09900	-	
			STRUTTURATO/STRUCTURED	-	-	775140 ■ FL-09300	
			6 mm 1/4" ↑↓				
		COLOR	SURFACE	120x280 47 ^{1/4"} x110 ^{1/4"}	120x240 47 ^{1/4"} x94 ^{1/2"}	120x120 47 ^{1/4"} x47 ^{1/4"}	60x120 23 ^{5/8"} x47 ^{1/4"}
NATURE MOOD	PLANK_01		COMFORT	774711 ■ FL-12400	774864 ■ FL-11300	774880 ■ FL-09700	774896 ■ FL-09100
	PLANK_02		COMFORT	774712 ■ FL-12400	774865 ■ FL-11300	774881 ■ FL-09700	774897 ■ FL-09100

NATURE MOOD

PLANK_03



PLANK_04

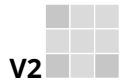

V2
R10
CLASSE B
 (comfort)

R11
CLASSE C
 (strutturato)

DCOF>
 0,42 Wet
 (comfort)

BS EN 16165
 ANNEX C
 >36 Wet
 slider 4S
 (comfort)

9 mm 3/8" ↑↓

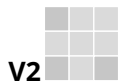

V2
R10
CLASSE B
 (comfort)

DCOF>
 0,42 Wet
 (comfort)

BS EN 16165
 ANNEX C
 >36 Wet
 slider 4S
 (comfort)

6 mm 1/4" ↑↓

FLORIM OVERSIZE
magnUm

GRES FINE PORCELLANATO
 FINE PORCELAIN STONEWARE/GRES CERAME FIN/FEINSTEINZEUG-KOLLEKTIONEN/GRES PORCELANICO FINO
 SQUADRATO - SQUARED - EQUARRI - REKTIFIZIERT - ESCUADRADO

9 mm 3/8" ↑↓	COLOR	SURFACE	26,5x180 10 ^{3/7"} x70 ^{6/7"}	20x180 7 ^{7/8"} x70 ^{6/7"}	30x120 11 ^{4/5"} x47 ^{1/4"}
	PLANK_03	COMFORT	774681 ■ FL-09900	774688 ■ FL-09900	-
NATURE MOOD		COMFORT	774682 ■ FL-09900	774689 ■ FL-09900	-
		STRUTTURATO/STRUCTURED	-	-	775141 ■ FL-09300

6 mm 1/4" ↑↓	COLOR	SURFACE	120x280 47 ^{1/4"} x110 ^{1/4"}	120x240 47 ^{1/4"} x94 ^{1/2"}	120x120 47 ^{1/4"} x47 ^{1/4"}	60x120 23 ^{5/8"} x47 ^{1/4"}
	PLANK_03	COMFORT	774713 ■ FL-12400	774866 ■ FL-11300	774882 ■ FL-09700	774898 ■ FL-09100
NATURE MOOD		COMFORT	774714 ■ FL-12400	774867 ■ FL-11300	774883 ■ FL-09700	774899 ■ FL-09100

PLANK_05

PLANK_06

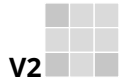

R10
CLASSE B
(comfort)

R11
CLASSE C
(strutturato)

DCOF>
0,42 Wet
(comfort)

BS EN 16165
ANNEX C
>36 Wet
slider 4S
(comfort)

9 mm 3/8" ↑↓

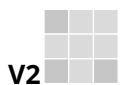

R10
CLASSE B
(comfort)

DCOF>
0,42 Wet
(comfort)

BS EN 16165
ANNEX C
>36 Wet
slider 4S
(comfort)

6 mm 1/4" ↑↓







GRES FINE PORCELLANATO
FINE PORCELAIN STONEWARE/GRES CERAME FIN/FEINSTEINZEUG-KOLLEKTIONEN/GRES PORCELANICO FINO
SQUADRATO - SQUARED - EQUARRI - REKTIFIZIERT - ESCUADRADO





9 mm 3/8" ↑↓		COLOR	SURFACE	26,5x180 10 ^{3/7"} x70 ^{6/7"}	20x180 7 ^{7/8"} x70 ^{6/7"}	30x120 11 ^{4/5"} x47 ^{1/4"}
NATURE MOOD		PLANK_05	COMFORT	774683 ■ FL-09900	774690 ■ FL-09900	-
			STRUTTURATO/STRUCTURED	-	-	775142 ■ FL-09300
		PLANK_06	COMFORT	774684 ■ FL-09900	774691 ■ FL-09900	-

6 mm 1/4" ↑↓		COLOR	SURFACE	120x280 47 ^{1/4"} x110 ^{1/4"}	120x240 47 ^{1/4"} x94 ^{1/2"}	120x120 47 ^{1/4"} x47 ^{1/4"}	60x120 23 ^{5/8"} x47 ^{1/4"}
NATURE MOOD		PLANK_05	COMFORT	774715 ■ FL-12400	774868 ■ FL-11300	774884 ■ FL-09700	774900 ■ FL-09100
		PLANK_06	COMFORT	774716 ■ FL-12400	774869 ■ FL-11300	774885 ■ FL-09700	774901 ■ FL-09100

NATURE MOOD

PEZZI SPECIALI/SPECIAL TRIMS/PIÈCES SPÉCIALES/FORMSTÜCKE/PIEZAS ESPECIALES

9 mm 3/8" ↑↓		COLOR	SURFACE	4,6x60 1 4/5" x 2 3/8"	33x120x3 1 3/4" x 4 7/8" x 1 1/8"
				battiscopa	gradino pz/box 2
NATURE MOOD		GLACIER	GLOSSY	775513 ◆ FL-01600	775503 ▲ FL-02260
			COMFORT	775518 ◆ FL-01600	775508 ▲ FL-20400
		TUNDRA	GLOSSY	775514 ◆ FL-01600	775504 ▲ FL-02260
			COMFORT	775519 ◆ FL-01600	775509 ▲ FL-20400
		RAINFOREST	GLOSSY	775515 ◆ FL-01600	775505 ▲ FL-02260
			COMFORT	775520 ◆ FL-01600	775510 ▲ FL-20400
		MOUNTAIN PEAK	GLOSSY	775516 ◆ FL-01600	775506 ▲ FL-02260
			COMFORT	775521 ◆ FL-01600	775511 ▲ FL-20400
		RIVERBED	GLOSSY	775517 ◆ FL-01600	775507 ▲ FL-02260
			COMFORT	775522 ◆ FL-01600	775512 ▲ FL-20400









6 mm 1/4" ↑↓		COLOR	SURFACE	4,6x60 1 4/5" x 2 3/8"
				battiscopa
NATURE MOOD		GLACIER	GLOSSY	775487 ◆ FL-01800
			COMFORT	775492 ◆ FL-01800
		TUNDRA	GLOSSY	775488 ◆ FL-01800
			COMFORT	775493 ◆ FL-01800
		RAINFOREST	GLOSSY	775489 ◆ FL-01800
			COMFORT	775494 ◆ FL-01800
		MOUNTAIN PEAK	GLOSSY	775490 ◆ FL-01800
			COMFORT	775495 ◆ FL-01800
		RIVERBED	GLOSSY	775491 ◆ FL-01800
			COMFORT	775496 ◆ FL-01800



Per un effetto ottimale della posa, florim suggerisce di mantenere 2 mm di fuga per pose monofornate e 3 mm per combinare formati misti - For optimal installation results, florim recommends maintaining a joint of 2 mm 1/16" for single format installations and 3 mm 1/8" to combine mixed formats. - Pour réaliser une pose parfaite, florim suggère de maintenir 2 mm de joint pour la pose des monofornats, et 3 mm pour les combinaisons de formats mixtes. - Um einen optimalen Effekt beim Verlegen zu erzielen empfiehlt florim eine 2 mm fugen bei einformatigen Verlegungen und 3 mm fugen bei formatkombinationen Para lograr los máximos resultados en la posa del producto, florim aconseja 2 mm de junta en aplicaciones monofornate y 3 mm en combinaciones de formatos mixtos.

In relazione alle differenti tecnologie produttive l'accostamento di prodotti con spessori diversi potrebbe presentare delle disomogeneità, se ne sconsiglia pertanto l'abbinamento. / Due to the different production technologies, contiguous installation of products with different thickness may give a non-homogeneous result. For this reason we do not recommend this option. / Vu que différentes technologies de production sont utilisées avec des épaisseurs différentes, des problèmes d'homogénéité pourraient se présenter, il est donc déconseillé de les poser ensemble. / Wegen unterschiedlicher Produktionstechnologien können die Fliesen mit verschiedenen Materialstärken optische Differenzen aufweisen. Von einem direkten Aneinanderlegen wird deshalb abgeraten. / Dadas las diferentes tecnologías productivas, la combinación de productos de diferentes espesores podría dar lugar a heterogeneidad, por lo que se desaconseja mezclarlas.

6 mm 1/4" ↑↓

	COLOR	SURFACE	10x53 4"x20" ^{6/7"}  chevron sx	10x53 4"x20" ^{6/7"}  chevron dx	4x120 1 ^{4/7"} x47 ^{1/4"}  strip
	PLANK_01	COMFORT	775380 ■ FL-14900	775374 ■ FL-14900	775387 ■ FL-19800
	PLANK_02	COMFORT	775381 ■ FL-14900	775375 ■ FL-14900	775388 ■ FL-19800
	PLANK_03	COMFORT	775382 ■ FL-14900	775376 ■ FL-14900	775389 ■ FL-19800
NATURE MOOD					
	PLANK_04	COMFORT	775383 ■ FL-14900	775377 ■ FL-14900	775390 ■ FL-19800
	PLANK_05	COMFORT	775384 ■ FL-14900	775378 ■ FL-14900	775391 ■ FL-19800
	PLANK_06	COMFORT	775386 ■ FL-14900	775379 ■ FL-14900	775392 ■ FL-19800

FLORM OVERSIZE
magnUm

120x280/120x240/120x120/60x120

Specifica Imballo pag.
Packaging specifications on page
Spécifications d'emballage à page
Verpackungsdetail Seite
Especificaciones de embalaje a la página
154/155

NATURE MOOD	scatola - box			pallet		
	pz	mq	kg	box	mq	kg
80x180	2	2,88	57,60	20	57,60	1210
60x120	2	1,44	27,73	30	43,20	860
26,5x180	3	1,44	28,80	42	60,48	1270
20x180	4	1,44	28,80	40	57,60	1210
30x120	3	1,08	21,49	24	25,92	550

NATURE MOOD	scatola - box			pallet		
	pz	ml	kg	box	mq	kg
4,6x60 battiscopa	14	8,40	8,40	-	-	-

NATURE MOOD

6 mm 1/4" 

COLOR	SURFACE	60x60 23 ^{5/8"} x23 ^{5/8"} hexagon mix pz/box 6
-------	---------	--



MIX 1
(Plank 06+Plank 05+Plank 04)

COMFORT

775398
▲ FL-08200

NATURE MOOD



MIX 2
(Plank 03+Plank 02+Plank 01)

COMFORT

775399
▲ FL-08200

6 mm 1/4" 

COLOR	SURFACE	40x40 15 ^{3/4"} x15 ^{3/4"} stripes mix pz/box 11
-------	---------	---



MIX 1
(Plank 06+Plank 05)

COMFORT

775394
▲ FL-04700

NATURE MOOD



MIX 2
(Plank 01+Plank 02)

COMFORT

775395
▲ FL-04700

6 mm 1/4" 

COLOR	SURFACE	32,5x45,6 12 ^{4/5"} x18" french herringbone mix pz/box 9
-------	---------	---



MIX 1
(Plank 05+Plank 06)

COMFORT

775396
▲ FL-03700

NATURE MOOD



















MIX 2
(Plank 01+Plank 02)

COMFORT

775397
▲ FL-03700

PEZZI SPECIALI/SPECIAL TRIMS/PIÈCES SPÉCIALES/FORMSTÜCKE/PIEZAS ESPECIALES

9 mm 3/8" 		COLOR	SURFACE	4,6x60 1 4/5" x 23 5/8"  battiscopa
NATURE MOOD		PLANK_01	COMFORT	775523 ◆ FL-01600
		PLANK_02	COMFORT	775524 ◆ FL-01600
		PLANK_03	COMFORT	775525 ◆ FL-01600
		PLANK_04	COMFORT	775526 ◆ FL-01600
		PLANK_05	COMFORT	775527 ◆ FL-01600
		PLANK_06	COMFORT	775528 ◆ FL-01600

6 mm 1/4" 		COLOR	SURFACE	4,6x60 1 4/5" x 23 5/8"  battiscopa
NATURE MOOD		PLANK_01	COMFORT	775497 ◆ FL-01800
		PLANK_02	COMFORT	775498 ◆ FL-01800
		PLANK_03	COMFORT	775499 ◆ FL-01800
		PLANK_04	COMFORT	775500 ◆ FL-01800
		PLANK_05	COMFORT	775501 ◆ FL-01800
		PLANK_06	COMFORT	775502 ◆ FL-01800



NEUTRA 6.0

gres fine porcellanato
fine porcelain stoneware
grès cérame fin
feinsteinzeug-kollektionen
gres porcelánico fino

gres porcellanato decorato
decorated porcelain tiles
grès cérame décoré
verziertes feinsteinzeug
gres porcelánico decorado





NEUTRA 6.0

Una nuova versione della serie che ha segnato l'origine del marchio Creative design. Nuovi spessori, formati e colori andranno a caratterizzare un prodotto innovativo e contemporaneo.

For a new version of the series that has marked the origin of the Creative design. New thicknesses, sizes and colours will feature in an innovative and contemporary product.

Une nouvelle version de la série qui a marqué l'origine de la marque Creative design. De nouvelles épaisseurs, des formats et des couleurs pour caractériser un produit innovant et contemporain.

Eine neue Version der Serie, die den Ursprung des Markenzeichens Creative design kennzeichnete. Neue Stärken, Formate und Farben charakterisieren ein innovatives und modernes Produkt.

Una nueva versión de la serie que ha marcado el origen de la marca Creative design. Nuevos espesores, formatos y colores caracterizan a un producto contemporáneo e innovador.

NEUTRA 6.0

01 BIANCO

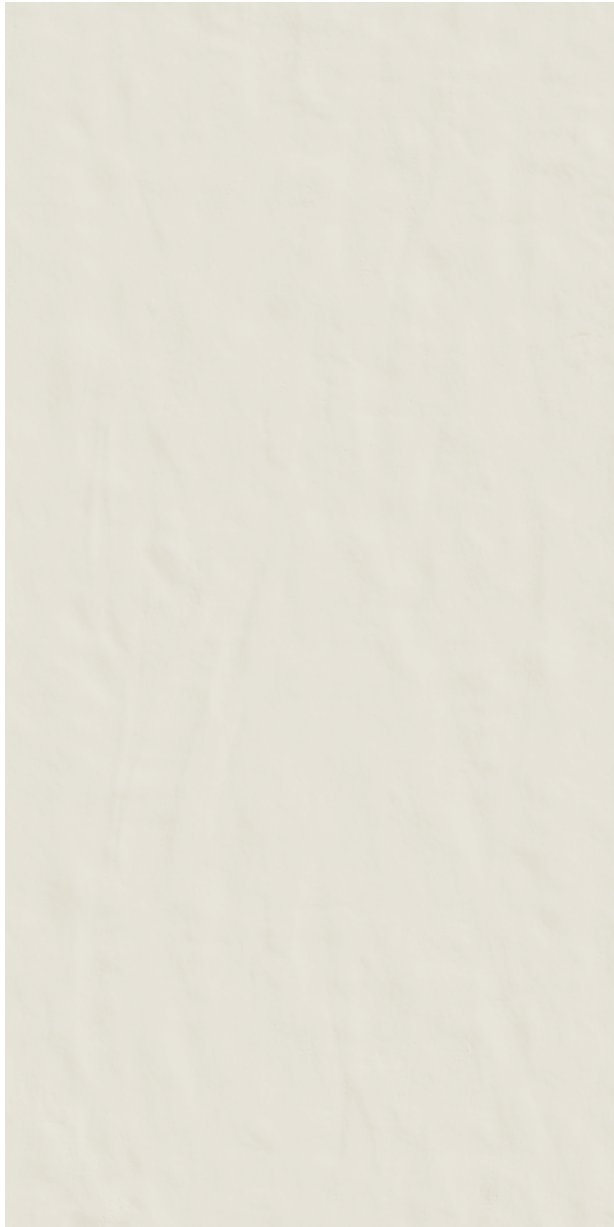

02 POLVERE

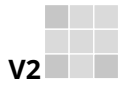

9 mm 3/8" ↑↓

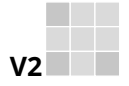

DCOF>
0,42 Wet

6 mm 1/4" ↑↓

FLOORM OVERSIZE
magnUm

GRES FINE PORCELLANATO
FINE PORCELAIN STONWARE/GRES CERAME FIN/FEINSTEINZEUG-KOLLEKTIONEN/GRES PORCELANICO FINO
SQUADRATO - SQUARED - EQUARRI - REKTIFIZIERT - ESCUADRADO

9 mm 3/8" ↑↓		COLOR	SURFACE	60x120 23 ^{5/8"} x47 ^{1/4"}	80x80 31 ^{1/2"} x31 ^{1/2"}	
NEUTRA 6.0		01 BIANCO	MATTE	734749 ■ FL-09300	734677 ■ FL-08600	
		02 POLVERE	MATTE	754016 ■ FL-09300	754005 ■ FL-08600	
6 mm 1/4" ↑↓		COLOR	SURFACE	120x240 47 ^{1/4"} x94 ^{1/2"}	120x120 47 ^{1/4"} x47 ^{1/4"}	60x120 23 ^{5/8"} x47 ^{1/4"}
NEUTRA 6.0		01 BIANCO	MATTE	748487 ■ FL-11300	748493 ■ FL-09700	749161 ■ FL-09100
		02 POLVERE	MATTE	748488 ■ FL-11300	748494 ■ FL-09700	749162 ■ FL-09100

03 PERLA

04 FERRO

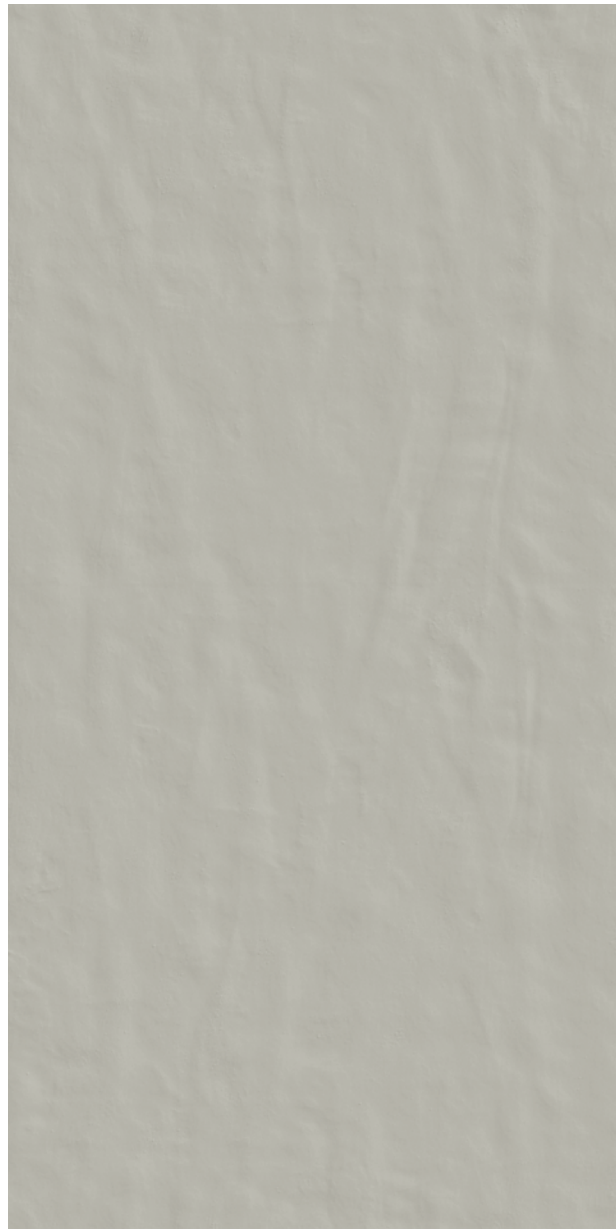

V2 

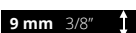
9 mm 3/8" 



V2 



DCOF>
0,42 Wet

6 mm 1/4" 

FLOORM OVERSIZE
magnUm

GRES FINE PORCELLANATO
FINE PORCELAIN STONWARE/GRES CERAME FIN/FEINSTEINZEUG-KOLLEKTIONEN/GRES PORCELANICO FINO
SQUADRATO - SQUARED - EQUARRI - REKTIFIZIERT - ESCUADRADO

9 mm 3/8" 		COLOR	SURFACE	60x120 23 ^{3/8"} x47 ^{1/4"}	80x80 31 ^{1/2"} x31 ^{1/2"}
NEUTRA 6.0		03 PERLA	MATTE	754017 ■ FL-09300	754006 ■ FL-08600
		04 FERRO	MATTE	754018 ■ FL-09300	754007 ■ FL-08600

6 mm 1/4" 		COLOR	SURFACE	120x240 47 ^{1/4"} x94 ^{1/2"}	120x120 47 ^{1/4"} x47 ^{1/4"}	60x120 23 ^{5/8"} x47 ^{1/4"}
NEUTRA 6.0		03 PERLA	MATTE	748489 ■ FL-11300	748495 ■ FL-09700	749163 ■ FL-09100
		04 FERRO	MATTE	748490 ■ FL-11300	748496 ■ FL-09700	749164 ■ FL-09100

NEUTRA 6.0

05 QUARZO



06 GRAFITE

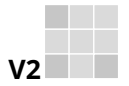

9 mm 3/8" ↑↓

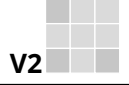

DCOF>
0,42 Wet

6 mm 1/4" ↑↓

FLOHM OVERSIZE
magnUm

GRES FINE PORCELLANATO
FINE PORCELAIN STONEWARE/GRES CERAME FIN/FEINSTEINZEUG-KOLLEKTIONEN/GRES PORCELANICO FINO
SQUADRATO - SQUARED - EQUARRI - REKTIFIZIERT - ESCUADRADO

9 mm 3/8" ↑↓		COLOR	SURFACE	60x120 23 ^{5/8"} x47 ^{1/4"}	80x80 31 ^{1/2"} x31 ^{1/2"}
NEUTRA 6.0		05 QUARZO	MATTE	754019 ■ FL-09300	754008 ■ FL-08600
		06 GRAFITE	MATTE	754020 ■ FL-09300	754009 ■ FL-08600

6 mm 1/4" ↑↓		COLOR	SURFACE	120x240 47 ^{1/4"} x94 ^{1/2"}	120x120 47 ^{1/4"} x47 ^{1/4"}	60x120 23 ^{5/8"} x47 ^{1/4"}
NEUTRA 6.0		05 QUARZO	MATTE	748491 ■ FL-11300	748497 ■ FL-09700	749165 ■ FL-09100
		06 GRAFITE	MATTE	748492 ■ FL-11300	748498 ■ FL-09700	749166 ■ FL-09100

07 PETROLIO

08 AVIO



V2 

9 mm 3/8" 



V2 



DCOF>
0,42 Wet

6 mm 1/4" 

FLOORM OVERSIZE
magnUm

GRES FINE PORCELLANATO
FINE PORCELAIN STONWARE/GRES CERAME FIN/FEINSTEINZEUG-KOLLEKTIONEN/GRES PORCELANICO FINO
SQUADRATO - SQUARED - EQUARRI - REKTIFIZIERT - ESCUADRADO

9 mm 3/8" 		COLOR	SURFACE	60x120 23 ^{3/8"} x47 ^{1/4"}	80x80 31 ^{1/2"} x31 ^{1/2"}
NEUTRA 6.0		07 PETROLIO	MATTE	758125 ■ FL-09300	758119 ■ FL-08600
		08 AVIO	MATTE	758124 ■ FL-09300	758118 ■ FL-08600

6 mm 1/4" 		COLOR	SURFACE	120x240 47 ^{1/4"} x94 ^{1/2"}	120x120 47 ^{1/4"} x47 ^{1/4"}	60x120 23 ^{5/8"} x47 ^{1/4"}
NEUTRA 6.0		07 PETROLIO	MATTE	749556 ■ FL-11300	752890 ■ FL-09700	752892 ■ FL-09100
		08 AVIO	MATTE	749557 ■ FL-11300	752891 ■ FL-09700	752893 ■ FL-09100

NEUTRA 6.0

09 OLIVA



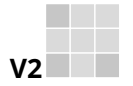

10 ACQUAMARINA



6 mm 1/4" ↑
 FLORM OVERSIZE
 magnum













GRES FINE PORCELLANATO
 FINE PORCELAIN STONWARE/GRES CERAME FIN/FEINSTEINZEUG-KOLLEKTIONEN/GRES PORCELANICO FINO
 SQUADRATO - SQUARED - EQUARRI - REKTIFIZIERT - ESCUADRADO

6 mm 1/4" ↑		COLOR	SURFACE	120x240 47 ^{1/4"} x94 ^{1/2"}	120x120 47 ^{1/4"} x47 ^{1/4"}	60x120 23 ^{5/8"} x47 ^{1/4"}
NEUTRA 6.0		09 OLIVA	MATTE	749558 ■ FL-11300	778168 ■ FL-09700	778170 ■ FL-09100
		10 ACQUAMARINA	MATTE	749559 ■ FL-11300	778169 ■ FL-09700	778171 ■ FL-09100

GRES FINE PORCELLANATO

FINE PORCELAIN STONEWARE/GRES CERAME FIN/FEINSTEINZEUG-KOLLEKTIONEN/GRES PORCELANICO FINO
SQUADRATO - SQUARED - EQUARRI - REKTIFIZIERT - ESQUADRADO

6 mm 1/4" ↓↑

	COLOR	SURFACE	30x30 11 4/5" x 11 4/5"  mosaico A tessere 3x3 pz/box 11	30x26 11 4/5" x 10 1/4"  mosaico B esagono 10x10 pz/box 11	30x30 11 4/5" x 11 4/5"  mosaico C esagono 7,5x15 pz/box 11	30x30 11 4/5" x 11 4/5"  mosaico D 10x15 pz/box 11	30x30 11 4/5" x 11 4/5"  mosaico E 10x15 pz/box 11	30x35 11 4/5" x 13 7/9"  mosaico F 10x15 pz/box 11
	01 BIANCO	MATTE	749574 ▲ FL-01900	749580 ▲ FL-04400	749586 ▲ FL-04900	749592 ▲ FL-04900	749598 ▲ FL-04900	749604 ▲ FL-05100
	02 POLVERE	MATTE	749575 ▲ FL-01900	749581 ▲ FL-04400	749587 ▲ FL-04900	749593 ▲ FL-04900	749599 ▲ FL-04900	749605 ▲ FL-05100
	03 PERLA	MATTE	749576 ▲ FL-01900	749582 ▲ FL-04400	749588 ▲ FL-04900	749594 ▲ FL-04900	749600 ▲ FL-04900	749606 ▲ FL-05100
	04 FERRO	MATTE	749577 ▲ FL-01900	749583 ▲ FL-04400	749589 ▲ FL-04900	749595 ▲ FL-04900	749601 ▲ FL-04900	749607 ▲ FL-05100
	05 QUARZO	MATTE	749578 ▲ FL-01900	749584 ▲ FL-04400	749590 ▲ FL-04900	749596 ▲ FL-04900	749602 ▲ FL-04900	749608 ▲ FL-05100
	06 GRAFITE	MATTE	749579 ▲ FL-01900	749585 ▲ FL-04400	749591 ▲ FL-04900	749597 ▲ FL-04900	749603 ▲ FL-04900	749609 ▲ FL-05100









VETRO

GLASS / VERRE / GLAS / VIDRIO

4,5 mm 1/8" ↓↑

MOSAICO











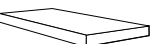

montato su pellicola trasparente
mounted on transparent film
monté sur film transparent
auf transparenter Folie montiert
montado en una película transparente











	COLOR	SURFACE	30x30 11 4/5" x 11 4/5"  mosaico A tessere 1,8x1,8 pz/box 11	29,2x28,3 11 1/2" x 11 1/7"  mosaico C esagono 1,6x3,2 pz/box 11	31x25 12 1/5" x 9 5/6"  mosaico E tessere 1,8x3,6 pz/box 11
	01 BIANCO	VETRO LUX	749610 ▲ FL-03300	749622 ▲ FL-03300	749634 ▲ FL-03300
	02 POLVERE	VETRO LUX	749611 ▲ FL-03300	749623 ▲ FL-03300	749635 ▲ FL-03300
	03 PERLA	VETRO LUX	749612 ▲ FL-03300	749624 ▲ FL-03300	749636 ▲ FL-03300
	04 FERRO	VETRO LUX	749613 ▲ FL-03300	749625 ▲ FL-03300	749637 ▲ FL-03300
	05 QUARZO	VETRO LUX	749614 ▲ FL-03300	749626 ▲ FL-03300	749638 ▲ FL-03300
	06 GRAFITE	VETRO LUX	749615 ▲ FL-03300	749627 ▲ FL-03300	749639 ▲ FL-03300

Per un effetto ottimale della posa, florim suggerisce di mantenere 2 mm di fuga per pose monoformato e 3 mm per combinare formati misti - For optimal installation results, florim recommends maintaining a joint of 2 mm 1/12" for single format installations and 3 mm 1/8" to combine mixed formats. - Pour réaliser une pose parfaite, florim suggère de maintenir 2 mm de joint pour la pose des monoformats, et 3 mm pour les combinaisons de formats mixtes. - Um einen optimalen Effekt beim Verlegen zu erzielen empfiehlt florim eine 2 mm Fuge bei einformatigen Verlegungen und 3 mm Fuge bei Formatkombinationen. Para lograr los máximos resultados en la posa del producto, florim aconseja 2 mm de junta en aplicaciones monoformato y 3 mm en combinaciones de formatos mixtos.

In relazione alle differenti tecnologie produttive l'accostamento di prodotti con spessori diversi potrebbe presentare delle disomogeneità, se ne sconsiglia pertanto l'abbinamento. / Due to the different production technologies, contiguous installation of products with different thickness may give a non-homogeneous result. For this reason we do not recommend this option. / Vu que différentes technologies de production sont utilisées avec des épaisseurs différentes, des problèmes d'homogénéité pourraient se présenter, il est donc déconseillé de les poser ensemble. / Wegen unterschiedlicher Produktionstechnologien können die Fliesen mit verschiedenen Materialstärken optische Differenzen aufweisen. Von einem direkten Aneinanderlegen wird deshalb abgeraten. / Dadas las diferentes tecnologías productivas, la combinación de productos de diferentes espesores podría dar lugar a heterogeneidad, por lo que se desaconseja mezclarlas.

PEZZI SPECIALI/SPECIAL TRIMS/PIÈCES SPÉCIALES/FORMSTÜCKE/PIEZAS ESPECIALES

9 mm 3/8" ↑↓		COLOR	SURFACE	4,6x80 1 4/5" x 3 1/2"  battiscopa	33x120x3 13" x 47 1/4" x 1 1/8"  gradino pz/box 2	33x120x3 13" x 47 1/4" x 1 1/8"  angolo gradino DX pz/box 2	33x120x3 13" x 47 1/4" x 1 1/8"  angolo gradino SX pz/box 2
NEUTRA 6.0		01 BIANCO	MATTE	754026 ◆ FL-01600	754033 ▲ FL-20400	754039 ▲ FL-31100	754045 ▲ FL-31100
		02 POLVERE	MATTE	754027 ◆ FL-01600	754034 ▲ FL-20400	754040 ▲ FL-31100	754046 ▲ FL-31100
		03 PERLA	MATTE	754028 ◆ FL-01600	754035 ▲ FL-20400	754041 ▲ FL-31100	754047 ▲ FL-31100
		04 FERRO	MATTE	754029 ◆ FL-01600	754036 ▲ FL-20400	754042 ▲ FL-31100	754048 ▲ FL-31100
		05 QUARZO	MATTE	754030 ◆ FL-01600	754037 ▲ FL-20400	754043 ▲ FL-31100	754049 ▲ FL-31100
		06 GRAFITE	MATTE	754031 ◆ FL-01600	754038 ▲ FL-20400	754044 ▲ FL-31100	754050 ▲ FL-31100
		07 PETROLIO	MATTE	758129 ◆ FL-01600	758131 ▲ FL-20400	758133 ▲ FL-31100	758135 ▲ FL-31100
		08 AVIO	MATTE	758128 ◆ FL-01600	758130 ▲ FL-20400	758132 ▲ FL-31100	758134 ▲ FL-31100

6 mm 1/4" ↑↓		COLOR	SURFACE	4,6x60 1 4/5" x 2 3/8"  battiscopa
NEUTRA 6.0		01 BIANCO	MATTE	759000 ◆ FL-01800
		02 POLVERE	MATTE	759001 ◆ FL-01800
		03 PERLA	MATTE	759002 ◆ FL-01800
		04 FERRO	MATTE	759003 ◆ FL-01800
		05 QUARZO	MATTE	759004 ◆ FL-01800
		06 GRAFITE	MATTE	759005 ◆ FL-01800
		07 PETROLIO	MATTE	759006 ◆ FL-01800
		08 AVIO	MATTE	759007 ◆ FL-01800
		09 OLIVA	MATTE	778172 ◆ FL-01800
		10 ACQUAMARINA	MATTE	778173 ◆ FL-01800

FLORIM OVERSIZE
magnUm

120x240/120x120/60x120
Specifica Imballo pag.
Packaging specifications on page
Spécifications d'emballage à page
Verpackungsdetail Seite
Especificaciones de embalaje a la página
154/155

NEUTRA 6.0	scatola - box			pallet		
	pz	mq	kg	box	mq	kg
60x120	2	1,44	28,08	30	43,20	870
80x80	2	1,28	24,96	40	51,20	1030

NEUTRA 6.0	scatola - box			pallet		
	pz	ml	kg	box	mq	kg
4,6x80 battiscopa	12	9,60	9,60	-	-	-

11 MELANZANA



12 MALVA

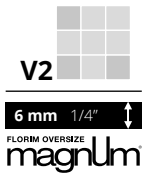
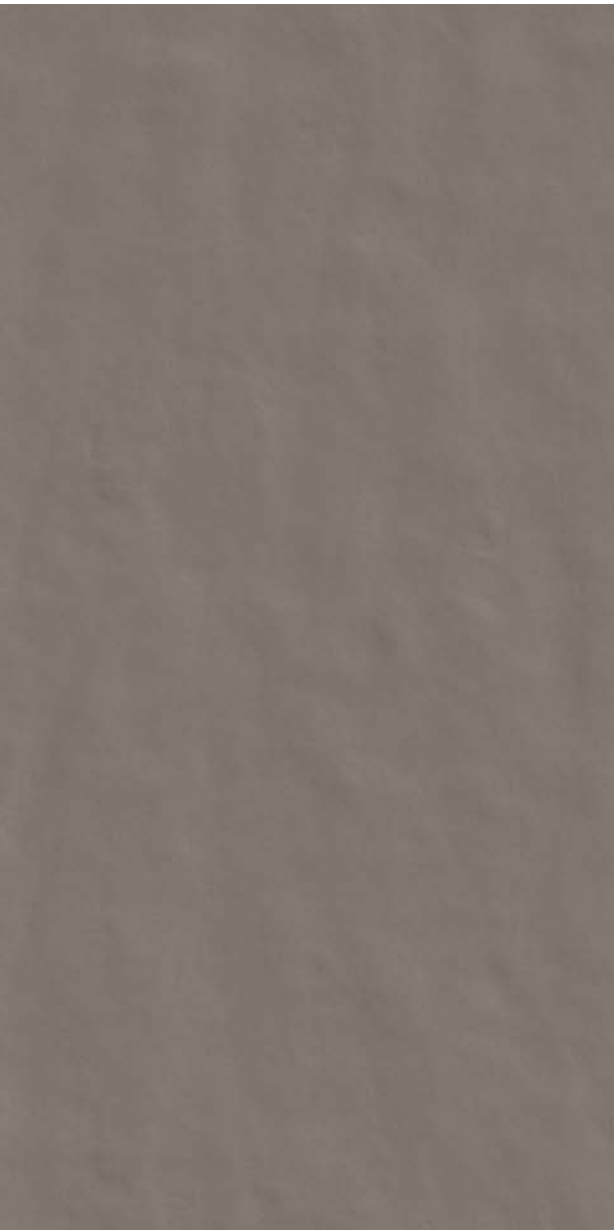

GRES PORCELLANATO DECORATO
 DECORATED PORCELAIN TILES/GRÈS CÉRAMÉ DÉCORÉ /VERZIERTES FEINSTEINZEUG/GRES PORCELÁNICO DECORADO
 SQUADRATO - SQUARED - EQUARRI - REKTIFIZIERT - ESCUADRADO

6 mm 1/4" ↑↓		COLOR	SURFACE	120x240 47 ^{1/4"} x94 ^{1/2"}
NEUTRA 6.0		11 MELANZANA	NATURALE	749560 ■ FL-27900
		12 MALVA	NATURALE	749561 ■ FL-27900

NEUTRA 6.0

13 CORALLO

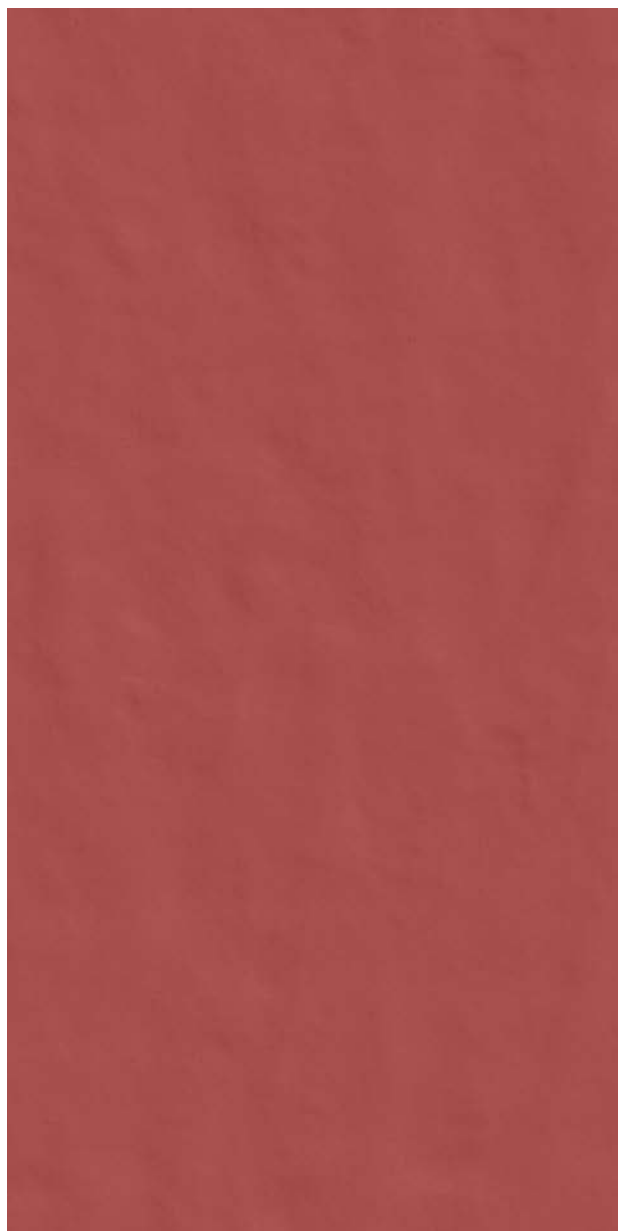

14 ARANCIO

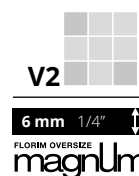

GRES PORCELLANATO DECORATO
 DECORATED PORCELAIN TILES/GRÈS CÉRAMÉ DÉCORÉ /VERZIERTES FEINSTEINZEUG/GRES PORCELÁNICO DECORADO
 SQUADRATO - SQUARED - EQUARRI - REKTIFIZIERT - ESCUADRADO

6 mm 1/4" ↑↓		COLOR	SURFACE	120x240 47 ^{1/4"} x94 ^{1/2"}
NEUTRA 6.0		13 CORALLO	NATURALE	752898 ■ FL-27900
		14 ARANCIO	NATURALE	752899 ■ FL-27900

FLORIM OVERSIZE
magnUm

120x240
 Specifica Imballo pag.
 Packaging specifications on page
 Spécifications d'emballage à page
 Verpackungsdetail Seite
 Especificaciones de embalaje a la página
154/155

GRES PORCELLANATO DECORATO

DECORATED PORCELAIN TILES/GRÉS CÉRAMÉ DÉCORÉ/VERZIERTES FEINSTEINZEUG/GRES PORCELÁNICO DECORADO

AVVERTENZE / WARNINGS / AVERTISSEMENTS / HINWEISE / ADVERTENCIAS

<p>INDICAZIONI GENERALI GENERAL INSTRUCTIONS INDICATIONS GÉNÉRALES ALLGEMEINE HINWEISE INDICACIONES GENERALES</p>	<p>Florim indica di stoccare il materiale in magazzini coperti o al riparo da agenti atmosferici, coprendo il materiale con cappucci protettivi. È NECESSARIO EVITARE OGNI TIPO DI STROFINAMENTO O TRAUMA SUPERFICIALE DELLA LASTRA DURANTE TUTTE LE FASI DI MOVIMENTAZIONE POSA E STUCCATURA. I prodotti in gres porcellanato decorato sono realizzati con una tecnologia produttiva differente dai prodotti in gres porcellanato tradizionale. Nel caso in cui si intenda posare le due tipologie di materiale nello stesso ambiente si potrebbero verificare differenze di aspetto superficiale e "punto di colore". / Florim recommends storing the material in indoor warehouses or protected from the weather, covered with protective hoods. CARE MUST BE TAKEN TO PREVENT ANY RUBBING OF OR KNOCKS ON THE SURFACE OF THE SLAB THROUGHOUT ALL HANDLING, INSTALLATION AND GROUTING PHASES. The decorated porcelain stoneware products are made with a production technology which differs from traditional porcelain stoneware production. If you plan to install the two types of material in the same area, there could be differences in surface appearance and "color point". Florim précise de stocker le matériel dans des entrepôts couverts ou à l'abri des intempéries, en le recouvrant d'un capot protecteur. Les produits en grés porcellanato décoré sont fabriqués à l'aide d'une technologie de production différente des produits en grés céramé traditionnels. Si vous avez l'intention de poser les deux types de matériaux dans la même pièce, il pourrait y avoir des différences d'aspect de surface et de "point de couleur". / Florim empfiehlt, das Material in geschlossenen Lagern bzw. vor Witterung geschützt aufzubewahren und mit Schutzplanen abzudecken. BEI HANDLING, VERLEGUNG UND VERFUGUNG SIND REIBEKONTAKTE UND VERLETZUNGEN DER OBERFLÄCHE ZU VERMEIDEN. Die dekorierten Feinsteinzeugprodukte werden mit einer anderen Produktionstechnologie hergestellt als die traditionellen Feinsteinzeugprodukte. Wenn Sie die beiden Materialarten in derselben Umgebung verlegen möchten, kann es zu Unterschieden in Oberflächenoptik und Farbton kommen. Florim indica que el material debe guardarse, tapado con capuchos de protección, en almacenes cubiertos o al amparo de los agentes atmosféricos. DURANTE TODAS LAS FASES DE DESPLAZAMIENTO, COLOCACIÓN Y REJUNTADO EVITARSE CAUSAR CUALQUIER TIPO DE ROZAMIENTO O DE TRAUMA SOBRE LA SUPERFICIE DE LA PLACA. Los productos de gres porcelánico decorado se elaboran con una tecnología de producción diferente a los productos tradicionales de gres porcelánico. En el caso tal que se requiera colocar los dos tipos de material en el mismo entorno, pueden haber diferencias en la apariencia de la superficie y el "punto de color".</p>
<p>DESTINAZIONE D'USO RECOMMENDED APPLICATIONS DOMAINE D'APPLICATION ANWENDUNGSBEREICHE USO PREVISTO</p>	<p>Lastre decorate con innovative tecniche artigianali destinate esclusivamente al rivestimento di pareti interne. Eventuali piccole imperfezioni sono da considerarsi caratteristica propria di prodotto dovuta al processo produttivo. Questa innovativa tecnica decorativa migliora la definizione e la profondità dei colori, rendendo la resistenza superficiale all'abrasione meno performante rispetto al gres porcellanato tradizionale. Per questo motivo è necessario attenersi alle istruzioni riportate negli imballi (qualora non fossero presenti, è possibile consultare il sito internet). Il materiale è utilizzabile anche come rivestimento della parete della doccia. In questa destinazione d'uso, per la corretta posa in opera, Florim raccomanda di installare solo lastre intere o posizionare i tagli della lastra non a contatto con il piatto doccia. In caso di utilizzo come backspash, Florim richiede l'installazione delle lastre a una distanza minima di 20 cm dai fuochi del piano cottura. Si consiglia l'utilizzo del materiale come rivestimento di camini, stufe e, più in generale, la posa in prossimità di fonti di calore. / Slabs decorated by innovative hand techniques intended only for covering indoor walls. Any minor flaws are an intrinsic characteristic of the product, due to the production process. This innovative decorative technique improves the definition and depth of the colours but reduces resistance to surface abrasion compared to standard porcelain stoneware. The instructions provided inside the packaging must therefore be complied with (if not found, refer to the website). The material can also be used to cover the walls of showers. For this intended use, for correct installation, Florim advises you to install whole slabs only, or to ensure that cut edges of slabs are not in contact with the shower tray. In case of use as a backspash, Florim specifies that slabs must be installed at least 20 cm from hob burners. The material is not recommended for use for covering fireplaces or stoves, or for installation close to heat sources in general. / Dalles décorées par des techniques artisanales modernes, à utiliser exclusivement pour le revêtement des murs intérieurs. Les petites imperfections éventuelles doivent être considérées comme des caractéristiques du produit. Cette technique décorative innovatrice améliore la définition et la profondeur des couleurs, mais diminue la résistance à l'abrasion de la surface. Pour cette raison, les instructions contenues dans les emballages doivent être suivies à la lettre (si la boîte ne les contient pas, il est possible de consulter le site Internet). Le produit peut être posé aussi sur le mur de la douche. Dans ce cas, pour un bon résultat de pose, Florim conseille d'installer uniquement des dalles entières ou de ne pas mettre les découpes de la dalle en contact avec le receveur. Si les dalles sont posées en dossier, Florim préconise de ne pas les placer à moins de 20 cm des feux de la table de cuisson. Il est déconseillé d'utiliser le produit pour revêtir des cheminées, des poêles et, de manière plus générale, de le poser à proximité de sources de chaleur. / Dekorierte Platten, hergestellt mit modernen Handwerkstechniken, ausschließlich für die Wandverkleidung im Innenbereich. Etwas geringfügige Unregelmäßigkeiten sind keine Mängel, sondern ein typisches, verfahrenstechnisch bedingtes Produktmerkmal. Dieses innovative Dekorationsverfahren verbessert die Farbdefinition und -tiefe bei gleichzeitig verringerter Abriebfestigkeit gegenüber herkömmlichem Feinsteinzeug. Aus diesem Grund beachten Sie bitte genau die beigelegte Anleitung (sollten diese nicht vorhanden sein, informieren Sie sich bitte auf der Website). Das Material kann auch für die Wandverkleidung von Duschnischen verwendet werden. In diesem Fall empfiehlt Florim, nur ganze Platten zu verlegen bzw. die Schnittflächen der Platte nicht im Kontakt mit der Duschwanne zu verlegen. Bei Verwendung für Fliesenspiegel soll der Abstand der Platten von den Herdstellen des Kochfelds mindestens 20 cm betragen. Die Verwendung der Platten für die Verkleidung von Kaminen und Öfen bzw. die Verwendung in der Nähe von Wärmequellen wird nicht empfohlen. / Placas decoradas con innovadoras técnicas artesanales destinadas exclusivamente al revestimiento de paredes interiores. Toda posible pequeña imperfección ha de considerarse característica propia del producto debida al proceso de fabricación. Esta innovadora técnica decorativa mejora la definición y la profundidad de los colores, pero hace que la resistencia superficial a la abrasión sea menor con respecto a la que presenta el gres porcelánico tradicional. Por este motivo hay que atenerse a las instrucciones que se encuentran en los embalajes (si no las hay, siempre pueden consultarse en el sitio web). El material también se puede utilizar para revestir la pared de la ducha. En el caso de este tipo de aplicación, para una correcta colocación, Florim recomienda instalar únicamente placas enteras o situar los recortes de placas donde no entren en contacto con el plato de la ducha. En caso de uso como salpicadero, Florim exige la colocación de las placas a una distancia mínima de 20 cm de los fogones de la superficie de cocción. Se desaconseja el empleo de este material para revestir chimeneas, estufas y, más en general, superficies cercanas a fuentes de calor.</p>
<p>MOVIMENTAZIONE HANDLING MANUTENTION TRANSPORT UND HANDHABUNG DESPLAZAMIENTO</p>	<p>Nella movimentazione evitare il contatto con materiali abrasivi e lo strofinamento con altre lastre o con il piano di lavoro. Non appoggiare sulla superficie utensili o altro materiale che potrebbe danneggiare il prodotto. Si consiglia di movimentare le lastre utilizzando appositi telai a ventosa, assicurandosi che le ventose siano perfettamente pulite e avendo cura di: -utilizzare ventose dotate di vacuometro per valutare/verificare la correttezza e costante adesione delle ventose stesse alla lastra (per movimentare lastre lucide è possibile mantenere la pellicola); - definire il numero di operatori addetti alla fase di movimentazione sulla base del peso totale (lastra più telaio) da sollevare e di eventuali limiti imposti da norme antinfortunistiche. - ridurre al minimo (pochi metri) il tragitto di movimentazione manuale con ventosa. / When handling, avoid contact with abrasive materials or rubbing against other slabs or the work surface. Do not place tools or any other material which might damage the product on or on the surface. Special suction cup frames should be used, when handling slabs, making sure that the suction cups are perfectly clean and always - using suction cups with vacuum meter, for measuring/checking correct, constant adhesion between the suction cups and the slab (when handling glossy slabs, the film can be left in place); - deciding the number of workers to be assigned to handling operations on the basis of the total weight (slab plus frame) to be lifted and any limits set by safety regulations; - minimising (to just a few metres) the distance over which slabs are carried by hand with suction cup. / Pendant la manutention, éviter tout contact avec les matériaux abrasifs et tout frottement avec d'autres dalles ou avec le plan de travail. Ne pas poser sur la surface des outils ou autre matériel susceptibles d'endommager le produit. Il est recommandé d'utiliser les araignées à ventouses pour manutentionner les dalles en s'assurant que les ventouses sont parfaitement propres et en veillant à: - utiliser des ventouses avec un vacuomètre pour mesurer/vérifier la justesse et l'adhésion constante des ventouses à la dalle (pour manutentionner des ventouses brillantes il est possible de maintenir la pellicole); - définir le nombre d'opérateurs nécessaires à la manutention selon le poids total (dalle + araignée) à soulever et selon les éventuelles restrictions imposées par les normes relatives à la prévention des accidents; - réduire au minimum (quelques mètres) le parcours de manutention manuelle avec ventouse. / Bei der Handhabung sind der Kontakt mit scheuernden Materialien und der Reibecontact mit anderen Platten oder der Werkbank zu vermeiden. Werkzeuge oder anderweitige Gegenstände, die das Produkt beschädigen könnten, dürfen nicht auf der Oberfläche abgelegt werden. Es wird empfohlen, für das Tragen und Heben der Platten einen Heberahmen mit Saugtellern zu verwenden. Hierbei ist sicherzustellen, dass die Saugteller vollkommen sauber sind, und ist auf Folgendes zu achten: -Die Saugteller sollen mit einem Vakuummeter ausgestattet sein, um Ihre sichere und konstante Haftung an der Platte beurteilen/kontrollieren zu können (für das Handling von glänzenden Platten kann die Schutzfolie an Ort und Stelle verbleiben). - Die Anzahl der Mitarbeiter für das Handling auf der Grundlage des Gesamtgewichtes (Platte plus Heberahmen) und etwaiger Sicherheitsvorgaben zum Unfallschutz bestimmen. - Der Transportweg für das manuelle Handling der Platte ist auf ein Mindestmaß (wenige Meter) zu reduzieren. / En el desplazamiento evitarse el contacto con materiales abrasivos y el roce con otras placas o con la superficie de trabajo. No depositar sobre la superficie herramientas ni ningún material que pueda dañar el producto. Se aconseja desplazar las placas utilizando bastidores dotados de ventosas, cerciorándose previamente de que estas estén perfectamente limpias y procurando: - utilizar ventosas provistas de vacuómetro para evaluar/verificar la correcta y constante adhesión de las mismas a la placa (en caso de desplazar placas brillantes puede mantenerse la película de protección); - establecer el número de operarios que va a encargarse del desplazamiento en función del peso total (placa más bastidor) que haya de levantarse y de las posibles limitaciones que las normas de prevención de accidentes impongan; - reducir al mínimo (a unos pocos metros) el trayecto de desplazamiento manual con ventosa.</p>
<p>TAGLIO/FORO CUTTING/DRILLING DÉCOUPE/TROU SCHNEIDEN/BOHREN CORTE/ORIFICIO</p>	<p>Verificare che il piano di appoggio sia perfettamente stabile, piano, pulito e privo di ogni asperità che possa danneggiare il materiale; è possibile usare come protezione della superficie, quando necessario, il foglio "protettivo/distanziatore" contenuto nell'imballaggio. Come tagliare le lastre delle diverse collezioni: Neutra 6.0: incidere il retro della lastra utilizzando appositi strumenti da taglio per lastre avendo cura di tagliare a fondo. / Check that the supporting surface is perfectly stable, flat and clean and does not have any rough areas which may damage the material. The "protective/spacer" sheet provided in the packaging can be used to protect the surface when necessary. How to cut slabs from the various collections: Neutra 6.0: cut into the back of the slab using suitable slab cutting tools, taking care to remove any protective film before cutting. / S'assurer que la surface d'appui est parfaitement stable, plane, propre et sans irrégularités susceptibles d'endommager le produit. Il est possible d'utiliser la feuille de protection/d'espacement contenue dans l'emballage pour protéger la surface, si nécessaire. Comment découper les dalles des différentes collections: Neutra 6.0: faire une amorce au dos de la dalle en utilisant les outils de coupe pour dalles en veillant à retirer, avant la coupe, l'éventuel film de protection. / Kontrollieren, dass die Arbeitsunterlage vollkommen stabil, plan und sauber ist und keine Unebenheiten vorhanden sind, die zu Beschädigungen der Oberfläche führen könnten. Wie schneiden Sie die Platten? Neutra 6.0: Die Platten rückseitig unter Verwendung von Plattenschneidwerkzeugen anritzen, nachdem die Schutzfolie, sofern vorhanden, entfernt wurde./Comprobar que la superficie sobre la que depositamos las placas sea estable, plana, esté perfectamente limpia y carezca de asperezas que puedan dañar el material; cuando sea necesario, para proteger la superficie, podrá usarse la hoja "protectora/distanziadora" que se encontrará en el embalaje. Cómo cortar las placas de las varias colecciones: Neutra 6.0: practicar una incisión en la parte posterior de la placa sirviéndose de oportunas herramientas de corte para placas; antes de proceder al corte retirar la película de protección, si la hay.</p>
<p>POSA INSTALLATION POSE VERLEGUNG COLOCACIÓN</p>	<p>Si sconsiglia l'uso di distanziatori livellanti tradizionali. È possibile utilizzare i livellanti a vite dotati di guarnizione protettiva (che deve essere assolutamente pulita per evitare di rovinare la superficie). / It is not recommended to use leveling spacers. It is possible to use leveling screws with a protective gasket (which must be absolutely clean to avoid damaging the slab) may be used. / Il est déconseillé d'utiliser les croisillons nivelants traditionnels. Il est possible d'utiliser les croisillons à vis avec joint de protection (qui doit être absolument propre pour éviter d'abîmer/de marquer la dalle). / Die Verwendung von herkömmlichen Verlegehilfen wird nicht empfohlen. Es können Verlegehilfen mit Schraubsystem verwendet werden, die mit einer Schutzdichtung ausgestattet sind (diese muss vollkommen sauber sein, damit keine Beschädigungen/Kratzer an der Platte entstehen). / Se desaconseja el uso de separadores de nivelación tradicionales. Se pueden utilizar separadores de nivelación de tornillo dotados de guarnición de protección (que ha de estar perfectamente limpia para evitar estropear/arañar la placa).</p>
<p>STUCCATURA GROUTING RÉALISATION DES JOINTS VERFUGEN REJUNTADO</p>	<p>Si consiglia l'uso di soli sigillanti cementizi a grana fine e spatole in materiale plastico. Si sconsiglia l'uso di silicone acetoico come sigillante. (Attenzione: la pellicola, quando presente, non deve impedire il corretto e completo riempimento della fuga). Proteggere con scotch di carta la superficie prima della sigillatura. Neutra 6.0: utilizzare scotch di carta sui perimetri e successivamente applicare il sigillante con spatola di gomma. / Only fine-grain cement grouts and plastic trowels should be used. (The use of acetoxy silicone as a grout is not recommended. (Important: any film present must not prevent correct, complete filling of the joint). Matte Neutra 6.0: use masking tape around the edges and then apply the grout with a rubber trowel. / Il est recommandé d'utiliser uniquement des mortiers-ciments à grains fins et des spatules en plastique. Il est déconseillé d'utiliser un silicone acétique pour l'exécution des joints. (Attention: le film de protection, si présent, ne doit pas entraver le remplissage complet du joint). Matte Neutra 6.0: utiliser du ruban papier adhésif. Neutra 6.0 mate: mettre un ruban papier adhésif sur les bords, puis appliquer le mortier avec une spatule en caoutchouc. / Für die Verfugung empfehlen wir, ausschließlich feinkörnigen zementären Fugenmortel und einen Gummschieber zu verwenden. Die Verwendung von Acetatsilikonen wird nicht empfohlen. (Achtung: Sofern vorhanden, darf die Schutzfolie nicht die korrekte und vollständige Ausfüllung der Fuge behindern). Die Plattenoberfläche vor dem Verfugen mit Papierklebeband abkleben. Neutra 6.0 matte: Randbereich mit Papierklebeband abkleben und anschließend Fugenmortel mit Gummschieber auftragen. / Se recomienda emplear exclusivamente selladores cementosos de grano fino y espátulas de plástico. Se desaconseja el uso de silicona acética para sellar. (Ojo) La película de protección, cuando la haya, no debe impedir el correcto y completo llenado de las juntas). Antes de sellar protéjase la superficie con cinta de papel. Neutra 6.0 mate: colocar cinta adhesiva de papel a lo largo de los perímetros y a continuación aplicar el sellador con la espátula de goma.</p>
<p>PULIZIA POST POSA POST-INSTALLATION CLEANING NETTOYAGE APRES POSE ERSTREINIGUNG LIMPIEZA TRAS LA COLOCACIÓN</p>	<p>Avere cura di pulire i residui prima dell'indurimento dello stucco con acqua e spugna non abrasiva evitando di danneggiare la superficie della lastra. / Clean away residues thoroughly before the grout sets using water and a non-abrasive sponge, taking care not to damage the surface of the slab. / Avant le durcissement du mortier, prendre soin d'éliminer les résidus avec de l'eau et une éponge douce. / Verwenden Sie saubere, nicht-abrasive Schwämme, um die Rückstände vor dem Aushärten des Mörtels mit Wasser gründlich zu entfernen, wobei Sie darauf achten, dass die Oberfläche nicht beschädigt wird. / Antes de que se endurezcan, limpie los restos de rejunte con agua y una esponja no abrasiva procurando no estropear la superficie de la placa.</p>
<p>PULIZIA QUOTIDIANA DAILY MAINTENANCE ENTRETIEN QUOTIDIEN UNTERHALTSREINIGUNG LIMPIEZA COTIDIANA</p>	<p>Utilizzare detergenti neutri e/o acqua, pulendo con straccio in microfibra o spugna morbida. Prodotti acidi anticalcare possono essere utilizzati avendo cura di risciacquare rapidamente la superficie con acqua dopo l'applicazione. Non utilizzare solventi (alcol e simili) né spugne abrasive. / Use neutral detergents and/or water, cleaning with a microfibre cloth or soft sponge. Acid limescale remover products may be used, but take care to rinse the surface with water quickly after application. Do not use solvents (alcohols and similar substances) or abrasive sponges. / Laver avec des détergents neutres et/ou de l'eau, avec un chiffon microfibre ou une éponge douce. Les produits acides anticalcaires peuvent être utilisés à condition de rincer rapidement la surface à l'eau après application. Ne pas utiliser de solvants (alcools et similaires) ni d'éponges abrasives. / Neutrale Reinigungsmittel und/oder Wasser sowie ein Mikrofasertuch oder einen weichen Schwamm verwenden. Bei Verwendung von säurehaltigen Kalkentferner ist die Oberfläche unverzüglich mit Wasser nachzuspülen. Keine Lösemittel (Alkohol o.Ä.) und Scheuerschwämme verwenden. Utilizar detergentes neutros y/o agua y limpiar con trapos de microfibra o esponjas suaves. Se pueden utilizar productos ácidos antical siempre y cuando, tras su aplicación, se aclare de inmediato la superficie con agua. Evitese el uso de esponjas abrasivas y de disolventes (como alcohol o similares).</p>

Lastre decorate destinate esclusivamente al rivestimento di pareti interne./Decorated panels designed exclusively for tiling interior walls./ Dalles décorées, exclusivement destinées au revêtement de parois intérieures./Verzierte Platten, ausschließlich zur Verkleidung von Innenwänden bestimmt./Losas decoradas destinadas exclusivamente al revestimiento de paredes interiores.

Gres porcellanato decorato: florim indica di stoccare il materiale in magazzini coperti o al riparo da agenti atmosferici / Florim recommends to stock the goods in covered warehouses, do not expose to the elements Florim conseille de stocker le matériel dans des entrepôts couverts ou à l'abri des agents atmosphériques / Florim empfiehlt, das Material in geschlossenen Lagern oder in vor Witterungseinflüssen geschützten Bereichen zu lagern. / Florim indica almacenar el material en locales cubiertos o protegido de los agentes atmosféricos.

NEUTRA 6.0

NEUTRA 6.0 DECOR

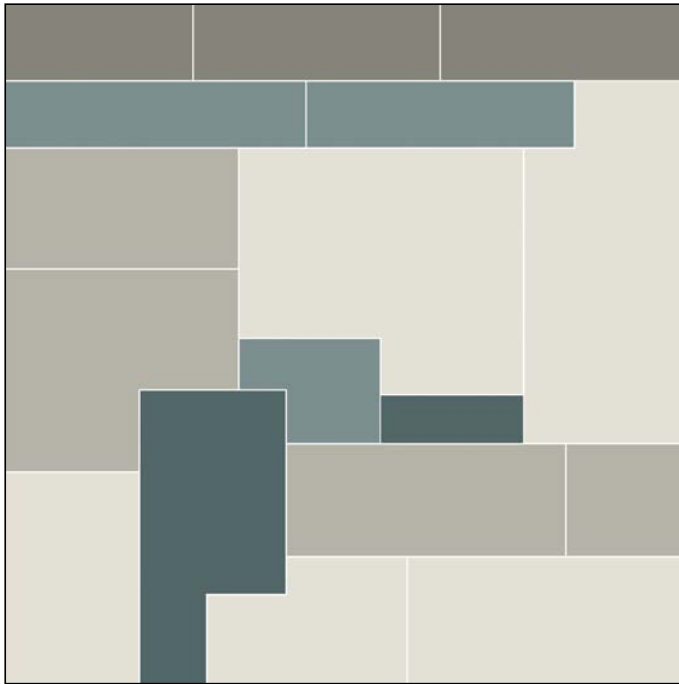

6 mm 1/4" ↓	240x240 94 ^{1/2} "x94 ^{1/2} "
NEUTRA 6.0	752957 ■ FL-87800

8 Tinte Unite 01 - 10. Destinazione d'uso: pavimento rivestimento

Intended use: floor and wall

Utilisation prévue: sol et revêtement

Anwendungsbereiche: Boden- und Wandbelag

Usa previsto: pavimento y revestimiento

6 Colori 11 - 14. Destinazione d'uso: rivestimento

Intended use: wall

Utilisation prévue: revêtement

Anwendungsbereiche: ausschliesslich Wandbelag

Usa previsto: revestimiento

Per il decoro è possibile selezionare i colori nel modo in cui si desidera.

For the decoro you can select colors combining them in the way you prefer.
Bezüglich des Dekors ist es möglich, die gewünschte Farbe frei auszuwählen.
Para la decoración es posible seleccionar los colores de manera deseada.
Pour le décor, il est possible de sélectionner les couleurs souhaitées.

NEUTRA 6.0	scatola - box			pallet		
	pz	mq	kg	box	mq	kg
240x240 DECOR	1	1,00	23,00	6	6,00	160
70,8x61,4 SHADES DECOR	3	1,30	18,90	20	26,08	400

GRES PORCELLANATO DECORATO

DECORATED PORCELAIN TILES - GRÉS CÉRAMÉ DÉCORÉ - VERZIERTES FEINSTEINZEUG - GRES PORCELÁNICO DECORADO
SQUADRATO - SQUARED - EQUARRI - REKTIFIZIERT - ESQUADRADO



01 Shades Decor

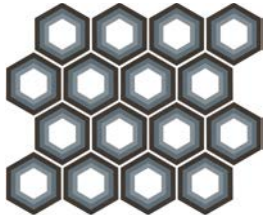

70,8x61,4
27^{7/8}"x24^{1/8}"
752904
■ FL-45000

02 Shades Decor

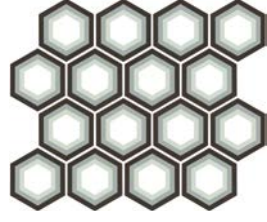

70,8x61,4
27^{7/8}"x24^{1/8}"
752905
■ FL-45000

03 Shades Decor

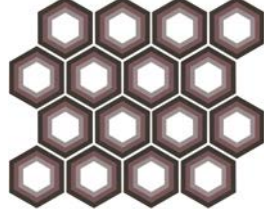

70,8x61,4
27^{7/8}"x24^{1/8}"
752906
■ FL-45000

04 Shades Decor

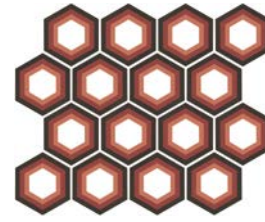

70,8x61,4
27^{7/8}"x24^{1/8}"
752907
■ FL-45000

Avvertenze per la posa e pulizia

Caratteristiche del prodotto: Gli articoli SHADES 01-02-03-04 di Neutra 6.0 sono prodotti mediante un nuovo sistema produttivo che non prevede la cottura ad alte temperature come le piastrelle tradizionali. Questa tecnologia grazie ad un processo produttivo di qualità, in parte ancora artigianale, permette di raggiungere risultati estetici e cromatici di altissimo livello dove sfumature e leggere variazioni cromatiche sono da considerare unità del prodotto. Utilizzare tali articoli solo per rivestire pareti interne agli edifici.

Avvertenze per la posa del materiale: Nella movimentazione evitare il contatto con materiali abrasivi e lo strofinamento con altre lastre o con il piano di lavoro. Non appoggiare sulla superficie utensili o altro materiale che potrebbero danneggiare il prodotto. Per il taglio del materiale incidere la superficie con taglierina per gres porcellanato, poi spezzare il decoro con il diamante dello strumento in dotazione (in alternativa usare apposita pinza troncatrice per gres porcellanato). Per ottenere un buon risultato, non staccare mai la lama dalla lastra durante l'intera operazione. Altri metodi di taglio sono sconsigliati in quanto potrebbero frastagliare la decorazione ai bordi o rompere le esagone che compongono la lastra. Proteggere i bordi delle esagone prima di stuccatura con normale scotch di carta. Sigillare le fughe con stucchi preferibilmente cementizi, dopo la stuccatura rimuovere immediatamente eventuali residui utilizzando una spugna morbida ed acqua calda, evitando in qualsiasi caso l'uso di acidi o remover. Non utilizzare prodotti a base di silicone acetico per la sigillatura di infissi, docce o sanitari alla superficie ceramica (utilizzando in alternativa prodotti a natura neutra).

Pulizia del materiale: Pulire con panno morbido utilizzando solo acqua o detersivi neutri evitando alcool, acetone, detersivi acidi, basici e a base di pasta abrasiva. Per la pulizia dello sporco ostinato utilizzare prodotti sgrassanti reperibili in tutti i supermercati purché non a base alcalina.

Instructions for laying and cleaning

Product characteristics: The SHADES 01-02-03-04 items in the Neutra 6.0 collection are manufactured with a new production system that does not require high-temperature firing as in the case of traditional tiles. With its top-quality production process, parts of which are still carried out by hand, this technology enables very high-end results to be obtained in terms of aesthetics and colour, where shading and slight colour variations in should be viewed as unique product features. These items are to be used only for tiling interior walls in buildings.

Laying Instructions: When handling, avoid contact with abrasive materials and scraping against other tile slabs or against the work surface. Do not rest on the tile-surface tools or other materials that may damage the product. To cut the tile, score the surface with a porcelain tile cutter and then snap the decor tile with the diamond on the tool supplied (alternatively, use tile-cutting pliers suitable for porcelain tiles). To obtain good results, never lift the blade from the slab for the entire operation. It is not advisable to use other cutting methods, since they may create a jagged edge on the decoration or break the hexagons comprising the slab. Before grouting, protect the edges of the hexagons with ordinary adhesive paper tape. Seal the joints with grout, preferably cement-based; after grouting remove any residues immediately using a soft sponge and warm water, avoiding at all costs the use of acids or sealant removers. Do not use products based on acetic silicone for sealing windows and doors, showers or bathroom fixtures to the ceramic surface; use neutral-type products instead.

Cleaning: Clean with a soft cloth, using only water or neutral detergents; do not use alcohol, acetone, acid or basic detergents or those based on abrasive paste. To clean persistent dirt use degreasing products to be found in any supermarket, provided they are not alkaline-based.

Instructions pour la pose et le nettoyage

Caractéristiques du produit: Les articles SHADES 01-02-03-04 de Neutra 6.0 ont été soumis à un nouveau système de production qui ne prévoit pas la cuisson à de hautes températures comme pour les carreaux traditionnels. Cette technologie, grâce à un processus de production de qualité, en partie encore artisanal, permet d'obtenir des résultats esthétiques et chromatiques du plus haut niveau où les nuances et les légères variations chromatiques sont des caractéristiques uniques du produit. N'utiliser ces articles que pour revêtir les murs internes des bâtiments.

Instructions pour la pose du matériel: Lors de la manipulation, éviter le contact avec des matériaux abrasifs ainsi que le frottement avec d'autres dalles ou la surface de travail. Ne pas poser sur la surface du produit des outils ou autre matériel qui pourraient l'endommager. Découper la surface du matériau à l'aide d'un coupe-carreaux, puis rompre le décor avec le diamant de l'instrument fourni (utiliser sinon une pince coupante pour gres céramé). Pour obtenir un bon résultat, ne jamais éloigner la lame de la dalle durant toute l'opération. Toute autre méthode de découpe est déconseillée du fait qu'elle pourrait ébrécher les bords du décor ou rompre les hexagones de la dalle. Protéger les bords des hexagones avant le jointoiment avec du papier cache adhésif ordinaire.

Sceller les joints avec du mortier, de préférence à base de ciment; après le jointoiment, éliminer immédiatement tout résidu à l'aide d'une éponge souple et de l'eau chaude en évitant l'utilisation d'acides ou de décapants. Ne pas utiliser de produits à base de silicone acétique pour sceller les cadres, les douches ou les sanitaires sur la surface céramique (utiliser plutôt des produits neutres).

Nettoyage du matériel: Nettoyer avec un chiffon doux en utilisant uniquement de l'eau ou des détergents neutres et en évitant l'alcool, l'acétone, les détergents acides, basiques et abrasifs en pâte. Pour éliminer les résidus tenaces, utiliser des produits dégraissants acides que l'on trouve dans tous les supermarchés.

Hinweise zur Verlegung und Reinigung

Eigenschaften des Produkts: Die Artikel SHADES 01-02-03-04 von Neutra 6.0 werden mit einem neuen Produktionssystem hergestellt, das keinen Brand mit hohen Temperaturen, wie bei traditionellen Fliesen, vorsieht. Mit dieser Technologie können, dank eines teilweise noch handwerklich stattfindenden hochwertigen Produktionsverfahrens, ästhetische und farbliche Ergebnisse von allerhöchstem Niveau erreicht werden, bei denen Abschattungen und leichte Farbvariationen als Einzigartigkeit des Produktes zu betrachten sind. Diese Artikel dürfen nur zur Verkleidung von Gebäudeinnenwänden verwendet werden.

Hinweise zur verlegung des Materials: Bei der Handhabung ist der Kontakt mit abrasiven Materialien, das Gegeneinanderreiben mit anderen Platten bzw. das Reiben auf der Arbeitsfläche zu vermeiden. Es dürfen keine Werkzeuge oder sonstigen Materialien auf die Oberfläche gelegt werden, die das Produkt beschädigen könnten. Zum Schneiden des Materials ist mit einem Fliesenschneider für Feinsteinzeug die Oberfläche anzuritzen und daraufhin das Dekor mit dem Diamant des mitgelieferten Werkzeugs zu brechen (oder mit einer Fliesenbrechzange für Feinsteinzeug). Die Klinge während des gesamten Vorganges niemals von der Platte entfernen, damit ein gutes Ergebnis erzielt werden kann. Von anderen Schneidmethoden wird abgeraten, da sie die Dekoration an den Kanten auszacken oder die Sechsecke, aus denen sich die Platte zusammensetzt, brechen könnten. Die Kanten der Sechsecke sind vor der Ausfugung mit normalem Krepppapier-Klebeband zu schützen. Die Fugen vorzugsweise mit Zementär-Fugenmasse versiegeln; nach der Ausfugung sind eventuelle Rückstände unverzüglich mit einem weichen Schwamm und Warmwasser zu entfernen, wobei unbedingt immer die Verwendung von Säuren oder Removern zu vermeiden ist. Zum Versiegeln von Fenstern und Türen, Duschen oder sanitären Einrichtungen an keramischen Oberflächen dürfen keine Produkte auf Acetatsilikonbasis verwendet werden (sondern nur neutrale Produkte).

Reinigung des Materials: Mit einem weichen Tuch reinigen und dazu nur Wasser oder neutrale Reinigungsmittel verwenden, dabei Alkohol, Aceton, säurehaltige bzw. basische Reinigungsmittel und solche auf Basis von Schleifpaste vermeiden. Zur Entfernung von hartnäckigem Schmutz sind in allen Supermärkten erhältliche Entfetter zu verwenden, mit Ausnahme solche auf Alkalibasis.

Advertencias para la colocación y limpieza

Características del producto: Los artículos SHADES 01-02-03-04 de Neutra 6.0 son elaborados mediante un nuevo sistema de producción que no prevé la cocción a altas temperaturas, como las baldosas tradicionales. Gracias a un proceso de producción de alta calidad, parcialmente artesanal, esta tecnología permite alcanzar resultados estéticos y cromáticos de altísimo nivel, en los que los matices y las ligeras variaciones cromáticas se deben considerar parte de la unidad del producto. Utilice estos artículos solo para revestir paredes interiores.

Advertencias para la colocación del material: Durante el desplazamiento, evite el contacto con materiales abrasivos y el rozamiento con otras losas o con el plano de trabajo. No apoye sobre la superficie herramientas u otros elementos que puedan dañar el producto. Para cortar el material, incida la superficie con una cortadora para gres porcelánico y, a continuación, quieb্রে la decoración con el diamante del instrumento suministrado (en alternativa, utilice una pinza de corte para gres porcelánico). Para obtener un buen resultado, no separe la cuchilla de la losa durante toda la operación. Se desaconseja recurrir a otros métodos de corte, ya que podrían mellar la decoración en los bordes o romper los hexágonos que componen la losa. Antes del estucado, proteja los bordes de los hexágonos con cinta adhesiva de papel. Selle las juntas preferiblemente con estucos de cemento; después del estucado, quite inmediatamente los eventuales residuos, utilizando una esponja suave y agua caliente; evite en todo caso el uso de ácidos o solventes. No utilice productos a base de silicona acética para el sellado de puertas, ventanas, duchas o sanitarios a la superficie cerámica (en alternativa, utilice productos neutros).















Limpieza del material: Limpie con un paño suave, utilizando solo agua o detergentes neutros. Evite el uso de alcohol, acetona, detergentes ácidos, alcalinos y a base de pasta abrasiva. Para la limpieza de la suciedad persistente, utilice alguno de los productos desengrasantes disponibles en todos los supermercados, siempre que no sean de base alcalina.

Gres porcellanato decorato: florim indica di stoccare il materiale in magazzini coperti o al riparo da agenti atmosferici / Florim recommends to stock the goods in covered warehouses, do not expose to the elements Florim conseille de stocker le matériel dans des entrepôts couverts ou à l'abri des agents atmosphériques / Florim empfiehlt, das Material in geschlossenen Lagern oder in vor Witterungseinflüssen geschützten Bereichen zu lagern. / Florim indica almacenar el material en locales cubiertos o protegido de los agentes atmosféricos.

NEUTRA 6.0

PITTURA

PAINT - PEINTURE - ANSTRICH - PINTURA

	COLOR	SURFACE	 4,00 l
	01 BIANCO	SATINATA /EGGSHELL	750444 FL-03800 *
	02 POLVERE	SATINATA /EGGSHELL	750445 FL-04900 *
	03 PERLA	SATINATA /EGGSHELL	750446 FL-04900 *
	04 FERRO	SATINATA /EGGSHELL	750447 FL-04900 *
	05 QUARZO	SATINATA /EGGSHELL	750448 FL-04900 *
	06 GRAFITE	SATINATA /EGGSHELL	750449 FL-04900 *
	07 PETROLIO	SATINATA /EGGSHELL	750450 FL-04900 *
	08 AVIO	SATINATA /EGGSHELL	750451 FL-04900 *
	09 OLIVA	SATINATA /EGGSHELL	750452 FL-04900 *
	10 ACQUAMARINA	SATINATA /EGGSHELL	750453 FL-04900 *
	11 MELANZANA	SATINATA /EGGSHELL	750454 FL-04900 *
	12 MALVA	SATINATA /EGGSHELL	750455 FL-04900 *
	13 CORALLO	SATINATA /EGGSHELL	754323 FL-04900 *
	14 ARANCIO	SATINATA /EGGSHELL	754324 FL-04900 *

NEUTRA 6.0

* prezzo al Litro/price per litre/prix au litre/Preis pro Liter/precio por litro

Per la scheda di sicurezza consultare il sito www.florim.com/For the safety sheet go to www.florim.com/Pour de plus amples informations sur la fiche de sécurité, consultez le site www.florim.com.
com/Das Sicherheitsdatenblatt finden Sie unter www.florim.com/Para la ficha de seguridad consulte el sitio www.florim.com





ONYX&MORE

gres fine porcellanato
fine porcelain stoneware
grès cérame fin
feinsteinzeug-kollektionen
gres porcelánico fino





ONYX&MORE

Onyx&More è la nuova collezione di Creative design che esprime i principali tratti identificativi del brand. In Onyx&More l'armonico equilibrio tra eleganza e creatività si rivela nell'originale e insolita combinazione tra due materie lapidee molto diverse tra loro per proporre ambienti raffinati, accoglienti ed intimi. Onyx&More interpreta la sorprendente eleganza dell'onice, raffinata, luminosa e poetica, naturalmente arricchita da innesti in porfido, una materia lapidea dal carattere discreto ed informale. Lo sviluppo armonioso del disegno che si rivela accostando le lastre in ampie superfici è un fattore di distinzione, così come le pregiate finiture di superficie, lucida e brillante o delicatamente satinata.

Onyx&More is the new collection by Creative design that conveys main characteristic features of the brand. Onyx&More by reveals the harmonious balance between elegance and creativity through the original and unusual pairing of two very different stone materials to create refined, cosy and intimate environments. Onyx&More interprets the surprising elegance of onyx, refined, lustrous and poetic, naturally enriched with inserts of porphyry, a stone material which is more discreet and informal in character. The harmonious pattern sequence that is revealed by placing the large tiles together over large surfaces is a distinguishing trait, as are the fine surface finishes, glossy and brilliant or with a delicate satin finish.

Onyx&More est la nouvelle collection de Creative design qui exprime les principales caractéristiques de la marque. Dans la collection Onyx&More l'équilibre harmonieux entre élégance et créativité se révèle dans la combinaison insolite et originale de deux pierres très différentes l'une de l'autre pour proposer des espaces raffinés, accueillants et intimes. Onyx&More interprète l'élégance surprenante de l'onix, raffinée, lumineuse et poétique, naturellement enrichie d'incrustations en porphyre, une pierre au caractère discret et informel. Le développement harmonieux du dessin qui se révèle en rapprochant les dalles sur de vastes surfaces est un facteur de distinction tout comme les finitions de surface raffinées, polie et brillante ou délicatement satinée.

Onyx&More ist die neue Kollektion von Creative design, die die wichtigsten Merkmale der Marke zum Ausdruck bringt. In Onyx&More von zeigt sich die harmonievoll Balance zwischen Eleganz und Kreativität in der originellen und ungewöhnlichen Kombination zweier sehr unterschiedlicher Steinmaterialien für edle, einladende und intime Räume. Onyx&More interpretiert die überraschende raffinierte, strahlende und poetische Eleganz von Onyx, natürlich angereichert mit Porphyr-Einsätzen, einem dezenten und informellen Steinmaterial. Die harmonievoll Entwicklung des Musters, das beim großflächigen Aneinanderreihen der Platten zum Vorschein kommt, erweist sich genau wie die kostbaren Oberflächenausführungen, glänzend und leuchtend oder seidenmatt, als ein hervorstechendes Merkmal.

Onyx&More es la nueva colección de Creative design y expresa los principales rasgos característicos de la marca. En Onyx&More el equilibrio armónico entre elegancia y creatividad se revela en la original e insólita combinación entre dos materiales lapídeos muy distintos entre sí para proponer ambientes refinados, acogedores e íntimos. Onyx&More interpreta la sorprendente elegancia del ónix, refinado, luminoso y poético, naturalmente enriquecido con inserciones en pórfido, un material lapídeo con un carácter discreto e informal. El desarrollo armonioso del diseño, que se revela juntando las losas en superficies amplias, es un factor de distinción, así como los preciosos acabados de la superficie, luminosa y brillante o delicadamente satinada.

ONYX&MORE

WHITE ONYX



WHITE BLEND



9 mm 3/8" ↑↓







6 mm 1/4" ↑↓

FLOHM OVERSIZE
magnuM

GRES FINE PORCELLANATO

FINE PORCELAIN STONEWARE/GRES CERAME FIN/FEINSTEINZEUG-KOLLEKTIONEN/GRES PORCELANICO FINO
SQUADRATO - SQUARED - EQUARRI - REKTIFIZIERT - ESCUADRADO

9 mm 3/8" ↑↓		COLOR	SURFACE	80x180 31 1/2" x 70 5/8"	60x120 23 5/8" x 47 1/4"	80x80 31 1/2" x 31 1/2"	60x60 23 5/8" x 23 5/8"			
ONYX&MORE		WHITE ONYX	GLOSSY	765408 ■ FL-11900	765464 ■ FL-11300	765426 ■ FL-10800	765480 ■ FL-09100			
			SATIN	765402 ■ FL-10500	765454 ■ FL-09900	765419 ■ FL-09300	765474 ■ FL-07300			
		WHITE BLEND	GLOSSY	765409 ■ FL-11900	765466 ■ FL-11300	765427 ■ FL-10800	765483 ■ FL-09100			
			SATIN	765403 ■ FL-10500	765457 ■ FL-09900	765421 ■ FL-09300	765475 ■ FL-07300			
6 mm 1/4" ↑↓		COLOR	SURFACE	160x320 63" x 126"	160x160 63" x 63"	120x280 47 1/4" x 110 1/4"	120x240 47 1/4" x 94 1/2"	120x120 47 1/4" x 47 1/4"	80x80 31 1/2" x 31 1/2"	60x120 23 5/8" x 47 1/4"
ONYX&MORE		WHITE ONYX	GLOSSY	765980 ■ FL-18800	765996 ■ FL-16100	766028 ■ FL-15100	765894 ■ FL-14000	765924 ■ FL-12400	766013 ■ FL-10300	765960 ■ FL-11300
			SATIN	765971 ■ FL-15600	765990 ■ FL-13400	766020 ■ FL-12400	765880 ■ FL-11300	765913 ■ FL-09700	766002 ■ FL-08400	765953 ■ FL-09100
		WHITE BLEND	GLOSSY	765982 ■ FL-18800	765997 ■ FL-16100	766029 ■ FL-15100	765899 ■ FL-14000	765925 ■ FL-12400	766014 ■ FL-10300	765961 ■ FL-11300
			SATIN	765973 ■ FL-15600	765991 ■ FL-13400	766022 ■ FL-12400	765886 ■ FL-11300	765915 ■ FL-09700	766008 ■ FL-08400	765955 ■ FL-09100

WHITE PORPHYRY



**R10
CLASSE B**
DCOF>
0,42 Wet

9 mm 3/8" ↑↓



**R10
CLASSE B**
DCOF>
0,42 Wet

6 mm 1/4" ↑↓

FLOHM OVERSIZE
magnUm

GRES FINE PORCELLANATO
FINE PORCELAIN STONEWARE/GRES CERAME FIN/FEINSTEINZEUG-KOLLEKTIONEN/GRES PORCELANICO FINO
SQUADRATO - SQUARED - EQUARRI - REKTIFIZIERT - ESCUADRADO

9 mm 3/8" ↑↓	COLOR	SURFACE	80x180 31 1/2" x 70 5/7"	60x120 23 5/8" x 47 1/4"	80x80 31 1/2" x 31 1/2"	60x60 23 5/8" x 23 5/8"
ONYX&MORE	WHITE PORPHYRY	STRUTTURATO	765415 ■ FL-10500	765471 ■ FL-09900	765433 ■ FL-09300	765489 ■ FL-07300

6 mm 1/4" ↑↓	COLOR	SURFACE	120x240 47 1/4" x 94 1/2"	120x120 47 1/4" x 47 1/4"	60x120 23 5/8" x 47 1/4"
ONYX&MORE	WHITE PORPHYRY	STRUTTURATO	765904 ■ FL-11300	765931 ■ FL-09700	765966 ■ FL-09100

ONYX&MORE

GOLDEN ONYX



GOLDEN BLEND





9 mm 3/8" ↑↓





6 mm 1/4" ↑↓

FLOHM OVERSIZE
magnum

GRES FINE PORCELLANATO
FINE PORCELAIN STONEWARE/GRES CERAME FIN/FEINSTEINZEUG-KOLLEKTIONEN/GRES PORCELANICO FINO
SQUADRATO - SQUARED - EQUARRI - REKTIFIZIERT - ESCUADRADO

9 mm 3/8" ↑↓		COLOR	SURFACE	80x180 31 1/2"x70 5/8"	60x120 23 5/8"x47 1/4"	80x80 31 1/2"x31 1/2"	60x60 23 5/8"x23 5/8"
ONYX&MORE		GOLDEN ONYX	GLOSSY	765410 ■ FL-11900	765467 ■ FL-11300	765429 ■ FL-10800	765484 ■ FL-09100
			SATIN	765404 ■ FL-10500	765458 ■ FL-09900	765422 ■ FL-09300	765476 ■ FL-07300
		GOLDEN BLEND	GLOSSY	765412 ■ FL-11900	765468 ■ FL-11300	765430 ■ FL-10800	765485 ■ FL-09100
			SATIN	765405 ■ FL-10500	765459 ■ FL-09900	765423 ■ FL-09300	765477 ■ FL-07300

6 mm 1/4" ↑↓		COLOR	SURFACE	160x320 63"x126"	160x160 63"x63"	120x280 47 1/4"x110 1/4"	120x240 47 1/4"x94 1/2"	120x120 47 1/4"x47 1/4"	80x80 31 1/2"x31 1/2"	60x120 23 5/8"x47 1/4"
ONYX&MORE		GOLDEN ONYX	GLOSSY	765986 ■ FL-18800	765998 ■ FL-16100	766030 ■ FL-15100	765900 ■ FL-14000	765926 ■ FL-12400	766015 ■ FL-10300	765962 ■ FL-11300
			SATIN	765974 ■ FL-15600	765992 ■ FL-13400	766023 ■ FL-12400	765888 ■ FL-11300	765920 ■ FL-09700	766009 ■ FL-08400	765956 ■ FL-09100
		GOLDEN BLEND	GLOSSY	765987 ■ FL-18800	765999 ■ FL-16100	766032 ■ FL-15100	765901 ■ FL-14000	765927 ■ FL-12400	-	765963 ■ FL-11300
			SATIN	765977 ■ FL-15600	765993 ■ FL-13400	766025 ■ FL-12400	765890 ■ FL-11300	765921 ■ FL-09700	-	765957 ■ FL-09100

GOLDEN PORPHYRY



**R10
CLASSE B**

DCOF>
0,42 Wet

9 mm 3/8" ↑↓

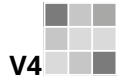

**R10
CLASSE B**

DCOF>
0,42 Wet

6 mm 1/4" ↑↓

FLOHM OVERSIZE
magnUm

GRES FINE PORCELLANATO
FINE PORCELAIN STONEWARE/GRES CERAME FIN/FEINSTEINZEUG-KOLLEKTIONEN/GRES PORCELANICO FINO
SQUADRATO - SQUARED - EQUARRI - REKTIFIZIERT - ESCUADRADO

9 mm 3/8" ↑↓	COLOR	SURFACE	80x180 31 1/2" x 70 6/7"	60x120 23 5/8" x 47 1/4"	80x80 31 1/2" x 31 1/2"	60x60 23 5/8" x 23 5/8"
ONYX&MORE	 GOLDEN PORPHYRY	STRUTTURATO	765417 ■ FL-10500	765472 ■ FL-09900	765434 ■ FL-09300	765491 ■ FL-07300

6 mm 1/4" ↑↓	COLOR	SURFACE	120x240 47 1/4" x 94 1/2"	120x120 47 1/4" x 47 1/4"	60x120 23 5/8" x 47 1/4"
ONYX&MORE	 GOLDEN PORPHYRY	STRUTTURATO	765907 ■ FL-11300	765933 ■ FL-09700	765967 ■ FL-09100

ONYX&MORE

SILVER ONYX



SILVER BLEND



9 mm 3/8" ↑↓



6 mm 1/4" ↑↓

FLOHM OVERSIZE
magnuM

GRES FINE PORCELLANATO
FINE PORCELAIN STONEWARE/GRES CERAME FIN/FEINSTEINZEUG-KOLLEKTIONEN/GRES PORCELANICO FINO
SQUADRATO - SQUARED - EQUARRI - REKTIFIZIERT - ESCUADRADO

9 mm 3/8" ↑↓		COLOR	SURFACE	80x180 31 1/2" x 70 5/8"	60x120 23 5/8" x 47 1/4"	80x80 31 1/2" x 31 1/2"	60x60 23 5/8" x 23 5/8"
ONYX&MORE		SILVER ONYX	GLOSSY	765413 ■ FL-11900	765469 ■ FL-11300	765431 ■ FL-10800	765486 ■ FL-09100
			SATIN	765406 ■ FL-10500	765460 ■ FL-09900	765424 ■ FL-09300	765478 ■ FL-07300
		SILVER BLEND	GLOSSY	765414 ■ FL-11900	765470 ■ FL-11300	765432 ■ FL-10800	765487 ■ FL-09100
			SATIN	765407 ■ FL-10500	765462 ■ FL-09900	765425 ■ FL-09300	765479 ■ FL-07300

6 mm 1/4" ↑↓		COLOR	SURFACE	160x320 63" x 126"	160x160 63" x 63"	120x280 47 1/4" x 110 1/4"	120x240 47 1/4" x 94 1/2"	120x120 47 1/4" x 47 1/4"	80x80 31 1/2" x 31 1/2"	60x120 23 5/8" x 47 1/4"
ONYX&MORE		SILVER ONYX	GLOSSY	765988 ■ FL-18800	766000 ■ FL-16100	766033 ■ FL-15100	765902 ■ FL-14000	765929 ■ FL-12400	766017 ■ FL-10300	765964 ■ FL-11300
			SATIN	765978 ■ FL-15600	765994 ■ FL-13400	766026 ■ FL-12400	765892 ■ FL-11300	765922 ■ FL-09700	766011 ■ FL-08400	765958 ■ FL-09100
		SILVER BLEND	GLOSSY	765989 ■ FL-18800	766001 ■ FL-16100	766034 ■ FL-15100	765903 ■ FL-14000	765930 ■ FL-12400	-	765965 ■ FL-11300
			SATIN	765979 ■ FL-15600	765995 ■ FL-13400	766027 ■ FL-12400	765893 ■ FL-11300	765923 ■ FL-09700	-	765959 ■ FL-09100

SILVER PORPHYRY



**R10
CLASSE B**

DCOF >
0,42 Wet

9 mm 3/8" ↑↓



**R10
CLASSE B**

DCOF >
0,42 Wet

6 mm 1/4" ↑↓











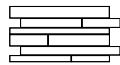

FLOHM OVERSIZE
magnUm

GRES FINE PORCELLANATO
FINE PORCELAIN STONEWARE/GRES CERAME FIN/FEINSTEINZEUG-KOLLEKTIONEN/GRES PORCELANICO FINO
SQUADRATO - SQUARED - EQUARRI - REKTIFIZIERT - ESCUADRADO

9 mm 3/8" ↑↓	COLOR	SURFACE	80x180 31 1/2" x 70 6/7"	60x120 23 5/8" x 47 1/4"	80x80 31 1/2" x 31 1/2"	60x60 23 5/8" x 23 5/8"
ONYX&MORE	 SILVER PORPHYRY	STRUTTURATO	765418 ■ FL-10500	765473 ■ FL-09900	765435 ■ FL-09300	765492 ■ FL-07300

6 mm 1/4" ↑↓	COLOR	SURFACE	120x240 47 1/4" x 94 1/2"	120x120 47 1/4" x 47 1/4"	60x120 23 5/8" x 47 1/4"
ONYX&MORE	 SILVER PORPHYRY	STRUTTURATO	765908 ■ FL-11300	765936 ■ FL-09700	765968 ■ FL-09100

ONYX&MORE

9 mm 3/8" ↓				30x30 11 4/5" x 11 4/5"	30x30 11 4/5" x 11 4/5"	30x60 11 4/5" x 23 5/8"	0,5x60 1/4" x 23 5/8"
	COLOR	SURFACE					
	WHITE ONYX	GLOSSY	767653 ■ FL-23600	767641 ■ FL-18300	767670 ■ FL-21000		719674 ▲ FL-03100
		SATIN	767662 ■ FL-19900	767646 ■ FL-15600	767674 ■ FL-18800		
	WHITE BLEND	GLOSSY	767759 ■ FL-23600	767752 ■ FL-18300	767772 ■ FL-21000		
		SATIN	767761 ■ FL-19900	767757 ■ FL-15600	767774 ■ FL-18800		
	WHITE PORPHYRY	STRUTTURATO	767667 ■ FL-19900	767650 ■ FL-15600	767678 ■ FL-18800		
	GOLDEN ONYX	GLOSSY	767655 ■ FL-23600	767642 ■ FL-18300	767671 ■ FL-21000		
		SATIN	767663 ■ FL-19900	767647 ■ FL-15600	767675 ■ FL-18800		
	GOLDEN BLEND	GLOSSY	767758 ■ FL-23600	767751 ■ FL-18300	767771 ■ FL-21000		
		SATIN	767760 ■ FL-19900	767756 ■ FL-15600	767773 ■ FL-18800		
	GOLDEN PORPHYRY	STRUTTURATO	767668 ■ FL-19900	767651 ■ FL-15600	767679 ■ FL-18800		
	SILVER ONYX	GLOSSY	767657 ■ FL-23600	767644 ■ FL-18300	767672 ■ FL-21000		
		SATIN	767665 ■ FL-19900	767648 ■ FL-15600	767676 ■ FL-18800		
	SILVER BLEND	GLOSSY	767658 ■ FL-23600	767645 ■ FL-18300	767673 ■ FL-21000		
		SATIN	767666 ■ FL-19900	767649 ■ FL-15600	767677 ■ FL-18800		
	SILVER PORPHYRY	STRUTTURATO	767669 ■ FL-19900	767652 ■ FL-15600	767680 ■ FL-18800		



I formati 160x160 e 80x240 posso essere acquistati solo a multipli di 2 lastre. / Sales unit for 160x160 and 80x240 is 2 pcs, so they can only be bought in multiples of 2. / Les formats 160x160 et 80x240 sont vendus par multiples de 2 plaques / Die Formate 160x160 und 80x240 können nur in einer durch 2 teilbaren Anzahl bestellt werden / Las medidas 160x160 y 80x240 solo pueden comprarse en múltiplos de 2 placas

In relazione alle differenti tecnologie produttive l'accostamento di prodotti con spessori diversi potrebbe presentare delle disomogeneità, se ne sconsiglia pertanto l'abbinamento. / Due to the different production technologies, contiguous installation of products with different thickness may give a non-homogeneous result. For this reason we do not recommend this option. / Vu que différentes technologies de production sont utilisées avec des épaisseurs différentes, des problèmes d'homogénéité pourraient se présenter, il est donc déconseillé de les poser ensemble. / Wegen unterschiedlicher Produktionstechnologien können die Fliesen mit verschiedenen Materialstärken optische Differenzen aufweisen. Von einem direkten Aneinanderlegen wird deshalb abgeraten. / Dadas las diferentes tecnologías productivas, la combinación de productos de diferentes espesores podría dar lugar a heterogeneidad, por lo que se desaconseja mezclarlas.

Per un effetto ottimale della posa, florim suggerisce di mantenere 2 mm di fuga per pose monofornate e 3 mm per combinare formati misti. - For optimal installation results, florim recommends maintaining a joint of 2 mm 1/12" for single format installations and 3 mm 1/8" to combine mixed formats. - Pour réaliser une pose parfaite, florim suggère de maintenir 2 mm de joint pour la pose des monofornats, et 3 mm pour les combinaisons de formats mixtes. - Um einen optimalen effekt beim verlegen zu erzielen empfiehlt florim eine 2 mm fuge bei einformatigen verlegungen und 3 mm fuge bei formatkombinationen. Para lograr los máximos resultados en la posa del producto, florim aconseja 2 mm de junta en aplicaciones monofornato y 3 mm en combinaciones de formatos mixtos

PEZZI SPECIALI/SPECIAL TRIMS/PIÈCES SPÉCIALES/FORMSTÜCKE/PIEZAS ESPECIALES

9 mm 3/8" 

4,6x60
1 4/5" x 23 5/8"



battiscopa

ONYX&MORE











	COLOR	SURFACE	
	WHITE ONYX	GLOSSY	767681 ◆ FL-01600
		SATIN	767685 ◆ FL-01600
	WHITE BLEND	GLOSSY	767776 ◆ FL-01600
		SATIN	767778 ◆ FL-01600
	WHITE PORPHYRY	STRUTTURATO	767689 ◆ FL-01600
	GOLDEN ONYX	GLOSSY	767682 ◆ FL-01600
		SATIN	767686 ◆ FL-01600
	GOLDEN BLEND	GLOSSY	767775 ◆ FL-01600
		SATIN	767777 ◆ FL-01600
	GOLDEN PORPHYRY	STRUTTURATO	767690 ◆ FL-01600
	SILVER ONYX	GLOSSY	767683 ◆ FL-01600
		SATIN	767687 ◆ FL-01600
	SILVER BLEND	GLOSSY	767684 ◆ FL-01600
		SATIN	767688 ◆ FL-01600
	SILVER PORPHYRY	STRUTTURATO	767691 ◆ FL-01600

ONYX&MORE	scatola - box			pallet		
	pz	mq	kg	box	mq	kg
80x180	2	2,88	57,60	20	57,60	1210
60x120	2	1,44	28,08	30	43,20	870
80x80	2	1,28	24,96	40	51,20	1030
60x60	3	1,08	21,06	40	43,20	870
30x30 mosaico	10	0,90	19,17	30	27,00	610
30x60 mod. list.sfalsato	4	0,72	15,34	24	17,28	400

ONYX&MORE	scatola - box			pallet		
	pz	ml	kg	box	mq	kg
4,6x60 battiscopa	14	8,40	8,40	-	-	-

ONYX&MORE

6 mm 1/4" 

	COLOR	SURFACE	30x30 1 1/4" x 1 1/4"  mosaico tessere 7,5x7,5 pz/box11	30x30 1 1/4" x 1 1/4"  mosaico tessere 7,5x15 pz/box 11
ONYX&MORE	 WHITE ONYX	GLOSSY	767692 ▲ FL-02100	767703 ▲ FL-02100
		SATIN	767696 ▲ FL-01800	767707 ▲ FL-01800
	 WHITE BLEND	GLOSSY	767780 ▲ FL-02100	767785 ▲ FL-02100
		SATIN	767783 ▲ FL-01800	767787 ▲ FL-01800
	 WHITE PORPHYRY	STRUTTURATO	767700 ▲ FL-01800	767711 ▲ FL-01800
	 GOLDEN ONYX	GLOSSY	767693 ▲ FL-02100	767704 ▲ FL-02100
		SATIN	767697 ▲ FL-01800	767708 ▲ FL-01800
	 GOLDEN BLEND	GLOSSY	767779 ▲ FL-02100	767784 ▲ FL-02100
		SATIN	767782 ▲ FL-01800	767786 ▲ FL-01800
	 GOLDEN PORPHYRY	STRUTTURATO	767701 ▲ FL-01800	767712 ▲ FL-01800
	 SILVER ONYX	GLOSSY	767694 ▲ FL-02100	767705 ▲ FL-02100
		SATIN	767698 ▲ FL-01800	767709 ▲ FL-01800
 SILVER BLEND	GLOSSY	767695 ▲ FL-02100	767706 ▲ FL-02100	
	SATIN	767699 ▲ FL-01800	767710 ▲ FL-01800	
 SILVER PORPHYRY	STRUTTURATO	767702 ▲ FL-01800	767713 ▲ FL-01800	

PEZZI SPECIALI/SPECIAL TRIMS/PIÈCES SPÉCIALES/FORMSTÜCKE/PIEZAS ESPECIALES

6 mm 1/4" 

4,6x80
1 4/5" x 3 1/2"



battiscopa

ONYX&MORE

	COLOR	SURFACE	
	WHITE ONYX	GLOSSY	767714 ◆ FL-01800
		SATIN	767718 ◆ FL-01800
	WHITE BLEND	GLOSSY	767789 ◆ FL-01800
		SATIN	767791 ◆ FL-01800
	GOLDEN ONYX	GLOSSY	767715 ◆ FL-01800
		SATIN	767719 ◆ FL-01800
	GOLDEN BLEND	GLOSSY	767788 ◆ FL-01800
		SATIN	767790 ◆ FL-01800
	SILVER ONYX	GLOSSY	767716 ◆ FL-01800
		SATIN	767720 ◆ FL-01800
	SILVER BLEND	GLOSSY	767717 ◆ FL-01800
		SATIN	767721 ◆ FL-01800

FLORIM OVERSIZE
magnUm

160x320/160x160/120x280/120x240
120x120/80x80/60x120

Specifica Imballo pag.
Packaging specifications on page
Spécifications d'emballage à page
Verpackungsdetail Seite
Especificaciones de embalaje a la página
154/155

ONYX&MORE OUTDOOR

Vantaggi tecnici - Technical advantages - Avantages techniques Technische Vorteile - Ventajas técnicas

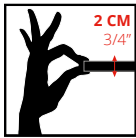

- Lastra monolitica compatta di spessore 2 cm squadrata e rettificata
- Compact monolithic slab 2 cm thick squared and rectified
- Dalle monolithique compacte de 2 cm d'épaisseur, équarrie et rectifiée
- Kompakte monolithische Platte, 2 cm dick, rechteckig und scharfkantig geschliffen
- Losa monolítica compacta de 2 cm de espesor, escuadrada y rectificada.

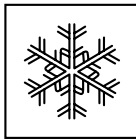

- INGELIVO
- FROST RESISTANT
- INGÉLIF
- FROSTBESTÄNDIG
- RESISTENTE A LA HELADA

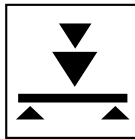

- ELEVATA RESISTENZA AI CARICHI STATICI
- HIGH STATIC LOAD RESISTANCE
- RÉSISTANCE ÉLEVÉE AUX CHARGES STATIQUES
- HOHE STATISCHE BELASTBARKEIT
- ELEVADA RESISTENCIA A LAS CARGAS ESTÁTICAS

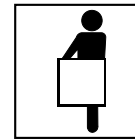

- FACILE DA POSARE
- EASY TO INSTALL
- FACILE À POSER
- VERLEGELEICHT
- FÁCIL DE COLOCAR



- ANTISCIVOLO R11
- ANTI SLIP R11
- ANTIDÉRAPANT R11
- RUTSCHFEST R11
- ANTIDESLIZANTE R11

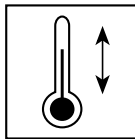

- RESISTENTE AGLI SBALZI TERMICI
- THERMAL SHOCK RESISTANT
- RÉSISTANT AUX ÉCARTS THERMIQUES
- TEMPERATURWECHSELBESTÄNDIG
- RESISTENTE A LAS OSCILACIONES TÉRMICAS



- FACILE DA PULIRE
- EASY TO CLEAN
- FACILE À NETTOYER
- REINIGUNGSLEICHT
- FÁCIL DE LIMPIAR

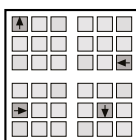

- RIMOVIBILE E RIUTILIZZABILE
- REMOVABLE AND REUSABLE
- DÉMONTABLE ET RÉUTILISABLE
- ENTFERNBAR UND WIEDERVERWENDBAR
- DESMONTABLE Y REUTILIZABLE



- INATTACCABILE DA AGENTI CHIMICI E MUFFE
- IMPERVIOUS TO ATTACK BY CHEMICALS OR MOULD
- RÉSISTANT AUX AGENTS CHIMIQUES ET AUX MOISSISSURES
- UNANGREIFBAR DURCH CHEMISCHE STOFFE UND SCHIMMEL
- RESISTENTE A LOS AGENTES QUÍMICOS Y A LOS MOHOS

Applicazioni - Applications - Applications - Verlegung - Aplicaciones

- Posa diretta su erba
- Direct installation on grass
- Pose direct sur de l'herbe
- Verlegung direkt auf Rasen
- Colocación directa sobre hierba

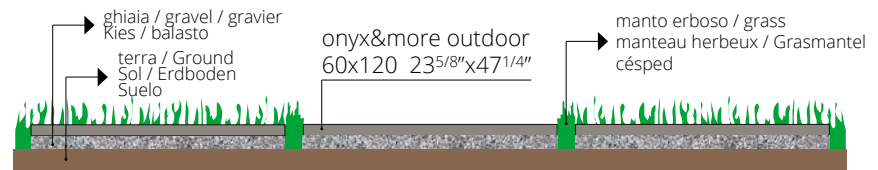

- Posa diretta su ghiaia
- Direct installation over gravel
- Pose direct sur du gravier
- Verlegung direkt auf Kies
- Colocación directa sobre grava



- Posa su massetto cementizio
- Installation on sand-cement screed
- Pose sur chape ciment
- Verlegung auf Zement-Unterbetonblock
- Colocación sobre contrapiso de hormigón

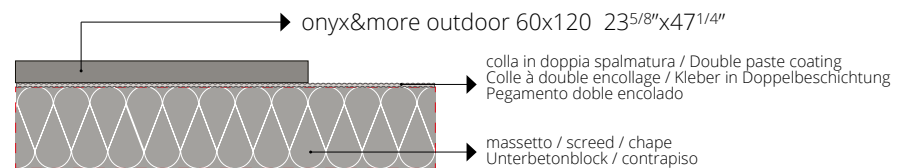

- Posa su piedini fissi o regolabili
- Installation on fixed or adjustable feet
- Pose sur pieds fixes ou réglables
- Verlegung auf feststehende oder regulierbare FüÙe
- Colocación sobre pies fijos o regulables

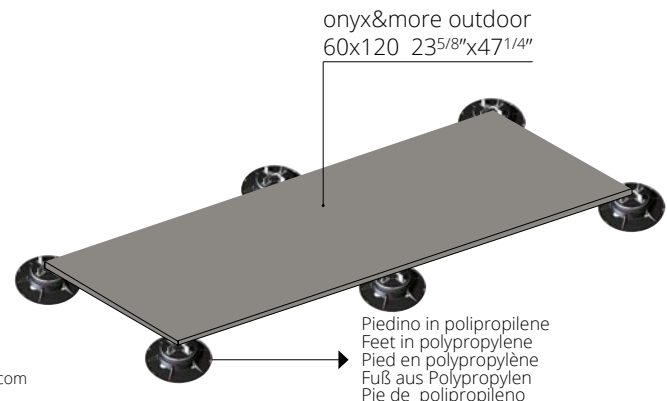

Per le specifiche di utilizzo dei sistemi sopraelevati vedi il sito florim.com
For the specifics on use of raised systems visit the site florim.com
Pour les caractéristiques d'utilisation des systèmes surélevés, voir le site florim.com
Für die Nutzungsbedingungen der Doppelbodensysteme siehe Webseite florim.com
Para las especificaciones de empleo de los sistemas sobreelevados consulte el sitio web florim.com

Le lastre ceramiche sono sottoposte a un trattamento di compattazione termica che assicura resistenza e durata nel tempo. Il bassissimo assorbimento d'acqua rende perciò il materiale ingelivo. Ciò può comportare ristagni d'acqua superficiali anche per materiale installato a regola d'arte. / Ceramic tiles undergo a compacting thermal treatment that ensures resistance and durability. The low level of water absorption makes the slabs frost resistant. This could result in superficial water stagnations even if materials are installed in a workmanlike manner. / Les carreaux de céramique subissent un traitement thermique de compactage qui assure résistance et durabilité. Le bas niveau d'absorption d'eau rend les dalles résistant au gel. Il pourrait en résulter des stagnations d'eau superficielles, même si les dalles ont été installées dans les règles de l'art. / Die Keramikplatten werden einer thermischen Verdichtung unterzogen, welche die Widerstandsfähigkeit und Langlebigkeit sichert. Die extrem niedrige Wasseraufnahme macht das Material frostsicher. Die hohe Materialdichte kann, auch bei einer perfekten Verlegung, eine längere Abtrochnungszeit von angestautem Wasser zur Folge haben. / Las baldosas cerámicas se someten a un tratamiento de compactación térmica que asegura resistencia y durabilidad. La baja absorción de agua hace que las baldosas resistan al hielo. Esto podría resultar en estancamientos superficiales de agua, incluso si los materiales están instalados según las reglas del arte.

WHITE PORPHYRY



GOLDEN PORPHYRY



R11
CLASSE C

DCOF >
0,42 Wet

20 mm 3/4" ↑↓



SILVER PORPHYRY



GRES FINE PORCELLANATO

FINE PORCELAIN STONEWARE/GRES CERAME FIN/FEINSTEINZEUG-KOLLEKTIONEN/GRES PORCELLANICO FINO
SQUADRATO - SQUARED - EQUARRI - REKTIFIZIERT - ESCUADRADO

20 mm 3/4" ↑↓

	COLOR	SURFACE	60x120 23 ⁵ / ₈ "x47 ¹ / ₄ "
ONYX&MORE	 WHITE PORPHYRY	STRUTTURATO	768509 ■ FL-11300
	 GOLDEN PORPHYRY	STRUTTURATO	768511 ■ FL-11300
	 SILVER PORPHYRY	STRUTTURATO	768512 ■ FL-11300



Recycled material content certification

PEZZI SPECIALI
Special trims/Pièces spèciales/Formstücke
Piezas especiales
pag 144/147

	RESISTENZA ALLA FLESSIONE IN N/mm ² N/mm ² FLEXURAL STRENGTH TEST / RESISTANCE A LA FLEXION EN N/mm ² / BIEGEFESTIGKEIT IN N/mm ² / RESISTENCIA A LA FLEXION EN N/mm ²	valore medio 52 N/mm ²
	Forza di rottura in N (sp. > 7,5 mm) Breaking strength in N (thickness > 7,5 mm) / Force de rupture en N (esp. > 7,5 mm) / Bruchlast in N (Dicke > 7,5 mm) / Fuerza de rotura en N (gr. > 7,5 mm)	valore medio 14000 N

ONYX&MORE	scatola - box			pallet		
	pz	mq	kg	box	mq	kg
60x120 20mm	1	0,72	32,26	30	21,60	1000



PIETRE/3

gres fine porcellanato
fine porcelain stoneware
grès cérame fin
feinsteinzeug-kollektionen
gres porcelánico fino





PIETRE/3

Pietre/3 è la naturale evoluzione di un progetto che ha segnato la storia di Creative design. Nella sua apparente semplicità è la diretta conseguenza di uno studio attento ai particolari e di un percorso creativo che si tiene lontano dalle mode effimere. Il valore dell'essenziale è all'origine della sua spiccata eleganza che resiste al passare del tempo. Una cifra stilistica colta e raffinata contraddistingue la scelta delle sfumature naturali che trasmettono un placido senso di nitore e misura negli spazi in cui si trovano. Inconsuete geometrie arricchiscono la collezione donandogli un diffuso senso di equilibrio e simmetria.

Pietre/3 is the natural evolution of a project that has marked the history of Creative design. In its apparent simplicity it is the direct result of a careful study, mindful of detail, and a creative path that steers clear of passing trends. The value of what is essential lies at the origin of a pronounced elegance that withstands the test of time. A cultured and refined stylistic figure distinguishes the choice of natural shades, to convey a placid sense of clearness and measure in the spaces they adorn. Unusual patterns enrich the collection, providing a widespread sense of balance and symmetry.

Pietre/3 est l'évolution naturelle d'un projet qui a marqué l'histoire de Creative design. Dans son apparente simplicité, c'est la conséquence directe d'une étude poussée des détails et d'un parcours créatif qui reste loin des modes éphémères. La valeur de l'essentiel est à l'origine de son élégance prononcée qui résiste au temps qui passe. Un caractère stylistique distinctif cultivé et raffiné caractérise le choix des nuances naturelles qui transmettent un paisible sens de clarté et de mesure dans les espaces où elles se trouvent. D'inhabituelles géométries enrichissent la collection en lui donnant un sens diffus d'équilibre et de symétrie.

Pietre/3 ist die natürliche Evolution eines Projekts, das die Geschichte von Creative design prägte. In seiner scheinbaren Schlichtheit ist es die direkte Konsequenz einer sorgfältigen Studie mit Beachtung der Einzelheiten und eines schöpferischen Wegs, der den vorübergehenden Moden fern bleibt. Aus dem Wert des Wesentlichen entspringt seine ausgeprägte Eleganz, die dem Lauf der Zeit widersteht. Ein kultivierter und eleganter stilistischer Kodex zeichnet die Wahl der natürlichen Farbtöne aus, die ein stilles Empfinden von Klarheit und Maß in den Räumen, in denen sie sich befinden, vermitteln. Ungewöhnliche Geometrien bereichern die Kollektion und verleihen ihr ein allgemeines Empfinden von Ausgeglichenheit und Symmetrie.

Pietre/3 es la evolución natural de un proyecto que ha marcado la historia de Creative design. En su aparente simplicidad, es la consecuencia directa de un estudio atento a los detalles y de un proceso creativo que se aparta de las modas efímeras. El valor de lo esencial está en el origen de su gran elegancia, que resiste el paso del tiempo. Un código estilístico culto y refinado caracteriza la selección de tonalidades naturales, que transmiten una placida sensación de pulcritud y mesura en los ambientes en que se encuentran. Insólitas geometrías enriquecen la colección, generando una difusa impresión de equilibrio y simetría.

PIETRE/3

LIMESTONE WHITE



LIMESTONE PEARL

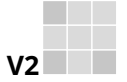



V2
R10
CLASSE B
 (matte)

R11
CLASSE C
 (strutturato)

DCOF >
 0,42 Wet

9 mm 3/8" ↑↓

GRES FINE PORCELLANATO
 FINE PORCELAIN STONEWARE/GRES CERAME FIN/FEINSTEINZEUG-KOLLEKTIONEN/GRES PORCELANICO FINO
 SQUADRATO - SQUARED - EQUARRI - REKTIFIZIERT - ESCUADRADO

9 mm 3/8" ↑↓		COLOR	SURFACE	80x180 31 1/2" x 70 6/7"	60x120 23 5/8" x 47 1/4"	80x80 31 1/2" x 31 1/2"	40x80 15 3/4" x 31 1/2"	60x60 23 5/8" x 23 5/8"	30x60 11 4/5" x 23 5/8"
PIETRE/3		LIMESTONE WHITE	MATTE	747632 ■ FL-11300	748376 ■ FL-09900	748346 ■ FL-08600	748352 ■ FL-06700	748370 ■ FL-06700	748364 ■ FL-05800
			STRUTTURATO	-	-	-	748358 ■ FL-06700	-	-
		LIMESTONE PEARL	MATTE	747633 ■ FL-11300	748378 ■ FL-09900	748348 ■ FL-08600	748354 ■ FL-06700	748372 ■ FL-06700	748366 ■ FL-05800
			STRUTTURATO	-	-	-	748360 ■ FL-06700	-	-

LIMESTONE ALMOND

LIMESTONE TAUPE

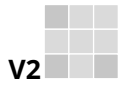



R10
CLASSE B
(matte)

R11
CLASSE C
(strutturato)

DCOF>
0,42 Wet

9 mm 3/8" ↑↓

GRES FINE PORCELLANATO
FINE PORCELAIN STONEWARE/GRES CERAME FIN/FEINSTEINZEUG-KOLLEKTIONEN/GRES PORCELANICO FINO
SQUADRATO - SQUARED - EQUARRI - REKTIFIZIERT - ESCUADRADO

9 mm 3/8" ↑↓		COLOR	SURFACE	80x180 31 1/2"x70 6/7"	60x120 23 5/8"x47 1/4"	80x80 31 1/2"x31 1/2"	40x80 15 3/4"x31 1/2"	60x60 23 5/8"x23 5/8"	30x60 11 4/5"x23 5/8"
PIETRE/3		LIMESTONE ALMOND	MATTE	747634 ■ FL-11300	748377 ■ FL-09900	748347 ■ FL-08600	748353 ■ FL-06700	748371 ■ FL-06700	748365 ■ FL-05800
			STRUTTURATO	-	-	-	748359 ■ FL-06700	-	-
		LIMESTONE TAUPE	MATTE	747636 ■ FL-11300	748379 ■ FL-09900	748349 ■ FL-08600	748355 ■ FL-06700	748373 ■ FL-06700	748367 ■ FL-05800
			STRUTTURATO	-	-	-	748361 ■ FL-06700	-	-

PIETRE/3

LIMESTONE ASH



LIMESTONE COAL





V3
R10
CLASSE B
 (matte)

R11
CLASSE C
 (strutturato)

DCOF >
 0,42 Wet









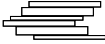

9 mm 3/8" ↑↓

GRES FINE PORCELLANATO
 FINE PORCELAIN STONEWARE/GRES CERAME FIN/FEINSTEINZEUG-KOLLEKTIONEN/GRES PORCELANICO FINO
 SQUADRATO - SQUARED - EQUARRI - REKTIFIZIERT - ESCUADRADO

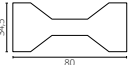
		COLOR	SURFACE	80x180 31 1/2"x70 6/7"	60x120 23 5/8"x47 1/4"	80x80 31 1/2"x31 1/2"	40x80 15 3/4"x31 1/2"	60x60 23 5/8"x23 5/8"	30x60 11 4/5"x23 5/8"
PIETRE/3		LIMESTONE ASH	MATTE	747635 ■ FL-11300	748380 ■ FL-09900	748350 ■ FL-08600	748356 ■ FL-06700	748374 ■ FL-06700	748368 ■ FL-05800
			STRUTTURATO	-	-	-	748362 ■ FL-06700	-	-
		LIMESTONE COAL	MATTE	747637 ■ FL-11300	748381 ■ FL-09900	748351 ■ FL-08600	748357 ■ FL-06700	748375 ■ FL-06700	748369 ■ FL-05800
			STRUTTURATO	-	-	-	748363 ■ FL-06700	-	-



PIETRE/3

9 mm 3/8" ↓				30x30 11 4/5" x 11 4/5"	30x30 11 4/5" x 11 4/5"	21x40 8 1/4" x 15 3/4"	30x30 11 4/5" x 11 4/5"	52,8x27,5 20 3/4" x 10 3/4"	34,5x80 13 1/2" x 31 1/2"
	COLOR	SURFACE							
			mosaico tessere 5x5 pz/box11	mosaico tessere 2,5x2,5 pz/box11	modulo listello sfalsato pz/box5	mosaico ellittico pz/box4	decoro trapezio pz/box4	decoro papillon pz/box2	
PIETRE/3		LIMESTONE WHITE	MATTE	748388 ▲ FL-01500	748394 ▲ FL-02700	748400 ▲ FL-01600	748406 ▲ FL-06200	748437 ▲ FL-02100	748438 ▲ FL-06000
		LIMESTONE PEARL	MATTE	748390 ▲ FL-01500	748396 ▲ FL-02700	748402 ▲ FL-01600	748408 ▲ FL-06200	748523 ▲ FL-02100	748528 ▲ FL-06000
		LIMESTONE ALMOND	MATTE	748389 ▲ FL-01500	748395 ▲ FL-02700	748401 ▲ FL-01600	748407 ▲ FL-06200	748522 ▲ FL-02100	748527 ▲ FL-06000
		LIMESTONE TAUPE	MATTE	748391 ▲ FL-01500	748397 ▲ FL-02700	748403 ▲ FL-01600	748409 ▲ FL-06200	748524 ▲ FL-02100	748529 ▲ FL-06000
		LIMESTONE ASH	MATTE	748392 ▲ FL-01500	748398 ▲ FL-02700	748404 ▲ FL-01600	748410 ▲ FL-06200	748525 ▲ FL-02100	748530 ▲ FL-06000
		LIMESTONE COAL	MATTE	748393 ▲ FL-01500	748399 ▲ FL-02700	748405 ▲ FL-01600	748411 ▲ FL-06200	748526 ▲ FL-02100	748531 ▲ FL-06000

0,5x60
1/4" x 23 5/8"

matita inox
pz/box 4











719674
▲ FL-03100

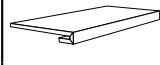

LIMESTONE WHITE/ LIMESTONE ALMOND/ LIMESTONE PEARL
LIMESTONE TAUPE/ LIMESTONE COAL

Per un effetto ottimale della posa, florim suggerisce di mantenere 2 mm di fuga per pose monofornate e 3 mm per combinare formati misti - For optimal installation results, florim recommends maintaining a joint of 2 mm 1/12" for single format installations and 3 mm 1/8" to combine mixed formats. - Pour réaliser une pose parfaite, florim suggère de maintenir 2 mm de joint pour la pose des monofornats, et 3 mm pour les combinaisons de formats mixtes. - Um einen optimalen effekt beim verlegen zu erzielen empfiehlt florim eine 2 mm fuge bei einformatigen verlegungen und 3 mm fuge bei formatkombinationen Para lograr los máximos resultados en la posa del producto, florim aconseja 2 mm de junta en aplicaciones monofornato y 3 mm en combinaciones de formatos mixtos

PEZZI SPECIALI/SPECIAL TRIMS/PIÈCES SPÉCIALES/FORMSTÜCKE/PIEZAS ESPECIALES

9 mm 3/8" 	COLOR	SURFACE	4,6x60 1 4/5" x 2 3/8"	40x33 1 5/8" x 1 3/8"	40x33 1 5/8" x 1 3/8"	40x33 1 5/8" x 1 3/8"
			 battiscopa	 gradino pz/box4	 angolo dx pz/box2	 angolo sx pz/box2
PIETRE/3	 LIMESTONE WHITE	MATTE	748412 ◆ FL-01600	748418 ▲ FL-07300	748424 ▲ FL-09100	748430 ▲ FL-09100
	 LIMESTONE PEARL	MATTE	748414 ◆ FL-01600	748420 ▲ FL-07300	748426 ▲ FL-09100	748432 ▲ FL-09100
	 LIMESTONE ALMOND	MATTE	748413 ◆ FL-01600	748419 ▲ FL-07300	748425 ▲ FL-09100	748431 ▲ FL-09100
	 LIMESTONE TAUPE	MATTE	748415 ◆ FL-01600	748421 ▲ FL-07300	748427 ▲ FL-09100	748433 ▲ FL-09100
	 LIMESTONE ASH	MATTE	748416 ◆ FL-01600	748422 ▲ FL-07300	748428 ▲ FL-09100	748434 ▲ FL-09100
	 LIMESTONE COAL	MATTE	748417 ◆ FL-01600	748423 ▲ FL-07300	748429 ▲ FL-09100	748435 ▲ FL-09100

PIETRE/3	scatola - box			pallet		
	pz	mq	kg	box	mq	kg
80x180	2	2,88	57,60	20	57,60	1210
60x120	2	1,44	28,08	30	43,20	870
80x80	2	1,28	24,96	40	51,20	1030
40x80	3	0,96	18,53	56	53,76	1070
60x60	3	1,08	21,06	40	43,20	870
30x60	6	1,08	20,84	40	43,20	860

PIETRE/3	scatola - box			pallet		
	pz	ml	kg	box	mq	kg
4,6x60 battiscopa	14	8,40	8,40	-	-	-

DECORO IDROGETTO

La fuga diventa decoro, la separazione della materia acquista una nuova espressività grazie alla tecnologia dell'idrogetto. Ogni realizzazione può essere unica e personalizzata in base allo spazio in cui dovrà essere inserita, il decoro può essere adattato a qualsiasi misura richiesta. Fuga tra i pezzi 1 mm. Per la realizzazione del progetto serve la pianta del cliente con indicazione precisa delle misure delle pareti da rivestire. Nel caso in cui non ci siano pareti perfettamente in squadra i pezzi ai lati saranno lasciati più lunghi di 5 cm.

Joint spaces become part of the decoration. The space that separates the material acquires a new level of expression thanks to water-jet technology. Each project can be unique and customised based on the area where it will be installed. The decoration can be adapted to any requested measurements. 1 mm joint space between tiles. The customer's floor plan is required to design the project, providing the precise measurements of the walls where the material will be applied. If the walls are not perfectly square, the side pieces must be left 5 cm longer.

Le joint devient une décoration, la séparation de la matière acquiert une nouvelle expressivité grâce à la technologie de l'hydrojet. Toutes les réalisations peuvent être uniques et personnalisées selon l'espace où elles devront être insérées, la décoration peut être adaptée à toute mesure demandée. Joint entre les pièces 1 mm. Pour la réalisation du projet, il faut le plan du client avec l'indication précise des mesures des murs à couvrir. Au cas où les murs ne seraient pas parfaitement en équerre, les pièces sur les côtés seront laissées plus longues de 5 cm.

Die Fuge wird zum Dekor; die Trennung der Materie erlangt dank der Wasserstrahltechnologie eine neue Ausdruckskraft. Jede Umsetzung kann einzigartig sein und je nach Raum, in den sie eingefügt werden soll, personalisiert werden. Das Dekor kann jeder gewünschten Größe angepasst werden. Fuge zwischen den Teilen 1 mm. Zur Umsetzung des Projekts wird der Plan des Kunden mit genauer Angabe der Maße der zu verkleidenden Wand benötigt. Im Falle von nicht perfekt quadratischen Wänden werden die an den Seiten befindlichen Teile 5 cm länger gelassen.

La junta se vuelve decoración, la separación de la materia adquiere una nueva expresión gracias a la tecnología de la propulsión por chorro de agua. Toda realización puede ser única y personalizada en base al espacio en el que se deberá colocar, la decoración se puede adaptar a cualquier medida requerida. Junta entre las piezas de 1 mm. Para llevar a cabo el proyecto es necesario contar con la planta del cliente, que indica con precisión las medidas de las paredes que hay que revestir. En el caso en el que no se cuente con paredes perfectamente en ángulo agudo, las piezas de los lados tendrán una longitud superior a los 5 cm.



Decoro Idrogetto 748436 / ■ FL-58900

Note Imballo. Tutti i singoli pezzi tagliati vengono numerati con applicazione sulla parte a vista di un pezzo di nastro isolante dove è riportato il n° del pezzo. Le scatole sono rivestite internamente di polistirolo per garantire l'integrità dei singoli pezzi. Su ogni scatola è riportato: N° dei pezzi totali - Numerazione di ciascun pezzo. Sulla paletta viene applicata una pallet card ed una busta in plastica contenente lo schema di montaggio.

Packing notes. Each individual cut piece is given a number. The piece number is shown on the exposed side of a strip of insulation tape. The boxes are padded on the inside with polystyrene to protect the individual pieces. Each box bears the following information: Total n° of pieces - Code number of each piece. The pallet comes with a pallet card and a plastic pouch containing the assembly diagram.

Remarques concernant l'emballage. Chaque pièce découpée est numérotée avec une application sur la partie visible d'un morceau de ruban isolant sur lequel figure le n° de la pièce. Les boîtes sont revêtues intérieurement de polystyrène afin de garantir l'intégrité de chaque pièce. Sur chaque boîte figurent: le nombre de pièces totales et la numérotation de chaque pièce. Une carte de la palette et un sachet en plastique contenant le schéma du montage sont appliqués sur la palette.

Verpackungshinweise. Alle geschnittenen einzelnen Teile werden nummeriert, wobei die Nummer des Teils auf der sichtbaren Seite eines Stückes Isolierband angebracht ist. Die Kartonverpackungen sind innen mit Polystyrol ausgelegt, um die Unversehrtheit der einzelnen Teile zu gewährleisten. Folgende Angaben befinden sich auf jedem Karton: Gesamtzahl der Teile Nummerierung jedes Teils. An der Palette sind eine Palettenkarte und ein Kunststoffbeutel mit dem Montageplan angebracht.

Notas sobre el embalaje. Todas las partes cortadas se enumeran colocando en la parte a la vista de la pieza una cinta adhesiva donde se reproduce el n.º de la pieza. El interior de las cajas se reviste con poliestireno para garantizar la integridad de cada una de las piezas. Sobre cada caja se reproduce: N.º de las piezas totales - Numeración de cada pieza. En la paleta se coloca una "pallet card" y una bolsa plástica que contiene el esquema del montaje.

Marble, m, marble, marble pillar,
a marble statue, a slab of marble,
a marble quarry, various marbles,
a collection of Greek marbles,
to have a heart of stone,
to freeze.



PIETRE/3 OUTDOOR

Vantaggi tecnici - Technical advantages - Avantages techniques Technische Vorteile - Ventajas técnicas

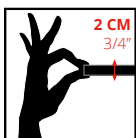

- Lastra monolitica compatta di spessore 2 cm squadrata e rettificata
- Compact monolithic slab 2 cm thick squared and rectified
- Dalle monolithique compacte de 2 cm d'épaisseur, équaree et rectifiée
- Kompakte monolithische Platte, 2 cm dick, rechteckig und scharfkantig geschliffen
- Losa monolítica compacta de 2 cm de espesor, escuadrada y rectificada.

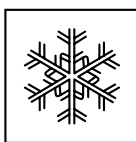

- INGELIVO
- FROST RESISTANT
- INGÉLIF
- FROSTBESTÄNDIG
- RESISTENTE A LA HELADA

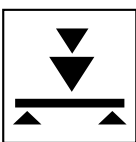

- ELEVATA RESISTENZA AI CARICHI STATICI
- HIGH STATIC LOAD RESISTANCE
- RÉSISTANCE ÉLEVÉE AUX CHARGES STATIQUES
- HOHE STATISCHE BELASTBARKEIT
- ELEVADA RESISTENCIA A LAS CARGAS ESTÁTICAS

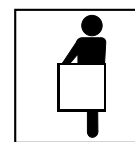

- FACILE DA POSARE
- EASY TO INSTALL
- FACILE À POSER
- VERLEGELEICHT
- FÁCIL DE COLOCAR



- ANTISCIVOLO R11
- ANTI SLIP R11
- ANTIDÉRAPANT R11
- RUTSCHFEST R11
- ANTIDESLIZANTE R11

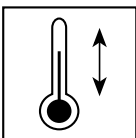

- RESISTENTE AGLI SBALZI TERMICI
- THERMAL SHOCK RESISTANT
- RÉSISTANT AUX ÉCARTS THERMIQUES
- TEMPERATURWECHSELBESTÄNDIG
- RESISTENTE A LAS OSCILACIONES TÉRMICAS



- FACILE DA PULIRE
- EASY TO CLEAN
- FACILE À NETTOYER
- REINIGUNGSLEICHT
- FÁCIL DE LIMPIAR

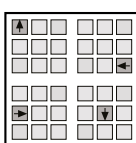

- RIMOVIBILE E RIUTILIZZABILE
- REMOVABLE AND REUSABLE
- DÉMONTABLE ET RÉUTILISABLE
- ENTFERNBAR UND WIEDERVERWENDBAR
- DESMONTABLE Y REUTILIZABLE



- INATTACCABILE DA AGENTI CHIMICI E MUFFE
- IMPERVIOUS TO ATTACK BY CHEMICALS OR MOULD
- RÉSISTANT AUX AGENTS CHIMIQUES ET AUX MOISSISSURES
- UNANGREIFBAR DURCH CHEMISCHE STOFFE UND SCHIMMEL
- RESISTENTE A LOS AGENTES QUÍMICOS Y A LOS MOHOS

Applicazioni - Applications - Applications - Verlegung - Aplicaciones

- Posa diretta su erba
- Direct installation on grass
- Pose direct sur de l'herbe
- Verlegung direkt auf Rasen
- Colocación directa sobre hierba



- Posa diretta su ghiaia
- Direct installation over gravel
- Pose direct sur du gravier
- Verlegung direkt auf Kies
- Colocación directa sobre grava



- Posa su massetto cementizio
- Installation on sand-cement screed
- Pose sur chape ciment
- Verlegung auf Zement-Unterbetonblock
- Colocación sobre contrapiso de hormigón

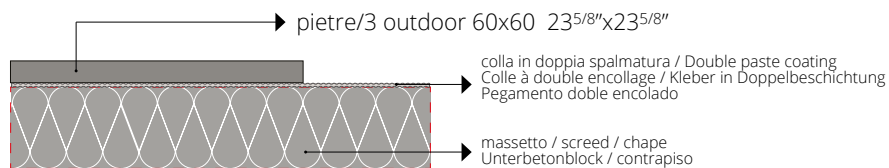

- Posa su piedini fissi o regolabili
- Installation on fixed or adjustable feet
- Pose sur pieds fixes ou réglables
- Verlegung auf feststehende oder regulierbare Füße
- Colocación sobre pies fijos o regulables

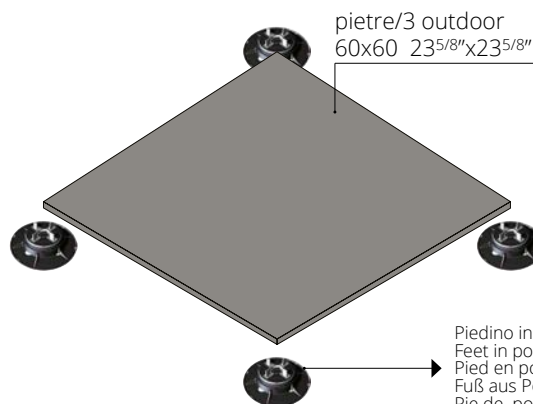

Per le specifiche di utilizzo dei sistemi sopraelevati vedi il sito florim.com
For the specifics on use of raised systems visit the site florim.com
Pour les caractéristiques d'utilisation des systèmes surélevés, voir le site florim.com
Für die Nutzungsbedingungen der Doppelbodensysteme siehe Webseite florim.com
Para las especificaciones de empleo de los sistemas sobreelevados consulte el sitio web florim.com

Le lastre ceramiche sono sottoposte a un trattamento di compattazione termica che assicura resistenza e durata nel tempo. Il bassissimo assorbimento d'acqua rende perciò il materiale ingelivo. Ciò può comportare ristagni d'acqua superficiali anche per materiale installato a regola d'arte. / Ceramic tiles undergo a compacting thermal treatment that ensures resistance and durability. The low level of water absorption makes the slabs frost resistant. This could result in superficial water stagnations even if materials are installed in a workmanlike manner. / Les carreaux de céramique subissent un traitement thermique de compactage qui assure résistance et durabilité. Le bas niveau d'absorption d'eau rend les dalles résistant au gel. Il pourrait en résulter des stagnations d'eau superficielles, même si les dalles ont été installées dans les règles de l'art. / Die Keramikplatten werden einer thermischen Verdichtung unterzogen, welche die Widerstandsfähigkeit und Langlebigkeit sichert. Die extrem niedrige Wasseraufnahme macht das Material frostsicher. Die hohe Materialdichte kann, auch bei einer perfekten Verlegung, eine längere Abtrocknungszeit von angestaumtem Wasser zur Folge haben. / Las baldosas cerámicas se someten a un tratamiento de compactación térmica que asegura resistencia y durabilidad. La baja absorción de agua hace que las baldosas resistan al hielo. Esto podría resultar en estancamientos superficiales de agua, incluso si los materiales están instalados según las reglas del arte.

LIMESTONE PEARL



LIMESTONE ALMOND

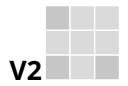

LIMESTONE ASH

R11
CLASSE C

DCOF>
0,42 Wet

20 mm 3/4" ↑↓

LIMESTONE TAUPE







LIMESTONE ASH



GRES FINE PORCELLANATO

FINE PORCELAIN STONEWARE/GRES CERAME FIN/FEINSTEINZEUG-KOLLEKTIONEN/GRES PORCELANICO FINO
SQUADRATO - SQUARED - EQUARRI - REKTIFIZIERT - ESCUADRADO

20 mm 3/4" ↑↓

	COLOR	SURFACE	60x60 23 ⁵ / ₈ "x23 ⁵ / ₈ "
PIETRE/3	 LIMESTONE PEARL	STRUTTURATO	748384 ■ FL-07700
	 LIMESTONE ALMOND	STRUTTURATO	748383 ■ FL-07700
	 LIMESTONE TAUPE	STRUTTURATO	748385 ■ FL-07700
	 LIMESTONE ASH	STRUTTURATO	748386 ■ FL-07700



PEZZI SPECIALI
Special trims/Pièces spéciales
Formstücke/Piezas especiales
pag 144/147

	RESISTENZA ALLA FLESSIONE IN N/mm ² N/mm ² FLEXURAL STRENGTH TEST / RESISTANCE A LA FLEXION EN N/mm ² / BIEGESTÄRKEIT IN N/mm ² / RESISTENCIA A LA FLEXION EN N/mm ²	valore medio 52 N/mm ²
	Forza di rottura in N (sp. > 7,5 mm) Breaking strength in N (thicknes > 7,5 mm) / Force de rupture en N (esp. > 7,5 mm) / Bruchlast in N (Dicke > 7,5 mm) / Fuerza de rotura en N (gr. > 7,5 mm)	valore medio 14000 N

PIETRE/3	scatola - box			pallet		
	pz	mq	kg	box	mq	kg
60x60 20mm	2	0,72	32,15	30	21,60	990

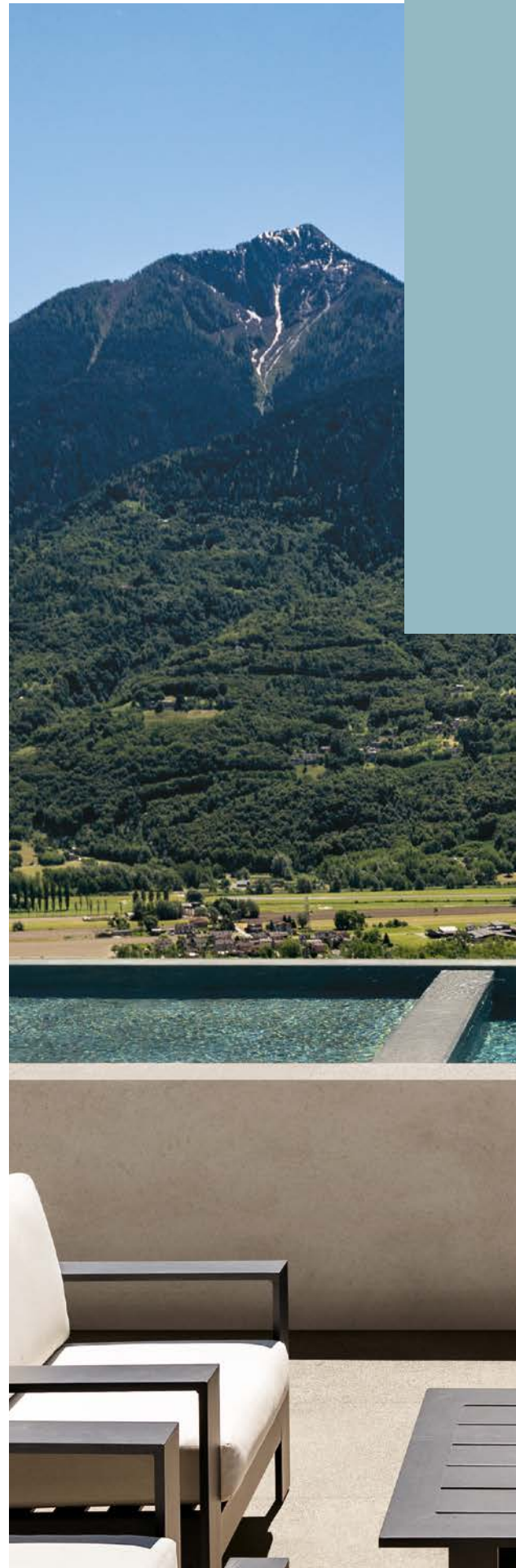

SENSI *Matteo Thun*

gres fine porcellanato
fine porcelain stoneware
grès cérame fin
feinsteinzeug-kollektionen
gres porcelánico fino





S E N S I *Matteo Thun*

“Sensi” Designed by Matteo Thun sorprende il tatto e la vista con piacevoli toni neutri per ricreare spazi fluidi. Superficie e giochi di luce definiscono un concept decorativo ispirato al non colore e alla granulosità della terra. Sensi esprime la tattilità delle terre naturali, di leggere essenze minerali che si mischiano e si forgianno nel tempo, proponendo una matericità da toccare con gli occhi. Solida, vigorosa e concreta, la terra rimanda ad un sentire personale, alla forza della natura. Con Sensi la morbidezza dei colori naturali, la sensazione tattile delle sabbie, richiamano uno stile di vita semplice, volto ad abbandonare il superfluo. L'intima e raffinata armonia della natura si rispecchia in spazi abitativi in cui godere di un comfort personale e di ritmi lenti, per ritrovare energia ed equilibrio.

“Sensi” Designed by Matteo Thun surprises visually and tactilely with attractive neutral shades that shape fluid spaces. Surfaces and interplays of light define a decorative concept inspired by non-colour and the graininess of earth. Sensi embodies the tactile experience of touching earth, and of interpreting mineral essences mixed and forged over time, in a material texture to be caressed with the eyes. Solid, vigorous and concrete, earth evokes in us a personal sentiment, reminding us of the strength of nature. With Sensi, delicate, natural colours and the tactile experience of sand recall a simple lifestyle that leaves the unnecessary behind. The intimate, sophisticated harmony of nature is reflected in living-spaces that offer an individual sense of comfort and slow rhythms, where energy and balance can be regained.

“Sensi” Designed by Matteo Thun surprend le toucher et la vue avec de superbes tonalités neutres pour donner lieu à des compositions fluides. Les surfaces et les jeux de lumière forment un concept décoratif inspiré de la « non-couleur » et de la granulosité de la terre. Sensi exprime la tactilité des terres naturelles, d'essences minérales légères qui se mélangent et se forgent au fil du temps, pour offrir un effet de matière à toucher avec les yeux. Solide, vigoureuse et concrète, la terre renvoie à un sentiment personnel, à la force de la nature. Avec Sensi, la douceur des couleurs naturelles, la sensation tactile des sables font penser à un mode de vie simple, visant à abandonner le superflu. L'harmonie intime et raffinée de la nature prend forme à travers des lieux d'habitation où profiter d'un confort personnel et de rythmes lents, pour retrouver énergie et équilibre.

“Sensi” Designed by Matteo Thun überrascht durch Haptik und Optik. Die angenehm neutralen Töne lassen fließende Räume entstehen. Oberflächen und Lichtspiele definieren ein dekoratives Konzept, das von der Nichtfarbe und der Körnigkeit der Erde inspiriert ist. Sensi bringt im Materialbild die mit den Augen fühlbare Haptik natürlicher Erden, leichter mineralischer Essenzen, die sich vermischen und mit der Zeit verschmelzen, zum Ausdruck. Beständig, kraftvoll und konkret verweist die Erde auf ein persönliches Empfinden, auf die Kraft der Natur. Mit Sensi erinnern die natürlich weichen Farben und die Haptik des Sandes an einen einfachen Lebensstil ohne Ballast. Die vertraute und verinnerlichte Harmonie der Natur spiegelt sich in Wohnräumen wider, die individuelles Wohlbefinden und langsame Rhythmen vermitteln, um wieder Energie und Gleichgewicht zu finden.

“Sensi” Designed by Matteo Thun sorprende al tacto y la vista con agradables tonos neutros para recrear espacios fluidos. Superficies y juegos de luz definen un concepto decorativo inspirado en el “no color” y en la granulosidad de la tierra. Sensi expresa el tacto de las tierras naturales, de ligeros elementos minerales que se mezclan y se forjan con el paso del tiempo, proponiendo una materialidad que tocar con la mirada. Sólida, vigorosa y concreta, la tierra remite a un sentir personal, a la fuerza de la naturaleza. Con Sensi la suavidad de los colores naturales y la sensación táctil de la arena evocan un estilo de vida sencillo, orientado a abandonar lo superfluo. La armonía íntima y refinada de la naturaleza se refleja en espacios habitables en los que disfrutar de un confort personal y de ritmos lentos, para recobrar energías y equilibrio.

DUST WHITE



LITHOS WHITE

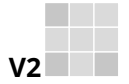

V2
R9
(dust matte)

R10
CLASSE B
(lithos
bocciardato/
matte)

DCOF>
0,42 Wet

9 mm 3/8" ↑↓

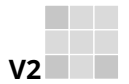

V2
R9
(dust matte)

R10
CLASSE B
(lithos
bocciardato/
matte)





DCOF>
0,42 Wet

6 mm 1/4" ↑↓

FLOHM OVERSIZE
magnUm

GRES FINE PORCELLANATO

FINE PORCELAIN STONEWARE/GRES CERAME FIN/FEINSTEINZEUG-KOLLEKTIONEN/GRES PORCELANICO FINO
SQUADRATO - SQUARED - EQUARRI - REKTIFIZIERT - ESCUADRADO

9 mm 3/8" ↑↓		COLOR	SURFACE	60x120 23 ^{5/8"} x47 ^{1/4"}	80x80 31 ^{1/2"} x31 ^{1/2"}	40x80 15 ^{3/4"} x31 ^{1/2"}	
S E N S I <i>Matteo Thun</i>		DUST WHITE	MATTE	768290 ■ FL-09900	768356 ■ FL-09300	768329 ■ FL-07300	
		LITHOS WHITE	BOCCIARDATO MATTE	768292 ■ FL-09900	768358 ■ FL-09300	768331 ■ FL-07300	
6 mm 1/4" ↑↓		COLOR	SURFACE	120x280 47 ^{1/4"} x110 ^{1/4"}	120x240 47 ^{1/4"} x94 ^{1/2"}	120x120 47 ^{1/4"} x47 ^{1/4"}	60x120 23 ^{5/8"} x47 ^{1/4"}
S E N S I <i>Matteo Thun</i>		DUST WHITE	MATTE	768601 ■ FL-12400	768576 ■ FL-11300	768551 ■ FL-09700	768616 ■ FL-09100
		LITHOS WHITE	BOCCIARDATO MATTE	768611 ■ FL-12400	768596 ■ FL-11300	768571 ■ FL-09700	768636 ■ FL-09100

SAND WHITE

FOSSIL WHITE

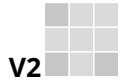

V2

R11
CLASSE C
(sand matte)

R9
(fossil matte)

R10
(fossil R+PTV)

DCOF>
0,42 Wet

9 mm 3/8" ↑↓

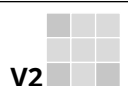

V2

R9
(matte)

R10
(sand R+PTV)

DCOF>
0,42 Wet

BS EN 16165
ANNEX C
>36 wet
slider 4S
(R+PTV)

6 mm 1/4" ↑↓



GRES FINE PORCELLANATO
FINE PORCELAIN STONEWARE/GRES CERAME FIN/FEINSTEINZEUG-KOLLEKTIONEN/GRES PORCELANICO FINO
SQUADRATO - SQUARED - EQUARRI - REKTIFIZIERT - ESCUADRADO

9 mm 3/8" ↑↓		COLOR	SURFACE	60x120 23 ^{5/8"} x47 ^{1/4"}	80x80 31 ^{1/2"} x31 ^{1/2"}	40x80 15 ^{3/4"} x31 ^{1/2"}
SENSI <i>Matte Touch</i>		SAND WHITE	MATTE	768291 ■ FL-09900	768357 ■ FL-09300	768330 ■ FL-07300
		FOSSIL WHITE	MATTE	768293 ■ FL-09900	768359 ■ FL-09300	768332 ■ FL-07300
			R+PTV	768294 ■ FL-09900	768360 ■ FL-09300	768333 ■ FL-07300

6 mm 1/4" ↑↓		COLOR	SURFACE	120x280 47 ^{1/4"} x110 ^{1/4"}	120x240 47 ^{1/4"} x94 ^{1/2"}	120x120 47 ^{1/4"} x47 ^{1/4"}	60x120 23 ^{5/8"} x47 ^{1/4"}
SENSI <i>Matte Touch</i>		SAND WHITE	MATTE	-	768591 ■ FL-11300	768566 ■ FL-09700	768631 ■ FL-09100
			R+PTV	-	768586 ■ FL-11300	768561 ■ FL-09700	768626 ■ FL-09100
		FOSSIL WHITE	MATTE	768602 ■ FL-12400	768577 ■ FL-11300	768552 ■ FL-09700	768617 ■ FL-09100

DUST IVORY



LITHOS IVORY

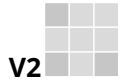

V2

R9
(dust matte)

R10
CLASSE B
(lithos
boccardato/
matte)

DCOF>
0,42 Wet

9 mm 3/8" ↑↓

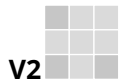

V2

R9
(dust matte)

R10
CLASSE B
(lithos
boccardato/
matte)

DCOF>
0,42 Wet

6 mm 1/4" ↑↓

FLOHM OVERSIZE
magnUm

GRES FINE PORCELLANATO
FINE PORCELAIN STONEWARE/GRES CERAME FIN/FEINSTEINZEUG-KOLLEKTIONEN/GRES PORCELANICO FINO
SQUADRATO - SQUARED - EQUARRI - REKTIFIZIERT - ESCUADRADO

9 mm 3/8" ↑↓		COLOR	SURFACE	60x120 23 ^{5/8"} x47 ^{1/4"}	80x80 31 ^{1/2"} x31 ^{1/2"}	40x80 15 ^{3/4"} x31 ^{1/2"}	
S E N S I <i>Matteo Thun</i>		DUST IVORY	MATTE	768295 ■ FL-09900	768361 ■ FL-09300	768334 ■ FL-07300	
		LITHOS IVORY	BOCCIARDATO MATTE	768297 ■ FL-09900	768363 ■ FL-09300	768336 ■ FL-07300	
6 mm 1/4" ↑↓		COLOR	SURFACE	120x280 47 ^{1/4"} x110 ^{1/4"}	120x240 47 ^{1/4"} x94 ^{1/2"}	120x120 47 ^{1/4"} x47 ^{1/4"}	60x120 23 ^{5/8"} x47 ^{1/4"}
S E N S I <i>Matteo Thun</i>		DUST IVORY	MATTE	768603 ■ FL-12400	768578 ■ FL-11300	768553 ■ FL-09700	768618 ■ FL-09100
		LITHOS IVORY	BOCCIARDATO MATTE	768612 ■ FL-12400	768597 ■ FL-11300	768572 ■ FL-09700	768637 ■ FL-09100

SAND IVORY



FOSSIL IVORY

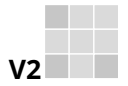

V2

R11
CLASSE C
(sand matte)

R9
(fossil matte)

R10
(fossil R+PTV)

DCOF>
0,42 Wet

9 mm 3/8" ↑↓

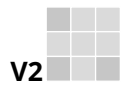

V2

R9
(matte)

R10
(sand R+PTV)

DCOF>
0,42 Wet

BS EN 16165
ANNEX C
>36 wet
slider 4S
(R+PTV)

6 mm 1/4" ↑↓

FLORM OVERSIZE
magnUm

GRES FINE PORCELLANATO
FINE PORCELAIN STONEWARE/GRES CERAME FIN/FEINSTEINZEUG-KOLLEKTIONEN/GRES PORCELANICO FINO
SQUADRATO - SQUARED - EQUARRI - REKTIFIZIERT - ESCUADRADO

9 mm 3/8" ↑↓	COLOR	SURFACE	60x120 23 ^{5/8"} x47 ^{1/4"}	80x80 31 ^{1/2"} x31 ^{1/2"}	40x80 15 ^{3/4"} x31 ^{1/2"}
SENSI <i>Matte Three</i>		SAND IVORY	768296 ■ FL-09900	768362 ■ FL-09300	768335 ■ FL-07300
		FOSSIL IVORY	768298 ■ FL-09900	768364 ■ FL-09300	768337 ■ FL-07300
		R+PTV	768299 ■ FL-09900	768365 ■ FL-09300	768338 ■ FL-07300

6 mm 1/4" ↑↓	COLOR	SURFACE	120x280 47 ^{1/4"} x110 ^{1/4"}	120x240 47 ^{1/4"} x94 ^{1/2"}	120x120 47 ^{1/4"} x47 ^{1/4"}	60x120 23 ^{5/8"} x47 ^{1/4"}
SENSI <i>Matte Three</i>		SAND IVORY	-	768592 ■ FL-11300	768567 ■ FL-09700	768632 ■ FL-09100
		R+PTV	-	768587 ■ FL-11300	768562 ■ FL-09700	768627 ■ FL-09100
		FOSSIL IVORY	768604 ■ FL-12400	768579 ■ FL-11300	768554 ■ FL-09700	768619 ■ FL-09100

DUST GREY



LITHOS GREY

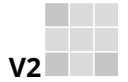

V2

R9
(dust matte)

R10
CLASSE B
(lithos
bocciardato/
matte)

DCOF>
0,42 Wet

9 mm 3/8" ↑↓

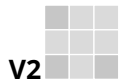

V2

R9
(dust matte)

R10
CLASSE B
(lithos
bocciardato/
matte)

DCOF>
0,42 Wet

6 mm 1/4" ↑↓

FLOHM OVERSIZE
magnuM

GRES FINE PORCELLANATO
FINE PORCELAIN STONEWARE/GRES CERAME FIN/FEINSTEINZEUG-KOLLEKTIONEN/GRES PORCELANICO FINO
SQUADRATO - SQUARED - EQUARRI - REKTIFIZIERT - ESCUADRADO

9 mm 3/8" ↑↓		COLOR	SURFACE	60x120 23 ^{5/8"} x47 ^{1/4"}	80x80 31 ^{1/2"} x31 ^{1/2"}	40x80 15 ^{3/4"} x31 ^{1/2"}	
S E N S I <i>Matteo Thun</i>		DUST GREY	MATTE	768300 ■ FL-09900	768366 ■ FL-09300	768339 ■ FL-07300	
		LITHOS GREY	BOCCIARDATO MATTE	768315 ■ FL-09900	768368 ■ FL-09300	768341 ■ FL-07300	
6 mm 1/4" ↑↓		COLOR	SURFACE	120x280 47 ^{1/4"} x110 ^{1/4"}	120x240 47 ^{1/4"} x94 ^{1/2"}	120x120 47 ^{1/4"} x47 ^{1/4"}	60x120 23 ^{5/8"} x47 ^{1/4"}
S E N S I <i>Matteo Thun</i>		DUST GREY	MATTE	768605 ■ FL-12400	768580 ■ FL-11300	768555 ■ FL-09700	768620 ■ FL-09100
		LITHOS GREY	BOCCIARDATO MATTE	768613 ■ FL-12400	768598 ■ FL-11300	768573 ■ FL-09700	768638 ■ FL-09100

SAND GREY



FOSSIL GREY

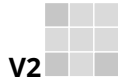

V2

R11
CLASSE C
(sand matte)

R9
(fossil matte)

R10
(fossil R+PTV)

DCOF>
0,42 Wet

9 mm 3/8" ↑↓

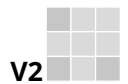

V2

R9
(matte)

R10
(sand R+PTV)

DCOF>
0,42 Wet

BS EN 16165
ANNEX C
>36 wet
slider 4S
(R+PTV)

6 mm 1/4" ↑↓

FLOHM OVERSIZE
magnUm

GRES FINE PORCELLANATO

FINE PORCELAIN STONEWARE/GRES CERAME FIN/FEINSTEINZEUG-KOLLEKTIONEN/GRES PORCELANICO FINO
SQUADRATO - SQUARED - EQUARRI - REKTIFIZIERT - ESCUADRADO

9 mm 3/8" ↑↓		COLOR	SURFACE	60x120 23 ^{5/8"} x47 ^{1/4"}	80x80 31 ^{1/2"} x31 ^{1/2"}	40x80 15 ^{3/4"} x31 ^{1/2"}
S E N S I <i>Matte Thin</i>		SAND GREY	MATTE	768312 ■ FL-09900	768367 ■ FL-09300	768340 ■ FL-07300
		FOSSIL GREY	MATTE	768316 ■ FL-09900	768370 ■ FL-09300	768342 ■ FL-07300
			R+PTV	768317 ■ FL-09900	768369 ■ FL-09300	768343 ■ FL-07300

6 mm 1/4" ↑↓		COLOR	SURFACE	120x280 47 ^{1/4"} x110 ^{1/4"}	120x240 47 ^{1/4"} x94 ^{1/2"}	120x120 47 ^{1/4"} x47 ^{1/4"}	60x120 23 ^{5/8"} x47 ^{1/4"}
S E N S I <i>Matte Thin</i>		SAND GREY	MATTE	-	768593 ■ FL-11300	768568 ■ FL-09700	768633 ■ FL-09100
			R+PTV	-	768588 ■ FL-11300	768563 ■ FL-09700	768628 ■ FL-09100
		FOSSIL GREY	MATTE	768606 ■ FL-12400	768581 ■ FL-11300	768556 ■ FL-09700	768621 ■ FL-09100

DUST TAUPE



LITHOS TAUPE

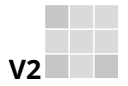

V2
R9
(dust matte)

R10
CLASSE B
(lithos boccardato/
matte)

DCOF>
0,42 Wet

9 mm 3/8" ↑↓

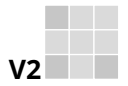

V2
R9
(dust matte)



R10
CLASSE B
(lithos boccardato/
matte)



DCOF>
0,42 Wet

6 mm 1/4" ↑↓

FLOHM OVERSIZE
magnUm

GRES FINE PORCELLANATO
FINE PORCELAIN STONEWARE/GRES CERAME FIN/FEINSTEINZEUG-KOLLEKTIONEN/GRES PORCELANICO FINO
SQUADRATO - SQUARED - EQUARRI - REKTIFIZIERT - ESCUADRADO

9 mm 3/8" ↑↓	COLOR	SURFACE	60x120 23 ^{5/8"} x47 ^{1/4"}	80x80 31 ^{1/2"} x31 ^{1/2"}	40x80 15 ^{3/4"} x31 ^{1/2"}	
S E N S I <i>Matteo Thun</i>		DUST TAUPE	MATTE	768318 ■ FL-09900	768371 ■ FL-09300	768344 ■ FL-07300
		LITHOS TAUPE	BOCCIARDATO MATTE	768321 ■ FL-09900	768373 ■ FL-09300	768346 ■ FL-07300

6 mm 1/4" ↑↓	COLOR	SURFACE	120x280 47 ^{1/4"} x110 ^{1/4"}	120x240 47 ^{1/4"} x94 ^{1/2"}	120x120 47 ^{1/4"} x47 ^{1/4"}	60x120 23 ^{5/8"} x47 ^{1/4"}	
S E N S I <i>Matteo Thun</i>		DUST TAUPE	MATTE	768607 ■ FL-12400	768582 ■ FL-11300	768557 ■ FL-09700	768622 ■ FL-09100
		LITHOS TAUPE	BOCCIARDATO MATTE	768614 ■ FL-12400	768599 ■ FL-11300	768574 ■ FL-09700	768639 ■ FL-09100

SAND TAUPE

FOSSIL TAUPE

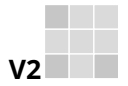

V2

R11
CLASSE C
(sand matte)

R9
(fossil matte)

R10
(fossil R+PTV)

DCOF>
0,42 Wet

9 mm 3/8" ↑↓

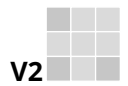

V2

R9
(matte)

R10
(sand R+PTV)

DCOF>
0,42 Wet

BS EN 16165
ANNEX C
>36 wet
slider 4S
(R+PTV)

6 mm 1/4" ↑↓

FLORM OVERSIZE
magnUm

GRES FINE PORCELLANATO
FINE PORCELAIN STONEWARE/GRES CERAME FIN/FEINSTEINZEUG-KOLLEKTIONEN/GRES PORCELANICO FINO
SQUADRATO - SQUARED - EQUARRI - REKTIFIZIERT - ESCUADRADO

9 mm 3/8" ↑↓		COLOR	SURFACE	60x120 23 ^{5/8"} x47 ^{1/4"}	80x80 31 ^{1/2"} x31 ^{1/2"}	40x80 15 ^{3/4"} x31 ^{1/2"}
S E N S I <i>Matte Thin</i>		SAND TAUPE	MATTE	768319 ■ FL-09900	768372 ■ FL-09300	768345 ■ FL-07300
		FOSSIL TAUPE	MATTE	768322 ■ FL-09900	768374 ■ FL-09300	768347 ■ FL-07300
			R+PTV	768323 ■ FL-09900	768375 ■ FL-09300	768348 ■ FL-07300

6 mm 1/4" ↑↓		COLOR	SURFACE	120x280 47 ^{1/4"} x110 ^{1/4"}	120x240 47 ^{1/4"} x94 ^{1/2"}	120x120 47 ^{1/4"} x47 ^{1/4"}	60x120 23 ^{5/8"} x47 ^{1/4"}
S E N S I <i>Matte Thin</i>		SAND TAUPE	MATTE	-	768594 ■ FL-11300	768569 ■ FL-09700	768634 ■ FL-09100
			R+PTV	-	768589 ■ FL-11300	768564 ■ FL-09700	768629 ■ FL-09100
		FOSSIL TAUPE	MATTE	768608 ■ FL-12400	768583 ■ FL-11300	768558 ■ FL-09700	768623 ■ FL-09100

DUST BROWN



LITHOS BROWN

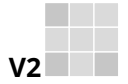

V2
R9
(dust matte)

R10
CLASSE B
(lithos
bocciardato/
matte)

DCOF>
0,42 Wet

9 mm 3/8" ↑↓

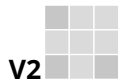

V2
R9
(dust matte)



R10
CLASSE B
(lithos
bocciardato/
matte)



DCOF>
0,42 Wet

6 mm 1/4" ↑↓

FLOHM OVERSIZE
magnuM

GRES FINE PORCELLANATO
FINE PORCELAIN STONEWARE/GRES CERAME FIN/FEINSTEINZEUG-KOLLEKTIONEN/GRES PORCELANICO FINO
SQUADRATO - SQUARED - EQUARRI - REKTIFIZIERT - ESCUADRADO

9 mm 3/8" ↑↓	COLOR	SURFACE	60x120 23 ^{3/8"} x47 ^{1/4"}	80x80 31 ^{1/2"} x31 ^{1/2"}	40x80 15 ^{3/4"} x31 ^{1/2"}
S E N S I <i>Matteo Thun</i>	 DUST BROWN	MATTE	768324 ■ FL-09900	768376 ■ FL-09300	768349 ■ FL-07300
	 LITHOS BROWN	BOCCIARDATO MATTE	768326 ■ FL-09900	768378 ■ FL-09300	768352 ■ FL-07300

6 mm 1/4" ↑↓	COLOR	SURFACE	120x280 47 ^{1/4"} x110 ^{1/4"}	120x240 47 ^{1/4"} x94 ^{1/2"}	120x120 47 ^{1/4"} x47 ^{1/4"}	60x120 23 ^{5/8"} x47 ^{1/4"}
S E N S I <i>Matteo Thun</i>	 DUST BROWN	MATTE	768609 ■ FL-12400	768584 ■ FL-11300	768559 ■ FL-09700	768624 ■ FL-09100
	 LITHOS BROWN	BOCCIARDATO MATTE	768615 ■ FL-12400	768600 ■ FL-11300	768575 ■ FL-09700	768640 ■ FL-09100

SAND BROWN

FOSSIL BROWN

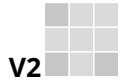

V2

R11
CLASSE C
(sand matte)

R9
(fossil matte)

R10
(fossil R+PTV)

DCOF>
0,42 Wet

9 mm 3/8" ↑↓



V2

R9
(matte)

R10
(sand R+PTV)

DCOF>
0,42 Wet

BS EN 16165
ANNEX C
>36 wet
slider 4S
(R+PTV)

6 mm 1/4" ↑↓











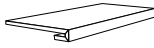
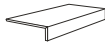









FLORM OVERSIZE
magnUm

GRES FINE PORCELLANATO
FINE PORCELAIN STONEWARE/GRES CERAME FIN/FEINSTEINZEUG-KOLLEKTIONEN/GRES PORCELANICO FINO
SQUADRATO - SQUARED - EQUARRI - REKTIFIZIERT - ESCUADRADO

9 mm 3/8" ↑↓		COLOR	SURFACE	60x120 23 ^{3/8"} x47 ^{1/4"}	80x80 31 ^{1/2"} x31 ^{1/2"}	40x80 15 ^{3/4"} x31 ^{1/2"}
S E N S I <i>Matte Thin</i>		SAND BROWN	MATTE	768325 ■ FL-09900	768377 ■ FL-09300	768350 ■ FL-07300
		FOSSIL BROWN	MATTE	768327 ■ FL-09900	768379 ■ FL-09300	768353 ■ FL-07300
			R+PTV	768328 ■ FL-09900	768380 ■ FL-09300	768354 ■ FL-07300

6 mm 1/4" ↑↓		COLOR	SURFACE	120x280 47 ^{1/4"} x110 ^{1/4"}	120x240 47 ^{1/4"} x94 ^{1/2"}	120x120 47 ^{1/4"} x47 ^{1/4"}	60x120 23 ^{5/8"} x47 ^{1/4"}
S E N S I <i>Matte Thin</i>		SAND BROWN	MATTE	-	768595 ■ FL-11300	768570 ■ FL-09700	768635 ■ FL-09100
			R+PTV	-	768590 ■ FL-11300	768565 ■ FL-09700	768630 ■ FL-09100
		FOSSIL BROWN	MATTE	768610 ■ FL-12400	768585 ■ FL-11300	768560 ■ FL-09700	768625 ■ FL-09100

PEZZI SPECIALI/SPECIAL TRIMS/PIÈCES SPÉCIALES/FORMSTÜCKE/PIEZAS ESPECIALES

9 mm 3/8" ↑↓	COLOR	SURFACE	4,6x60 1 4/5" x 23 5/8"  battiscopa	33x120x3 13" x 47 1/4" x 1 1/8"  gradino pz/box 2	20x40x6 7 7/8" x 15 3/4" x 2 1/3"  elemento elle pz/box 4	6 mm 1/4" ↑↓
	DUST WHITE	MATTE	770937 ◆ FL-01600	770976 ▲ FL-20400	770996 ▲ FL-02700	771016 ◆ FL-01800
	LITHOS WHITE	BOCCIARDATO MATTE	770957 ◆ FL-01600	770977 ▲ FL-20400	770997 ▲ FL-02700	771017 ◆ FL-01800
	SAND WHITE	MATTE	770958 ◆ FL-01600	770978 ▲ FL-20400	770998 ▲ FL-02700	771018 ◆ FL-01800
	FOSSIL WHITE	MATTE	770959 ◆ FL-01600	770979 ▲ FL-20400	770999 ▲ FL-02700	771019 ◆ GR-01070
	DUST IVORY	MATTE	770960 ◆ FL-01600	770980 ▲ FL-20400	771000 ▲ FL-02700	771020 ◆ FL-01800
	LITHOS IVORY	BOCCIARDATO MATTE	770961 ◆ FL-01600	770981 ▲ FL-20400	771001 ▲ FL-02700	771021 ◆ FL-01800
	SAND IVORY	MATTE	770962 ◆ FL-01600	770982 ▲ FL-20400	771002 ▲ FL-02700	771022 ◆ GR-01070
	FOSSIL IVORY	MATTE	770963 ◆ FL-01600	770983 ▲ FL-20400	771003 ▲ FL-02700	771023 ◆ FL-01800
	DUST GREY	MATTE	770964 ◆ FL-01600	770984 ▲ FL-20400	771004 ▲ FL-02700	771024 ◆ FL-01800
	LITHOS GREY	BOCCIARDATO MATTE	770965 ◆ FL-01600	770985 ▲ FL-20400	771005 ▲ GR-01240	771025 ◆ FL-01800
	SAND GREY	MATTE	770966 ◆ FL-01600	770986 ▲ FL-20400	771006 ▲ FL-02700	771026 ◆ FL-01800
	FOSSIL GREY	MATTE	770967 ◆ FL-01600	770987 ▲ FL-20400	771007 ▲ FL-02700	771027 ◆ FL-01800
	DUST TAUPE	MATTE	770968 ◆ FL-01600	770988 ▲ FL-20400	771008 ▲ FL-02700	771028 ◆ FL-01800
	LITHOS TAUPE	BOCCIARDATO MATTE	770969 ◆ FL-01600	770989 ▲ FL-20400	771009 ▲ FL-02700	771029 ◆ FL-01800
	SAND TAUPE	MATTE	770970 ◆ FL-01600	770990 ▲ FL-20400	771010 ▲ FL-02700	771030 ◆ FL-01800
	FOSSIL TAUPE	MATTE	770971 ◆ FL-01600	770991 ▲ FL-20400	771011 ▲ FL-02700	771031 ◆ FL-01800
	DUST BROWN	MATTE	770972 ◆ FL-01600	770992 ▲ FL-20400	771012 ▲ FL-02700	771032 ◆ FL-01800
	LITHOS BROWN	BOCCIARDATO MATTE	770973 ◆ FL-01600	770993 ▲ FL-20400	771013 ▲ FL-02700	771033 ◆ FL-01800
	SAND BROWN	MATTE	770974 ◆ FL-01600	770994 ▲ FL-20400	771014 ▲ FL-02700	771034 ◆ FL-01800
	FOSSIL BROWN	MATTE	770975 ◆ FL-01600	770995 ▲ FL-20400	771015 ▲ FL-02700	771035 ◆ FL-01800

SENSI
Matteo Thun



Esempio di personalizzazione decoro in dimensione 120x240

Example of customised décor, size 120x240 / Voici un exemple de personnalisation du décor en format 120x240
 Beispiel für die Personalisierung des Dekors bei Format 120x240 / Ejemplo de personalización de decoración en tamaño 120x240



1 /sand grey
 2 /lithos grey

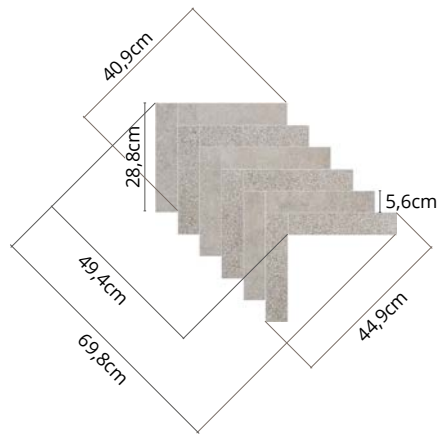

CDCST / 771227 - 6mm ■ FL-26800
 CDCST / 771231 - 9mm ■ FL-23600

S E N S I <i>Matta Tinta</i>	scatola - box			pallet		
	pz	mq	kg	box	mq	kg
CDCST 6mm	6	1,21	17,52	16	19,36	310
CDCST 9mm	4	0,81	11,73	16	12,96	210

Per questo decoro è possibile selezionare colori e superfici combinandoli nel modo in cui si desidera (vedi esempio).
 Colours and surfaces can be selected in any desired combination for this decor (see example).
 Pour ce décor il est possible de sélectionner des couleurs et des surfaces en les combinant comme vous le souhaitez (voir l'exemple).
 Bei diesem Dekor können Farben und Oberflächen frei ausgewählt und nach Wunsch kombiniert werden (siehe Beispiel).
 Para esta decoración es posible seleccionar colores y superficies combinándolos de la forma que desee (ver ejemplo).

Vantaggi tecnici - Technical advantages - Avantages techniques
Technische Vorteile - Ventajas técnicas

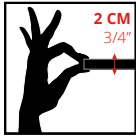

- Lastra monolitica compatta di spessore 2 cm squadrata e rettificata
- Compact monolithic slab 2 cm thick squared and rectified
- Dalle monolithique compacte de 2 cm d'épaisseur, équerrie et rectifiée
- Kompakte monolithische Platte, 2 cm dick, rechteckig und scharfkantig geschliffen
- Losa monolítica compacta de 2 cm de espesor, escuadrada y rectificada.

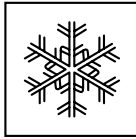

- INGELIVO
- FROST RESISTANT
- INGÉLIF
- FROSTBESTÄNDIG
- RESISTENTE A LA HELADA

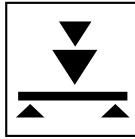

- ELEVATA RESISTENZA AI CARICHI STATICI
- HIGH STATIC LOAD RESISTANCE
- RÉSISTANCE ÉLEVÉE AUX CHARGES STATIQUES
- HOHE STATISCHE BELASTBARKEIT
- ELEVADA RESISTENCIA A LAS CARGAS ESTÁTICAS

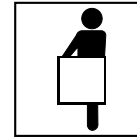

- FACILE DA POSARE
- EASY TO INSTALL
- FACILE À POSER
- VERLEGELEICHT
- FÁCIL DE COLOCAR



- ANTISCIVOLO R11
- ANTI SLIP R11
- ANTIDÉRAPANT R11
- RUTSCHFEST R11
- ANTIDESLIZANTE R11

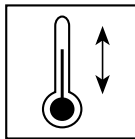

- RESISTENTE AGLI SBALZI TERMICI
- THERMAL SHOCK RESISTANT
- RÉSISTANT AUX ÉCARTS THERMIQUES
- TEMPERATURWECHSELBESTÄNDIG
- RESISTENTE A LAS OSCILACIONES TÉRMICAS



- FACILE DA PULIRE
- EASY TO CLEAN
- FACILE À NETTOYER
- REINIGUNGSLEICHT
- FÁCIL DE LIMPIAR

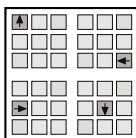

- RIMOVIBILE E RIUTILIZZABILE
- REMOVABLE AND REUSABLE
- DÉMONTABLE ET RÉUTILISABLE
- ENTFERNBAR UND WIEDERVERWENDBAR
- DESMONTABLE Y REUTILIZABLE



- INATTACCABILE DA AGENTI CHIMICI E MUFFE
- IMPERVIOUS TO ATTACK BY CHEMICALS OR MOULD
- RÉSISTANT AUX AGENTS CHIMIQUES ET AUX MOISSISSURES
- UNANGREIFBAR DURCH CHEMISCHE STOFFE UND SCHIMMEL
- RESISTENTE A LOS AGENTES QUÍMICOS Y A LOS MOHOS

Applicazioni - Applications - Applications - Verlegung - Aplicaciones

- Posa diretta su erba
- Direct installation on grass
- Pose direct sur de l'herbe
- Verlegung direkt auf Rasen
- Colocación directa sobre hierba

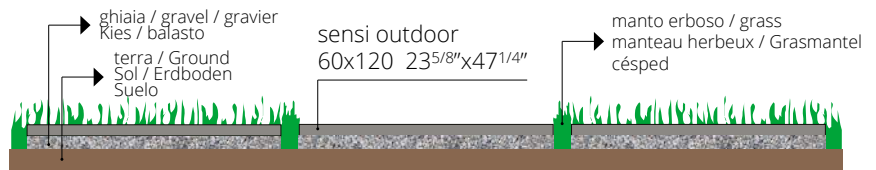

- Posa diretta su ghiaia
- Direct installation over gravel
- Pose direct sur du gravier
- Verlegung direkt auf Kies
- Colocación directa sobre grava

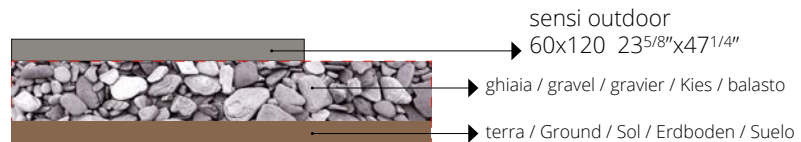

- Posa su massetto cementizio
- Installation on sand-cement screed
- Pose sur chape ciment
- Verlegung auf Zement-Unterbetonblock
- Colocación sobre contrapiso de hormigón

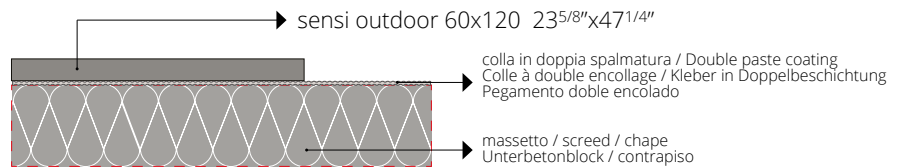

- Posa su piedini fissi o regolabili
- Installation on fixed or adjustable feet
- Pose sur pieds fixes ou réglables
- Verlegung auf feststehende oder regulierbare Füße
- Colocación sobre pies fijos o regulables

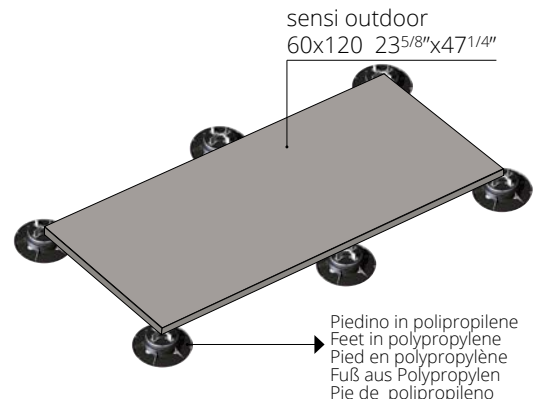

Per le specifiche di utilizzo dei sistemi sopraelevati vedi il sito florim.com
For the specifics on use of raised systems visit the site florim.com
Pour les caractéristiques d'utilisation des systèmes surélevés, voir le site florim.com
Für die Nutzungsbedingungen der Doppelbodensysteme siehe Webseite florim.com
Para las especificaciones de empleo de los sistemas sobreelevados consulte el sitio web florim.com

Le lastre ceramiche sono sottoposte a un trattamento di compattazione termica che assicura resistenza e durata nel tempo. Il bassissimo assorbimento d'acqua rende perciò il materiale ingelivo. Ciò può comportare ristagni d'acqua superficiali anche per materiale installato a regola d'arte. / Ceramic tiles undergo a compacting thermal treatment that ensures resistance and durability. The low level of water absorption makes the slabs frost resistant. This could result in superficial water stagnations even if materials are installed in a workmanlike manner. / Les carreaux de céramique subissent un traitement thermique de compactage qui assure résistance et durabilité. Le bas niveau d'absorption d'eau rend les dalles résistant au gel. Il pourrait en résulter des stagnations d'eau superficielles, même si les dalles ont été installées dans les règles de l'art. / Die Keramikplatten werden einer thermischen Verdichtung unterzogen, welche die Widerstandsfähigkeit und Langlebigkeit sichert. Die extrem niedrige Wasseraufnahme macht das Material frostresistent. Die hohe Materialdichte kann, auch bei einer perfekten Verlegung, eine längere Abtrochnungszeit von angestaumtem Wasser zur Folge haben. / Las baldosas cerámicas se someten a un tratamiento de compactación térmica que asegura resistencia y durabilidad. La baja absorción de agua hace que las baldosas resistan al hielo. Esto podría resultar en estancamientos superficiales de agua, incluso si los materiales están instalados según las reglas del arte.

SAND WHITE



SAND IVORY

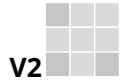

R11
(strutturato)
CLASSE C

DCOF >
0,42 Wet

20 mm 3/4" ↑↓

SAND GREY



SAND TAUPE



SAND BROWN



GRES FINE PORCELLANATO

FINE PORCELAIN STONEWARE/GRES CERAME FIN/FEINSTEINZEUG-KOLLEKTIONEN/GRES PORCELANICO FINO
SQUADRATO - SQUARED - EQUARRI - REKTIFIZIERT - ESCUADRADO

20 mm 3/4" ↑↓	COLOR	SURFACE	60x120 23 5/8" x 47 1/4"
	SAND WHITE	STRUTTURATO	768393 ■ FL-11300
	SAND IVORY	STRUTTURATO	768394 ■ FL-11300
	SAND GREY	STRUTTURATO	768395 ■ FL-11300
	SAND TAUPE	STRUTTURATO	768396 ■ FL-11300
	SAND BROWN	STRUTTURATO	768397 ■ FL-11300

S E N S I
Matte Finish



ISO 10545-4	RESISTENZA ALLA FLESSIONE IN N/mm ² N/mm ² FLEXURAL STRENGTH TEST / RESISTANCE A LA FLEXION EN N/mm ² / BIEGEFESTIGKEIT IN N/mm ² / RESISTENCIA A LA FLEXION EN N/mm ²	valore medio 52 N/mm ²
	Forza di rottura in N (sp. > 7,5 mm) Breaking strength in N (thickness > 7,5 mm) / Force de rupture en N (ép. > 7,5 mm) / Bruchlast in N (Dicke > 7,5 mm) / Fuerza de rotura en N (g. > 7,5 mm)	valore medio 14000 N

PEZZI SPECIALI

Special trims/Pièces spéciales
Formstücke/Piezas especiales
pag 144/145

S E N S I <i>Matte Finish</i>	scatola - box			pallet		
	pz	mq	kg	box	mq	kg
60x120 20mm	1	0,72	32,30	30	21,60	1000



STONES&MORE 2.0

gres fine porcellanato
fine porcelain stoneware
grès cérame fin
feinsteinzeug-kollektionen
gres porcelánico fino





STONES&MORE 2.0

Una raffinata selezione di pietre e marmi, un immaginario viaggio fra le suggestioni di luoghi diversi per raccogliere 9 fonti ispirative dal perfetto equilibrio cromatico. Forme essenziali e accostamenti vintage raccontano una storia attraverso superfici profondamente diverse in cui il filo conduttore è la stessa filosofia di eleganza.

A fine selection of stones and marbles, an imaginary journey through a variety of evocative landscapes to collect 9 sources of inspiration in a perfectly balanced colour range. Essential shapes and vintage combinations are express through radically different surfaces linked together from the same philosophy of elegance.

Une sélection raffinée de pierres et de marbres, un voyage imaginaire parmi les suggestions de lieux différents pour recueillir 9 sources d'inspiration à l'équilibre chromatique parfait. Formes essentielles et approches vintage racontent une histoire à travers des surfaces profondément différentes dont le fil conducteur repose sur la même philosophie d'élégance.

Die raffinierte Auswahl an Stein und Marmor ist Frucht einer imaginären Reise zu den unterschiedlichsten Orten, um 9 Inspirationsquellen in perfektem farbllichem Gleichgewicht aufzugreifen. Schlichte Formen und Vintage-Kombinationen erzählen durch zutiefst unterschiedlichen Oberflächen eine Geschichte, deren roter Faden die gleiche Philosophie von Eleganz aufweist.

Una selección refinada de piedras y mármoles, un viaje imaginario entre las sugerencias de lugares distintos donde recoger 9 fuentes de inspiración con un equilibrio cromático perfecto. Formas esenciales y combinaciones vintage cuentan una historia a través de superficies profundamente diferentes, con una misma filosofía de elegancia como leitmotiv.

STONES&MORE 2.0

STONE MARFIL



STONE CALACATTA



V3

R9
(smooth)

DCOF>
0,42 Wet
(smooth)

9 mm 3/8" ↑↓



V3

R10
CLASSE B
(comfort)

DCOF>
0,42 Wet
(smooth/
comfort)

BS EN 16165
ANNEX C
>36 Wet
slider 4S
(comfort)

6 mm 1/4" ↑↓

FLOORM OVERSIZE
magnUlm

GRES FINE PORCELLANATO

FINE PORCELAIN STONEWARE/GRES CERAME FIN/FEINSTEINZEUG-KOLLEKTIONEN/GRES PORCELANICO FINO
SQUADRATO - SQUARED - EQUARRI - REKTIFIZIERT - ESCUADRADO

				9 mm 3/8" ↑↓													
		COLOR	SURFACE	80x180 31 1/2" x 70 6/7"	60x120 23 5/8" x 47 1/4"	80x80 31 1/2" x 31 1/2"	40x80 15 3/4" x 31 1/2"	60x60 23 5/8" x 23 5/8"	30x60 11 1/4" x 23 5/8"								
STONES&MORE 2.0	STONE MARFIL	GLOSSY	741848 ■ FL-11900	742087 ■ FL-11300	742074 ■ FL-10800	756220 ■ FL-09100	756239 ■ FL-09100	756252 ■ FL-07700									
			741846 ■ FL-10500	742081 ■ FL-09900	742068 ■ FL-09300	743134 ■ FL-07300	742836 ■ FL-07300	756245 ■ FL-06200									
	STONE CALACATTA	GLOSSY	741847 ■ FL-11900	742086 ■ FL-11300	742073 ■ FL-10800	756221 ■ FL-09100	756240 ■ FL-09100	756253 ■ FL-07700									
			741845 ■ FL-10500	742080 ■ FL-09900	742067 ■ FL-09300	743133 ■ FL-07300	742835 ■ FL-07300	756246 ■ FL-06200									
	STONES&MORE 2.0	STONE MARFIL	GLOSSY	757758 ■ FL-15100	756499 ■ FL-14000	756498 ■ FL-12400	756502 ■ FL-11300										
				SMOOTH	757759 ■ FL-12400	745934 ■ FL-11300	745935 ■ FL-09700	756496 ■ FL-09100									
COMFORT					776853 ■ FL-12400	776329 ■ FL-11300	776336 ■ FL-09700	776341 ■ FL-09100									
STONE CALACATTA		GLOSSY	757760 ■ FL-15100	751779 ■ FL-14000	751781 ■ FL-12400	751782 ■ FL-11300											
			SMOOTH	757761 ■ FL-12400	744310 ■ FL-11300	744309 ■ FL-09700	744306 ■ FL-09100										
				COMFORT	776334 ■ FL-12400	776330 ■ FL-11300	776337 ■ FL-09700	776342 ■ FL-09100									

STONE ZECEVO



STONE SAHARA NOIR

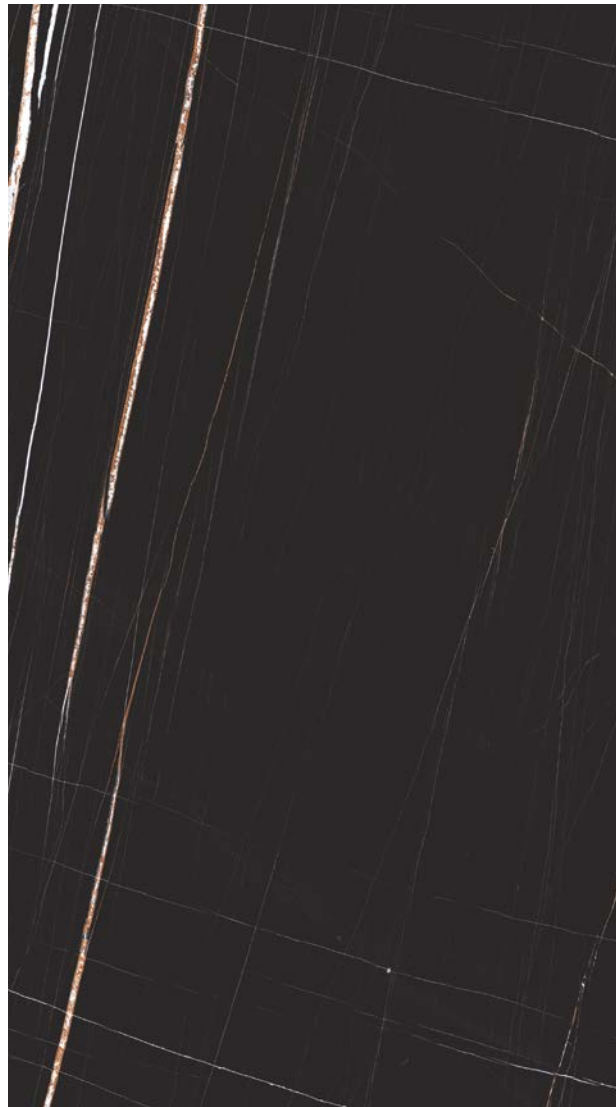

R9
(matte)
DCOF>
0,42 Wet
(matte)

9 mm 3/8" ↑↓





R10
CLASSE B
(comfort)
DCOF>
0,42 Wet
(matte/
comfort)

BS EN 16165
ANNEX C
>36 Wet
slider 4S
(comfort)

6 mm 1/4" ↑↓
FLORIM OVERSIZE
magnum

GRES FINE PORCELLANATO
FINE PORCELAIN STONEWARE/GRES CERAME FIN/FEINSTEINZEUG-KOLLEKTIONEN/GRES PORCELANICO FINO
SQUADRATO - SQUARED - EQUARRI - REKTIFIZIERT - ESCUADRADO

9 mm 3/8" ↑↓		COLOR	SURFACE	80x180 31 1/2" x 70 6/7"	60x120 23 5/8" x 47 1/4"	80x80 31 1/2" x 31 1/2"	40x80 15 3/4" x 31 1/2"	60x60 23 5/8" x 23 5/8"	30x60 11 4/5" x 23 5/8"
STONES&MORE 2.0		STONE ZECEVO	MATTE	741849 ■ FL-10500	742079 ■ FL-09900	742066 ■ FL-09300	756219 ■ FL-07300	756238 ■ FL-07300	756251 ■ FL-06200
		STONE SAHARA NOIR	GLOSSY	752797 ■ FL-11900	752799 ■ FL-11300	752800 ■ FL-10800	756222 ■ FL-09100	756241 ■ FL-09100	756254 ■ FL-07700
MATTE			756197 ■ FL-10500	756226 ■ FL-09900	756208 ■ FL-09300	756215 ■ FL-07300	756234 ■ FL-07300	756247 ■ FL-06200	

6 mm 1/4" ↑↓		COLOR	SURFACE	120x240 47 1/4" x 94 1/2"	120x120 47 1/4" x 47 1/4"	60x120 23 5/8" x 47 1/4"
STONES&MORE 2.0		STONE SAHARA NOIR	GLOSSY	752806 ■ FL-14000	752805 ■ FL-12400	752804 ■ FL-11300
			COMFORT	776331 ■ FL-11300	776338 ■ FL-09700	776343 ■ FL-09100

STONES&MORE 2.0

STONE BURL WHITE



ARABESCATO WHITE



V4
STONE
BURL WHITE

R10
(matte)
DCOF >
0,42 Wet
(matte)

9 mm 3/8" ↑↓

V3
ARABESCATO
WHITE

R9
(matte)
DCOF >
0,42 Wet
(matte)

6 mm 1/4" ↑↓

GRES FINE PORCELLANATO
FINE PORCELAIN STONWARE/GRES CERAME FIN/FEINSTEINZEUG-KOLLEKTIONEN/GRES PORCELANICO FINO
SQUADRATO - SQUARED - EQUARRI - REKTIFIZIERT - ESCUADRADO

9 mm 3/8" ↑↓		COLOR	SURFACE	80x180 31 1/2" x 70 6/7"	60x120 23 5/8" x 47 1/4"	80x80 31 1/2" x 31 1/2"	40x80 15 3/4" x 31 1/2"	60x60 23 5/8" x 23 5/8"	30x60 11 4/5" x 23 5/8"
STONES&MORE 2.0		STONE BURL WHITE	GLOSSY	756207 ■ FL-11900	742088 ■ FL-11300	742075 ■ FL-10800	742110 ■ FL-09100	742100 ■ FL-09100	756259 ■ FL-07700
			MATTE	756202 ■ FL-10500	742082 ■ FL-09900	742069 ■ FL-09300	742106 ■ FL-07300	742096 ■ FL-07300	742104 ■ FL-06200

6 mm 1/4" ↑↓		COLOR	SURFACE	120x240 47 1/4" x 94 1/2"	120x120 47 1/4" x 47 1/4"	60x120 23 5/8" x 47 1/4"
STONES&MORE 2.0		ARABESCATO WHITE	GLOSSY	756538 ■ FL-14000	756537 ■ FL-12400	756541 ■ FL-11300

AMANI BRONZE



STONE CALACATTA BLACK



R9
(matte
smooth)

DCOF>
0,42 Wet
(matte/smooth)

9 mm 3/8" ↑↓



R10
CLASSE B
(comfort)

DCOF>
0,42 Wet
(comfort)

BS EN 16165
ANNEX C
>36 Wet
slider 4S
(comfort)

6 mm 1/4" ↑↓









GRES FINE PORCELLANATO
FINE PORCELAIN STONWARE/GRES CERAME FIN/FEINSTEINZEUG-KOLLEKTIONEN/GRES PORCELANICO FINO
SQUADRATO - SQUARED - EQUARRI - REKTIFIZIERT - ESCUADRADO

		COLOR	SURFACE	80x180 31 1/2"x70 6/7"	60x120 23 5/8"x47 1/4"	80x80 31 1/2"x31 1/2"	40x80 15 3/4"x31 1/2"	60x60 23 5/8"x23 5/8"	30x60 11 4/5"x23 5/8"
STONES&MORE 2.0		AMANI BRONZE	GLOSSY	756205 ■ FL-11900	756233 ■ FL-11300	756214 ■ FL-10800	756225 ■ FL-09100	756244 ■ FL-09100	756257 ■ FL-07700
			MATTE	756200 ■ FL-10500	756230 ■ FL-09900	756211 ■ FL-09300	756218 ■ FL-07300	756237 ■ FL-07300	756250 ■ FL-06200
		STONE CALACATTA BLACK	GLOSSY	756204 ■ FL-11900	756232 ■ FL-11300	756213 ■ FL-10800	756224 ■ FL-09100	756243 ■ FL-09100	756256 ■ FL-07700
			SMOOTH	756199 ■ FL-10500	756229 ■ FL-09900	756210 ■ FL-09300	756217 ■ FL-07300	756236 ■ FL-07300	756249 ■ FL-06200

		COLOR	SURFACE	120x280 47 1/4"x110 1/4"	120x240 47 1/4"x94 1/2"	120x120 47 1/4"x47 1/4"	60x120 23 5/8"x47 1/4"
STONES&MORE 2.0		AMANI BRONZE	GLOSSY	-	756521 ■ FL-14000	756520 ■ FL-12400	756525 ■ FL-11300
			COMFORT	-	776332 ■ FL-11300	776339 ■ FL-09700	776344 ■ FL-09100
		STONE CALACATTA BLACK	GLOSSY	757762 ■ FL-15100	756554 ■ FL-14000	756553 ■ FL-12400	756557 ■ FL-11300
			COMFORT	776335 ■ FL-12400	776333 ■ FL-11300	776340 ■ FL-09700	776345 ■ FL-09100

STONES&MORE 2.0







9 mm 3/8" ↓				30x30 11 ^{4/5"} x11 ^{4/5"} mosaico tessere 5x5	30x30 11 ^{4/5"} x11 ^{4/5"} mosaico tessere 3x3	30x60 11 ^{4/5"} x23 ^{5/8"} modulo listello sfalsato	15x60 6 ^{1/4"} x23 ^{5/8"} modulo listello sfalsato 3D pz/box 6
STONES&MORE 2.0		STONE MARFIL	GLOSSY	-	756687 ■ FL-23600	742286 ■ FL-21000	756709 ▲ FL-03600
			SMOOTH	756681 ■ FL-15600	-	742279 ■ FL-18800	742292 ▲ FL-03600
		STONE CALACATTA	GLOSSY	-	756688 ■ FL-23600	742285 ■ FL-21000	756710 ▲ FL-03600
			SMOOTH	756682 ■ FL-15600	-	742278 ■ FL-18800	742291 ▲ FL-03600
		STONE ZECEVO	MATTE	742265 ■ FL-15600	-	742280 ■ FL-18800	742293 ▲ FL-03600
			GLOSSY	-	752802 ■ FL-23600	752803 ■ FL-21000	756716 ▲ FL-03600
		STONE SAHARA NOIR	MATTE	756685 ■ FL-15600	-	756697 ■ FL-18800	756707 ▲ FL-03600
			GLOSSY	-	742269 ■ FL-23600	742287 ■ FL-21000	756714 ▲ FL-03600
		STONE BURL WHITE	MATTE	742266 ■ FL-15600	-	742281 ■ FL-18800	742294 ▲ FL-03600
			GLOSSY	-	756689 ■ FL-23600	756700 ■ FL-21000	756711 ▲ FL-03600
		AMANI BRONZE	MATTE	756683 ■ FL-15600	-	756694 ■ FL-18800	756705 ▲ FL-03600
			GLOSSY	-	756686 ■ FL-23600	756698 ■ FL-21000	756708 ▲ FL-03600
	STONE CALACATTA BLACK	SMOOTH	756680 ■ FL-15600	-	756692 ■ FL-18800	756704 ▲ FL-03600	



In relazione alle differenti tecnologie produttive l'accostamento di prodotti con spessori diversi potrebbe presentare delle disomogeneità, se ne sconsiglia pertanto l'abbinamento. / Due to the different production technologies, contiguous installation of products with different thickness may give a non-homogeneous result. For this reason we do not recommend this option. / Vu que différentes technologies de production sont utilisées avec des épaisseurs différentes, des problèmes d'homogénéité pourraient se présenter, il est donc déconseillé de les poser ensemble. / Wegen unterschiedlicher Produktionstechnologien können die Fliesen mit verschiedenen Materialstärken optische Differenzen aufweisen. Von einem direkten Aneinanderlegen wird deshalb abgeraten. / Dadas las diferentes tecnologías productivas, la combinación de productos de diferentes espesores podría dar lugar a heterogeneidad, por lo que se desaconseja mezclarlas.

Per un effetto ottimale della posa, florim suggerisce di mantenere 2 mm di fuga per pose monoformato e 3 mm per combinare formati misti. - For optimal installation results, florim recommends maintaining a joint of 2 mm 1/12" for single format installations and 3 mm 1/8" to combine mixed formats. - Pour réaliser une pose parfaite, florim suggère de maintenir 2 mm de joint pour la pose des monoformats, et 3 mm pour les combinaisons de formats mixtes. - Um einen optimalen effekt beim verlegen zu erzielen empfiehlt florim eine 2 mm fugе bei einformatigen verlegungen und 3 mm fugе bei formatkombinationen Para lograr los máximos resultados en la posa del producto, florim aconseja 2 mm de junta en aplicaciones monoformato y 3 mm en combinaciones de formatos mixtos.

PEZZI SPECIALI/SPECIAL TRIMS/PIÈCES SPÉCIALES/FORMSTÜCKE/PIEZAS ESPECIALES

9 mm 3/8" ↓		COLOR	SURFACE	4,6x60 1 4/5" x 23 5/8" battiscopa	15x40 6" x 15 3/4" cove base pz/box 8	33x120x3 13" x 47 1/4" x 1 1/8" gradino pz/box 2	33x120 13" x 47 1/4" angolo gradino DX pz/box 2	33x120 13" x 47 1/4" angolo gradino SX pz/box 2
STONES&MORE 2.0		STONE MARFIL	GLOSSY	756722 ◆ FL-01600	-	-	-	-
			SMOOTH	745394 ◆ FL-01600	742332 ▲ FL-02400	742316 ▲ FL-20400	742308 ▲ FL-31100	742324 ▲ FL-31100
		STONE CALACATTA	GLOSSY	756723 ◆ FL-01600	-	-	-	-
			SMOOTH	745392 ◆ FL-01600	742331 ▲ FL-02400	742315 ▲ FL-20400	742307 ▲ FL-31100	742323 ▲ FL-31100
		STONE ZECEVO	MATTE	745391 ◆ FL-01600	742333 ▲ FL-02400	742317 ▲ FL-20400	742309 ▲ FL-31100	742325 ▲ FL-31100
		STONE SAHARA NOIR	GLOSSY	752814 ◆ FL-01600	-	-	-	-
			MATTE	756720 ◆ FL-01600	756733 ▲ FL-02400	756740 ▲ FL-20400	756760 ▲ FL-31100	756749 ▲ FL-31100
		STONE BURL WHITE	GLOSSY	756727 ◆ FL-01600	-	-	-	-
			MATTE	745389 ◆ FL-01600	742334 ▲ FL-02400	742318 ▲ FL-20400	742310 ▲ FL-31100	742326 ▲ FL-31100
		AMANI BRONZE	GLOSSY	756724 ◆ FL-01600	-	-	-	-
			MATTE	756718 ◆ FL-01600	756730 ▲ FL-02400	756737 ▲ FL-20400	756757 ▲ FL-31100	756744 ▲ FL-31100
		STONE CALACATTA BLACK	GLOSSY	756721 ◆ FL-01600	-	-	-	-
			SMOOTH	756717 ◆ FL-01600	756729 ▲ FL-02400	756736 ▲ FL-20400	756753 ▲ FL-31100	756741 ▲ FL-31100

FLORIM OVERSIZE
magnUm

120x280/120x240/120x120/80x80/60x120









Specifica Imballo pag.
Packaging specifications on page
Spécifications d'emballage à page
Verpackungsdetail Seite
Especificaciones de embalaje a la página
154/155









STONES&MORE 2.0	scatola - box			pallet		
	pz	mq	kg	box	mq	kg
80x180	2	2,88	57,60	20	57,60	1210
60x120	2	1,44	28,08	30	43,20	870
80x80	2	1,28	24,96	40	51,20	1030
40x80	3	0,96	18,53	56	53,76	1070
60x60	3	1,08	21,06	40	43,20	870
30x60	6	1,08	20,84	40	43,20	860
30x30 mosaico	10	0,90	19,17	30	27,00	610

STONES&MORE 2.0	scatola - box			pallet		
	pz	ml	kg	box	mq	kg
4,6x60 battiscopa	14	8,40	8,40	-	-	-

STONES&MORE 2.0

PEZZI SPECIALI/SPECIAL TRIMS/PIÈCES SPÉCIALES/FORMSTÜCKE/PIEZAS ESPECIALES

9 mm 3/8" ↑↓				1,2x30 1/2"x11 ^{4/5} "  quarter round pz/box 12	1,2x31,2 1/2"x11 ^{4/5} "  angolo quarter round pz/box 4
		COLOR			
STONES&MORE 2.0		STONE MARFIL	GLOSSY	756770 ▲ FL-01500	756793 ▲ FL-01700
			SMOOTH	742340 ▲ FL-01500	742348 ▲ FL-01700
		STONE CALACATTA	GLOSSY	756772 ▲ FL-01500	756794 ▲ FL-01700
			SMOOTH	742339 ▲ FL-01500	742347 ▲ FL-01700
		STONE ZECEVO	MATTE	742341 ▲ FL-01500	742349 ▲ FL-01700
		STONE SAHARA NOIR	GLOSSY	756778 ▲ FL-01500	756800 ▲ FL-01700
			MATTE	756765 ▲ FL-01500	756789 ▲ FL-01700
		STONE BURL WHITE	GLOSSY	756776 ▲ FL-01500	756798 ▲ FL-01700
			MATTE	742342 ▲ FL-01500	742350 ▲ FL-01700
		AMANI BRONZE	GLOSSY	756773 ▲ FL-01500	756795 ▲ FL-01700
			MATTE	756763 ▲ FL-01500	756783 ▲ FL-01700
		STONE CALACATTA BLACK	GLOSSY	756767 ▲ FL-01500	756791 ▲ FL-01700
SMOOTH			756761 ▲ FL-01500	756782 ▲ FL-01700	

6 mm 1/4" ↑↓				30x30 1 1/4"x11 4/5"  mosaico tessere 7,5x7,5 pz/box 11	30x30 1 1/4"x11 4/5"  muretto tessere 7,5x15 pz/box 11
		COLOR			
STONES&MORE 2.0		STONE MARFIL	GLOSSY	756814 ▲ FL-02100	756822 ▲ FL-02100
			SMOOTH	747827 ▲ FL-01800	747842 ▲ FL-01800
		STONE CALACATTA	GLOSSY	752811 ▲ FL-02100	752812 ▲ FL-02100
			SMOOTH	747828 ▲ FL-01800	747843 ▲ FL-01800
		STONE SAHARA NOIR	GLOSSY	752808 ▲ FL-02100	752809 ▲ FL-02100
		ARABESCATO WHITE	GLOSSY	756816 ▲ FL-02100	756824 ▲ FL-02100
		AMANI BRONZE	GLOSSY	756815 ▲ FL-02100	756823 ▲ FL-02100
		STONE CALACATTA BLACK	GLOSSY	756813 ▲ FL-02100	756821 ▲ FL-02100







PEZZI SPECIALI/SPECIAL TRIMS
PIÈCES SPÉCIALES/FORMSTÜCKE
PIEZAS ESPECIALES

4,6x80 1 4/5"x3 1/2"  battiscopa
756806 ◆ FL-01800
747903 ◆ FL-01800
752813 ◆ FL-01800
747904 ◆ FL-01800
752810 ◆ FL-01800
756808 ◆ FL-01800
756807 ◆ FL-01800
756805 ◆ FL-01800

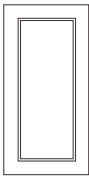
PASTA BIANCA

WHITE BODY/PÂTE BLANCHE/WEISSSCHERBIGE/PASTA BLANCA
SQUADRATO - SQUARED - EQUARRI - REKTIFIZIERT - ESCUADRADO

11,5 mm 1/2" ↑↓

	COLOR	SURFACE	48,15x96,3 19"x38"	5,5x48,15 2 1/8"x19"	2,2x5,5 6/7"x2 1/8"	15x48,15 6"x19"	2,5x15 1"x6"	1,5x32 3/5"x12 1/2"
			 boiserie A	 listello pz/box 12	 angolo listello pz/box 4	 alzata pz/box 4	 angolo alzata pz/box 4	 profilo pz/box 6
STONES&MORE 2.0	 WHITE	GLOSSY	742641 ■ FL-39700	742652 ▲ FL-03600	743120 ▲ FL-03100	742654 ▲ FL-04900	743118 ▲ FL-04900	743122 ▲ FL-02400



STONES&MORE 2.0	scatola - box			pallet		
	pz	mq	kg	box	mq	kg
48,15x96,3	3	1,40	30,40	12	16,80	390

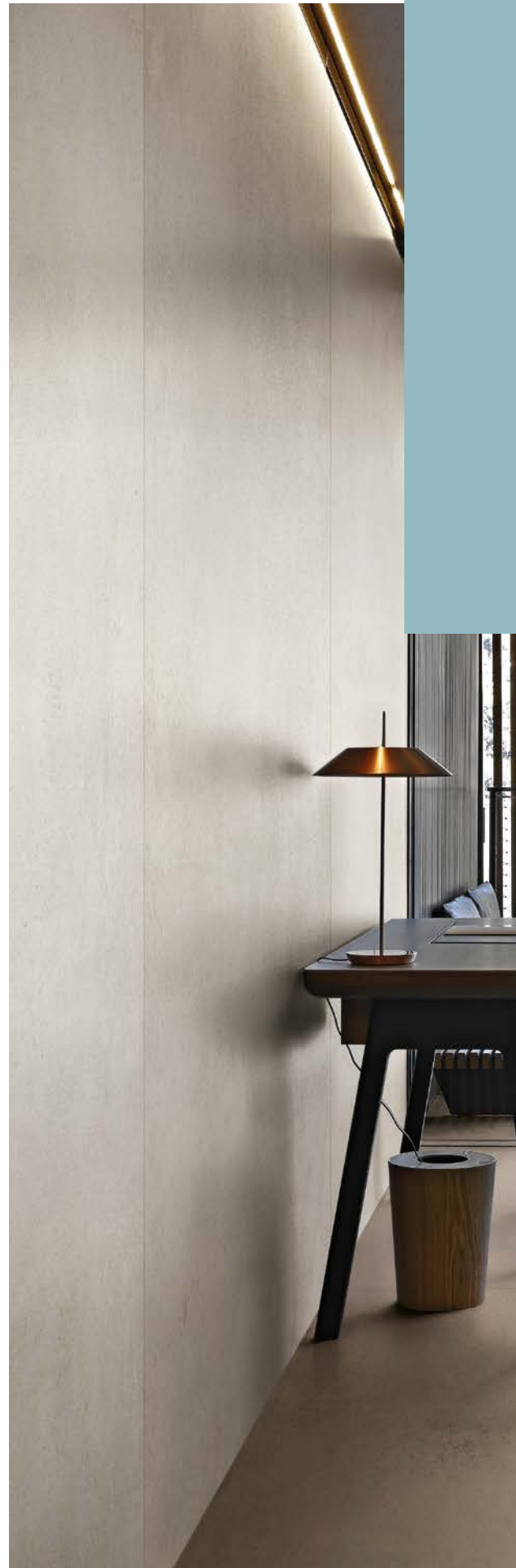

"STUDIOS"

gres fine porcellanato
fine porcelain stoneware
grès cérame fin
feinsteinzeug-kollektionen
gres porcelánico fino





“STUDIOS”

“**Studios**” con la sua personalità sofisticata ma discreta, definisce il percorso evolutivo delle moderne superfici di ispirazione cementizia per l'architettura d'interni.

“**Studios**”, with its sophisticated but discrete personality, defines the evolutionary path of modern cement-inspired surfaces for interior architecture.

“**Studios**”, avec sa personnalité à la fois sophistiquée et discrète, définit le parcours évolutif des surfaces modernes inspirées du béton et destinées à l'architecture d'intérieur.

“**Studios**” zeichnet sich durch seine anspruchsvolle, aber unaufdringliche Persönlichkeit aus, die entscheidend für die Entwicklung moderner Oberflächen mit zementartiger Inspiration im Bereich der Inneneinrichtung ist.

“**Studios**”, con su personalidad sofisticada pero discreta, define la trayectoria evolutiva de las superficies modernas inspiradas en el cemento para la arquitectura de interiores.

"STUDIOS"

CHALK



SAND

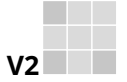

R10
CLASSE B
(matte)

DCOF>
0,42 Wet
(matte)

9 mm 3/8" ↑↓

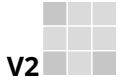

R10
CLASSE B
(R+PTV)

DCOF>
0,42 Wet
(matte/
R+PTV)

BS EN 16165
ANNEX C
>36 Wet
slider 4S
(R+PTV)

6 mm 1/4" ↑↓

FLORM OVERSIZE
magnUm

GRES FINE PORCELLANATO
FINE PORCELAIN STONWARE/GRES CERAME FIN/FEINSTEINZEUG-KOLLEKTIONEN/GRES PORCELANICO FINO
SQUADRATO - SQUARED - EQUARRI - REKTIFIZIERT - ESCUADRADO

9 mm 3/8" ↑↓		COLOR	SURFACE	60x120 23 ^{5/8} "x47 ^{1/4} "	80x80 31 ^{1/2} "x31 ^{1/2} "	60x60 23 ^{5/8} "x23 ^{5/8} "	
"STUDIOS"		CHALK	MATTE	758031 ■ FL-09300	758025 ■ FL-08600	758037 ■ FL-06200	
		SAND	MATTE	758032 ■ FL-09300	758026 ■ FL-08600	758038 ■ FL-06200	
6 mm 1/4" ↑↓		COLOR	SURFACE	120x280 47 ^{1/4} "x110 ^{1/4} "	120x240 47 ^{1/4} "x94 ^{1/2} "	120x120 47 ^{1/4} "x47 ^{1/4} "	60x120 23 ^{5/8} "x47 ^{1/4} "
"STUDIOS"		CHALK	MATTE	758140 ■ FL-12400	758146 ■ FL-11300	758158 ■ FL-09700	758170 ■ FL-09100
			R+PTV	-	758816 ■ FL-11300	758164 ■ FL-09700	-
		SAND	MATTE	758141 ■ FL-12400	758147 ■ FL-11300	758159 ■ FL-09700	758171 ■ FL-09100

BRICK

CLOUD

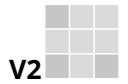

V2
R10
CLASSE B
 (matte)

DCOF>
 0,42 Wet
 (matte)

9 mm 3/8" ↑↓

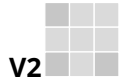

V2
R10
CLASSE B
 (R+PTV)



DCOF>
 0,42 Wet
 (matte/
 R+PTV)

BS EN 16165
 ANNEX C
 >36 Wet
 slider 4S
 (R+PTV)

6 mm 1/4" ↑↓

FLOHM OVERSIZE
magnUm

GRES FINE PORCELLANATO
 FINE PORCELAIN STONEWARE/GRES CERAME FIN/FEINSTEINZEUG-KOLLEKTIONEN/GRES PORCELANICO FINO
 SQUADRATO - SQUARED - EQUARRI - REKTIFIZIERT - ESCUADRADO

9 mm 3/8" ↑↓		COLOR	SURFACE	60x120 23 ^{5/8"} x47 ^{1/4"}	80x80 31 ^{1/2"} x31 ^{1/2"}	60x60 23 ^{5/8"} x23 ^{5/8"}	
"STUDIOS"		BRICK	MATTE	758028 ■ FL-09300	758022 ■ FL-08600	758034 ■ FL-06200	
		CLOUD	MATTE	758030 ■ FL-09300	758024 ■ FL-08600	758036 ■ FL-06200	
6 mm 1/4" ↑↓		COLOR	SURFACE	120x280 47 ^{1/4"} x110 ^{1/4"}	120x240 47 ^{1/4"} x94 ^{1/2"}	120x120 47 ^{1/4"} x47 ^{1/4"}	60x120 23 ^{5/8"} x47 ^{1/4"}
"STUDIOS"		CLOUD	MATTE	758139 ■ FL-12400	758145 ■ FL-11300	758157 ■ FL-09700	758169 ■ FL-09100
			R+PTV	-	758819 ■ FL-11300	758163 ■ FL-09700	-

"STUDIOS"

CONCRETE



RUBBER

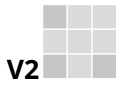

R10
CLASSE B
(matte)

DCOF>
0,42 Wet
(matte)

9 mm 3/8" ↑↓

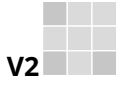

R10
CLASSE B
(R+PTV)

DCOF>
0,42 Wet
(matte/
R+PTV)

BS EN 16165
ANNEX C
>36 Wet
slider 4S
(R+PTV)







6 mm 1/4" ↑↓

FLOHM OVERSIZE
magnUm





GRES FINE PORCELLANATO
FINE PORCELAIN STONEWARE/GRES CERAME FIN/FEINSTEINZEUG-KOLLEKTIONEN/GRES PORCELANICO FINO
SQUADRATO - SQUARED - EQUARRI - REKTIFIZIERT - ESCUADRADO

9 mm 3/8" ↑↓		COLOR	SURFACE	60x120 23 ^{5/8} "x47 ^{1/4} "	80x80 31 ^{1/2} "x31 ^{1/2} "	60x60 23 ^{5/8} "x23 ^{5/8} "	
"STUDIOS"		CONCRETE	MATTE	758029 ■ FL-09300	758023 ■ FL-08600	758035 ■ FL-06200	
		RUBBER	MATTE	758027 ■ FL-09300	758021 ■ FL-08600	758033 ■ FL-06200	
6 mm 1/4" ↑↓		COLOR	SURFACE	120x280 47 ^{1/4} "x110 ^{1/4} "	120x240 47 ^{1/4} "x94 ^{1/2} "	120x120 47 ^{1/4} "x47 ^{1/4} "	60x120 23 ^{5/8} "x47 ^{1/4} "
"STUDIOS"		CONCRETE	MATTE	758138 ■ FL-12400	758144 ■ FL-11300	758156 ■ FL-09700	758168 ■ FL-09100
			R+PTV	-	758820 ■ FL-11300	758162 ■ FL-09700	-
		RUBBER	MATTE	758136 ■ FL-12400	758142 ■ FL-11300	758154 ■ FL-09700	758166 ■ FL-09100







9 mm 3/8" ↑↓

	COLOR	SURFACE	30x30 11 ^{4/5} "x11 ^{4/5} " 	
"STUDIOS"		CHALK	MATTE	758229 ▲ FL-01500
		SAND	MATTE	758230 ▲ FL-01500
		BRICK	MATTE	758226 ▲ FL-01500
		CLOUD	MATTE	758228 ▲ FL-01500
		CONCRETE	MATTE	758227 ▲ FL-01500
		RUBBER	MATTE	758225 ▲ FL-01500

PEZZI SPECIALI/SPECIAL TRIMS
PIÈCES SPÉCIALES/FORMSTÜCKE/PIEZAS ESPECIALES

4,6x80 1 ^{4/5} "x31 ^{1/2} " 	33x120x3 13"x47 ^{1/4} "x1 ^{1/8} " 	33x120 13"x47 ^{1/4} " 	33x120 13"x47 ^{1/4} " 
battiscopa	gradino pz/box 2	angolo gradino DX pz/box 2	angolo gradino SX pz/box 2
758235 ◆ FL-01600	758241 ▲ FL-20400	758247 ▲ FL-31100	758253 ▲ FL-31100
758236 ◆ FL-01600	758242 ▲ FL-20400	758248 ▲ FL-31100	758254 ▲ FL-31100
758232 ◆ FL-01600	758238 ▲ FL-20400	758244 ▲ FL-31100	758250 ▲ FL-31100
758234 ◆ FL-01600	758240 ▲ FL-20400	758246 ▲ FL-31100	758252 ▲ FL-31100
758233 ◆ FL-01600	758239 ▲ FL-20400	758245 ▲ FL-31100	758251 ▲ FL-31100
758231 ◆ FL-01600	758237 ▲ FL-20400	758243 ▲ FL-31100	758249 ▲ FL-31100

6 mm 1/4" ↑↓

	COLOR	SURFACE	30x30 11 ^{4/5} "x11 ^{4/5} " 	30x30 11 ^{4/5} "x11 ^{4/5} " 	
"STUDIOS"		CHALK	MATTE	758259 ▲ FL-01800	758265 ▲ FL-01800
		SAND	MATTE	758260 ▲ FL-01800	758266 ▲ FL-01800
		CLOUD	MATTE	758258 ▲ FL-01800	758264 ▲ FL-01800
		CONCRETE	MATTE	758257 ▲ FL-01800	758263 ▲ FL-01800
		RUBBER	MATTE	758255 ▲ FL-01800	758261 ▲ FL-01800

PEZZI SPECIALI/SPECIAL TRIMS
PIÈCES SPÉCIALES/FORMSTÜCKE
PIEZAS ESPECIALES

4,6x60 1 ^{4/5} "x23 ^{5/8} " 
battiscopa
758271 ◆ FL-01800
758272 ◆ FL-01800
758270 ◆ FL-01800
758269 ◆ FL-01800
758267 ◆ FL-01800

9 mm 3/8" ↑↓



FLORIM OVERSIZE
magnlum

120x280/120x240/120x120/60x120

Specifica Imballo pag.
Packaging specifications on page
Spécifications d'emballage à page
Verpackungsdetail Seite
Especificaciones de embalaje a la página
154/155

In relazione alle differenti tecnologie produttive l'accostamento di prodotti con spessori diversi potrebbe presentare delle disomogeneità, se ne sconsiglia pertanto l'abbinamento. Due to the different production technologies, contiguous installation of products with different thickness may give a non-homogeneous result. For this reason we do not recommend this option. / Vu que différentes technologies de production sont utilisées avec des épaisseurs différentes, des problèmes d'homogénéité pourraient se présenter, il est donc déconseillé de les poser ensemble. / Wegen unterschiedlicher Produktionstechnologien können die Fliesen mit verschiedenen Materialstärken optische Differenzen aufweisen. Von einem direkten Aneinanderlegen wird deshalb abgeraten. / Dadas las diferentes tecnologías productivas, la combinación de productos de diferentes espesores podría dar lugar a heterogeneidad, por lo que se desaconseja mezclarlas.

Per un effetto ottimale della posa, florim suggerisce di mantenere 2 mm di fuga per pose monoformato e 3 mm per combinare formati misti. - For optimal installation results, florim recommends maintaining a joint of 2 mm 1/12" for single format installations and 3 mm 1/8" to combine mixed formats. - Pour réaliser une pose parfaite, florim suggère de maintenir 2 mm de joint pour la pose des monoformats, et 3 mm pour les combinaisons de formats mixtes. - Um einen optimalen effekt beim verlegen zu erzielen empfiehlt florim eine 2 mm fuge bei einformatigen verlegungen und 3 mm fuge bei formatkombinationen. Para lograr los máximos resultados en la posa del producto, florim aconseja 2 mm de junta en aplicaciones monoformato y 3 mm en combinaciones de formatos mixtos.

"STUDIOS"	scatola - box			pallet		
	pz	mq	kg	box	mq	kg
60x120	2	1,44	28,08	30	43,20	870
80x80	2	1,28	24,96	40	51,20	1030
60x60	3	1,08	21,06	40	43,20	870

"STUDIOS"	scatola - box			pallet		
	pz	ml	kg	box	mq	kg
4,6x80 battiscopa	12	9,60	9,60	-	-	-

"STUDIOS" OUTDOOR

Vantaggi tecnici - Technical advantages - Avantages techniques Technische Vorteile - Ventajas técnicas

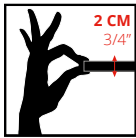

- Lastra monolitica compatta di spessore 2 cm squadrata e rettificata
- Compact monolithic slab 2 cm thick squared and rectified
- Dalle monolithique compacte de 2 cm d'épaisseur, égarrie et rectifiée
- Kompakte monolithische Platte, 2 cm dick, rechteckig und scharfkantig geschliffen
- Losa monolítica compacta de 2 cm de espesor, esquadrada y rectificada.

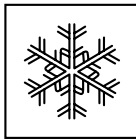

- INGELIVO
- FROST RESISTANT
- INGÉLIF
- FROSTBESTÄNDIG
- RESISTENTE A LA HELADA

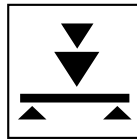

- ELEVATA RESISTENZA AI CARICHI STATICI
- HIGH STATIC LOAD RESISTANCE
- RÉSISTANCE ÉLEVÉE AUX CHARGES STATIQUES
- HOHE STATISCHE BELASTBARKEIT
- ELEVADA RESISTENCIA A LAS CARGAS ESTÁTICAS

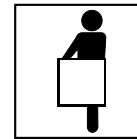

- FACILE DA POSARE
- EASY TO INSTALL
- FACILE À POSER
- VERLEGELEICHT
- FÁCIL DE COLOCAR



- ANTISCIVOLO R11
- ANTI SLIP R11
- ANTIDÉRAPANT R11
- RUTSCHFEST R11
- ANTIDESLIZANTE R11

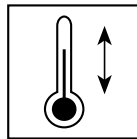

- RESISTENTE AGLI SBALZI TERMICI
- THERMAL SHOCK RESISTANT
- RÉSISTANT AUX ÉCARTS THERMIQUES
- TEMPERATURWECHSELBESTÄNDIG
- RESISTENTE A LAS OSCILACIONES TÉRMICAS



- FACILE DA PULIRE
- EASY TO CLEAN
- FACILE À NETTOYER
- REINIGUNGSLEICHT
- FÁCIL DE LIMPIAR

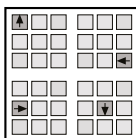

- RIMOVIBILE E RIUTILIZZABILE
- REMOVABLE AND REUSABLE
- DÉMONTABLE ET RÉUTILISABLE
- ENTFERNBAR UND WIEDERVERWENDBAR
- DESMONTABLE Y REUTILIZABLE



- INATTACCABILE DA AGENTI CHIMICI E MUFFE
- IMPERVIUS TO ATTACK BY CHEMICALS OR MOULD
- RÉSISTANT AUX AGENTS CHIMIQUES ET AUX MOISSISSURES
- UNANGREIFBAR DURCH CHEMISCHE STOFFE UND SCHIMMEL
- RESISTENTE A LOS AGENTES QUÍMICOS Y A LOS MOHOS

Applicazioni - Applications - Applications - Verlegung - Aplicaciones

- Posa diretta su erba
- Direct installation on grass
- Pose direct sur de l'herbe
- Verlegung direkt auf Rasen
- Colocación directa sobre hierba



- Posa diretta su ghiaia
- Direct installation over gravel
- Pose direct sur du gravier
- Verlegung direkt auf Kies
- Colocación directa sobre grava



- Posa su massetto cementizio
- Installation on sand-cement screed
- Pose sur chape ciment
- Verlegung auf Zement-Unterbetonblock
- Colocación sobre contrapiso de hormigón

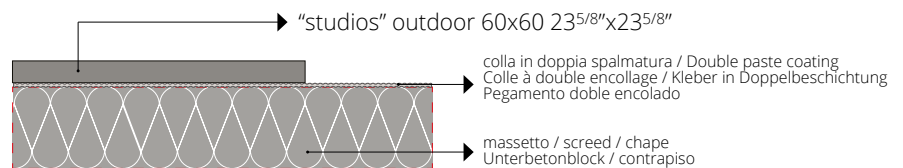

- Posa su piedini fissi o regolabili
- Installation on fixed or adjustable feet
- Pose sur pieds fixes ou réglables
- Verlegung auf feststehende oder regulierbare Füße
- Colocación sobre pies fijos o regulables

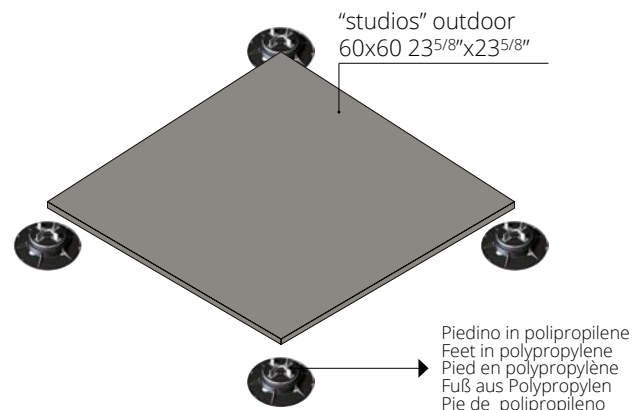

Per le specifiche di utilizzo dei sistemi sopraelevati vedi il sito florim.com
For the specifics on use of raised systems visit the site florim.com
Pour les caractéristiques d'utilisation des systèmes surélevés, voir le site florim.com
Für die Nutzungsbedingungen der Doppelbodensysteme siehe Webseite florim.com
Para las especificaciones de empleo de los sistemas sobreelevados consulte el sitio web florim.com

Le lastre ceramiche sono sottoposte a un trattamento di compattazione termica che assicura resistenza e durata nel tempo. Il bassissimo assorbimento d'acqua rende perciò il materiale ingelivo. Ciò può comportare ristagni d'acqua superficiali anche per materiale installato a regola d'arte. / Ceramic tiles undergo a compacting thermal treatment that ensures resistance and durability. The low level of water absorption makes the slabs frost resistant. This could result in superficial water stagnations even if materials are installed in a workmanlike manner. / Les carreaux de céramique subissent un traitement thermique de compactage qui assure résistance et durabilité. Le bas niveau d'absorption d'eau rend les dalles résistant au gel. Il pourrait en résulter des stagnations d'eau superficielles, même si les dalles ont été installées dans les règles de l'art. / Die Keramikplatten werden einer thermischen Verdichtung unterzogen, welche die Widerstandsfähigkeit und Langlebigkeit sichert. Die extrem niedrige Wasseraufnahme macht das Material frostsicher. Die hohe Materialdichte kann, auch bei einer perfekten Verlegung, eine längere Abtrochnungszeit von angestauretem Wasser zur Folge haben. / Las baldosas cerámicas se someten a un tratamiento de compactación térmica que asegura resistencia y durabilidad. La baja absorción de agua hace que las baldosas resistan al hielo. Esto podría resultar en estancamientos superficiales de agua, incluso si los materiales están instalados según las reglas del arte.

CLOUD

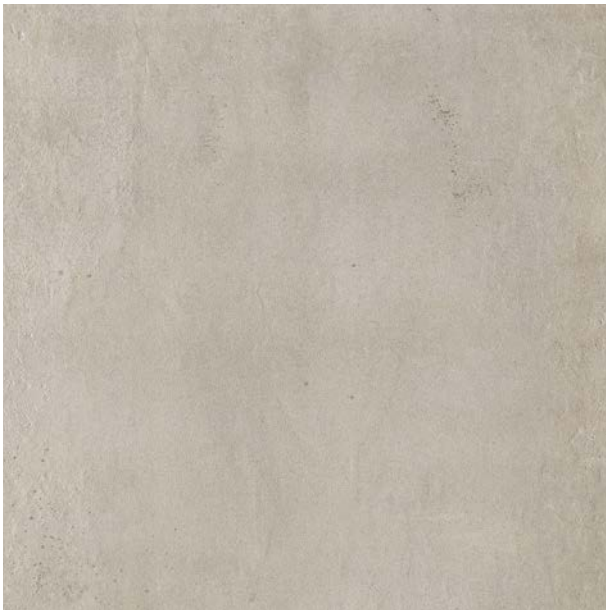

CONCRETE



R11
CLASSE C



20 mm 3/4"

RUBBER



GRES FINE PORCELLANATO

FINE PORCELAIN STONEWARE/GRES CERAME FIN/FEINSTEINZEUG-KOLLEKTIONEN/GRES PORCELANICO FINO
SQUADRATO - SQUARED - EQUARRI - REKTIFIZIERT - ESCUADRADO

		COLOR	SURFACE	60x60 23 ⁵ / ₈ "x23 ⁵ / ₈ "
"STUDIOS"		CLOUD	GRIP	758047 ■ FL-07700
		CONCRETE	GRIP	758046 ■ FL-07700
		RUBBER	GRIP	758045 ■ FL-07700

PEZZI SPECIALI

Special trims/Pièces spéciales/Formstücke
Piezas especiales

pag 144/147



Recycled material content certification

CLOUD - CONCRETE

ISO 10545-4	RESISTENZA ALLA FLESSIONE IN N/mm ² N/mm ² FLEXURAL STRENGTH TEST / RESISTANCE A LA FLEXION EN N/mm ² / BIEGEFESTIGKEIT IN N/mm ² / RESISTENCIA A LA FLEXION EN N/mm ²	valore medio 52 N/mm ²
	Forza di rottura in N (sp. > 7,5 mm) Breaking strength in N (thickness > 7,5 mm) / Force de rupture en N (ép. > 7,5 mm) / Bruchlast in N (Dicke > 7,5 mm) / Fuerza de rotura en N (gr. > 7,5 mm)	valore medio 14000 N

"STUDIOS"	scatola - box			pallet		
	pz	mq	kg	box	mq	kg
60x60 20mm	2	0,72	32,15	30	21,60	990



URBAN STYLE

gres fine porcellanato
fine porcelain stoneware
grès cérame fin
feinsteinzeug-kollektionen
gres porcelánico fino





URBAN STYLE

La cura di ogni dettaglio, lo sviluppo del disegno e delle sfumature di colore attraverso i diversi formati rappresentano in pieno la cifra stilistica e il know-how del marchio Florim, capace di accendere con un feeling unico e inconfondibile qualsiasi materiale.

Attention to every detail, plus the development of the design and shades of colour through the different formats, represent in full the stylistic character and know-how of the Florim brand, to light up any material with a unique and unmistakable feeling.

Le soin apporté au moindre détail, le développement du dessin et des nuances de couleur à travers les différents formats représentent parfaitement le style et le savoir-faire de la marque Florim, capable de mettre n'importe quelle matière en valeur avec un feeling unique et incomparable.

Die Pflege jedes Details, die Entwicklung von Design und Farbnuancen mittels der verschiedenen Formate spiegeln in jeder Hinsicht den Stil und das Knowhow der Marke Florim wider, die jeder Art Material ein einzigartiges und unverwechselbares Feeling zu verleihen weiß.

El cuidado de los detalles, el desarrollo del diseño y los matices de color a través de distintos formatos representan por completo el código estilístico y el saber hacer de la marca Florim, capaz de aportar una sensación única e inconfundible a cualquier material.

URBAN STYLE

URBAN LIGHT



URBAN PLOMB

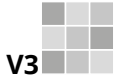



V3

R9

DCOF >
0,42 Wet





6 mm 1/4" ↑↓
FLOHM OVERSIZE
magnUm

GRES FINE PORCELLANATO
FINE PORCELAIN STONEWARE/GRES CERAME FIN/FEINSTEINZEUG-KOLLEKTIONEN/GRES PORCELANICO FINO
SQUADRATO - SQUARED - EQUARRI - REKTIFIZIERT - ESCUADRADO

6 mm 1/4" ↑↓	COLOR	SURFACE	120x240 47 ^{1/4"} x94 ^{1/2"}	120x120 47 ^{1/4"} x47 ^{1/4"}	60x120 23 ^{5/8"} x47 ^{1/4"}
	URBAN LIGHT	MATTE	757080 ■ FL-11300	757082 ■ FL-09700	757084 ■ FL-09100
	URBAN PLOMB	MATTE	757079 ■ FL-11300	757081 ■ FL-09700	757083 ■ FL-09100

URBAN STYLE

6 mm 1/4"

	COLOR	SURFACE	30x30 11 4/5" x 11 4/5"  mosaico tessere 7,5x7,5 pz/box 11	30x30 11 4/5" x 11 4/5"  muretto tessere 7,5x15 pz/box 11	4,6x60 1 4/5" x 23 3/8"  battiscopa
URBAN STYLE	 URBAN LIGHT	MATTE	757395 ▲ FL-01800	757397 ▲ FL-01800	757392 ◆ FL-01800
	 URBAN PLOMB	MATTE	757396 ▲ FL-01800	757398 ▲ FL-01800	757394 ◆ FL-01800

PEZZI SPECIALI/SPECIAL TRIMS
PIÈCES SPÉCIALES/FORMSTÜCKE
PIEZAS ESPECIALES

Per un effetto ottimale della posa, florim suggerisce di mantenere 2 mm di fuga per pose monoformato e 3 mm per combinare formati misti - For optimal installation results, florim recommends maintaining a joint of 2 mm 1/12" for single format installations and 3 mm 1/8" to combine mixed formats. - Pour réaliser une pose parfaite, florim suggère de maintenir 2 mm de joint pour la pose des monoformats, et 3 mm pour les combinaisons de formats mixtes. - Um einen optimalen effekt beim verlegen zu erzielen empfiehlt florim eine 2 mm fuge bei einformatigen verlegungen und 3 mm fuge bei formatkombinationen Para lograr los máximos resultados en la posa del producto, florim aconseja 2 mm de junta en aplicaciones monoformato y 3 mm en combinaciones de formatos mixtos.

FLORIM OVERSIZE
magnUm

120x240/120x120/60x120
Specifica Imballo pag.
Packaging specifications on page
Spécifications d'emballage à page
Verpackungsdetail Seite
Especificaciones de embalaje a la página
154/155



CREATIVE DESIGN / 128



VETRO





VETRO

La lavorazione artigianale del vetro e la ricerca del design contemporaneo rendono vetro Creative design unico ed esclusivo.

The craftsmanship of the glass and the quality of the contemporary design make vetro by Creative design unique and exclusive.

Le travail artisanal du verre et la recherche du design contemporain rendent le verre Creative design unique et exclusif.

Das von Hand bearbeitete Glas und der Einbezug zeitgenössischen Designs machen Vetro Creative design zu einzigartigen Produkten.

La elaboración artesanal del vidrio y la investigación del diseño contemporáneo logran que vetro Creative design sea único y exclusivo.

VETRO

VETRO
GLASS / VERRE / GLAS / VIDRIO

4,5 mm 1/8" ↑↓

COLOR

30x30
11 4/5" x 11 4/5"



mosaico neutra
tessere 1,8x1,8
pz/box 11

COLOR

30x30
11 4/5" x 11 4/5"



mosaico neutra lux
tessere 1,8x1,8
pz/box 11

V2

CLASSE C

4,5 mm 1/8" ↑↓

VETRO



01 BIANCO

735618
▲ FL-03300



01 BIANCO LUX

749610
▲ FL-03300



02 AVORIO

735619
▲ FL-03300



02 AVORIO LUX

735626
▲ FL-03300



03 SILVER

735620
▲ FL-03300



03 SILVER LUX

735627
▲ FL-03300



04 TORTORA

735621
▲ FL-03300



04 TORTORA LUX

735628
▲ FL-03300



05 CEMENTO

735622
▲ FL-03300



05 CEMENTO LUX

735629
▲ FL-03300



06 MOKA

735623
▲ FL-03300



06 MOKA LUX

735630
▲ FL-03300



07 CARBONE

735624
▲ FL-03300



07 CARBONE LUX

735631
▲ FL-03300

MOSAICO

montato su pellicola trasparente
mounted on transparent film
monté sur film transparent
auf transparenter Folie montiert
montado en una película transparente

Per la scheda tecnica di serie consultare il sito www.florim.com / For the standard technical sheet go to www.florim.com / Pour de plus amples informations sur la fiche technique de série, consultez le site www.florim.com / Das serien-datenblatt finden sie unter www.florim.com / Para la ficha técnica de serie consulte el sitio www.florim.com

VETRO
GLASS / VERRE / GLAS / VIDRIO

4,5 mm 1/8" ↓

COLOR

30x30
11 4/5" x 11 4/5"



mosaico melange
tessere 1,8x1,8
pz/box 11

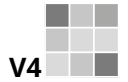

CLASSE C

4,5 mm 1/8" ↓



MELANGE CHIARO

735632
▲ FL-03300

VETRO



MELANGE MEDIO

735633
▲ FL-03300



MELANGE SCURO

735634
▲ FL-03300

MOSAICO
montato su pellicola trasparente
mounted on transparent film
monté sur film transparent
auf transparenter Folie montiert
montado en una película transparente

4,5 mm 1/8" ↓

COLOR

30x30
11 4/5" x 11 4/5"



mosaico metalli
tessere 1,8x1,8
pz/box 11



CLASSE C

4,5 mm 1/8" ↓



CROMO

735637
▲ FL-03600

VETRO



COBALTO

735638
▲ FL-03600

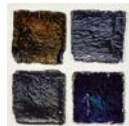

IRIDESCENTE

735639
▲ FL-03600

MOSAICO
montato su pellicola trasparente
mounted on transparent film
monté sur film transparent
auf transparenter Folie montiert
montado en una película transparente



WOODEN TILE

gres fine porcellanato
fine porcelain stoneware
grès cérame fin
feinsteinzeug-kollektionen
gres porcelánico fino





WOODEN TILE

Colori neutri dal disegno delicato d'ispirazione nordica, ma anche legno di recupero dai forti contrasti cromatici, Wooden Tile esprime la complessità del gusto contemporaneo fatto di accostamenti che sorprendono, dense atmosfere in cui il passare del tempo crea superfici ricche di significato.

Neutral colours with a delicate Nordic design combined with reclaimed wood in strong contrasting hues. Wooden Tile expresses the complexity of contemporary taste using surprising combinations and dense atmospheres in which the passage of time creates richly expressive surfaces.

Couleurs neutres au dessin délicat d'inspiration nordique, mais aussi bois de récupération aux forts contrastes chromatiques, Wooden Tile exprime la complexité du style contemporain fait d'approches qui surprennent, d'atmosphères denses où le temps qui passe crée des surfaces riches en significations.

Neutrale Farben von zartem, nordisch inspiriertem Design, aber auch Altholz von starken Farbkontrasten: Wooden Tile ist Ausdruck der Vielschichtigkeit des heutigen Geschmacks mit seinen auffallenden Kombinationen, dichte Atmosphären, in denen der Lauf der Zeit ausdrucksstarke Oberflächen erschafft.

Colores neutros con un dibujo delicado de inspiración nórdica, pero también madera recuperada con fuertes contrastes, Wooden Tile expresa la complejidad del gusto contemporáneo, conformado por combinaciones asombrosas, atmósferas densas donde el paso del tiempo crea superficies ricas de significados.

WOODEN TILE

WOODEN WHITE



WOODEN GRAY





R10
CLASSE A
(matte)

R11
CLASSE B
(strutturato)

9 mm 3/8" ↑↓

GRES FINE PORCELLANATO

FINE PORCELAIN STONEWARE/GRES CERAME FIN/FEINSTEINZEUG-KOLLEKTIONEN/GRES PORCELANICO FINO
SQUADRATO - SQUARED - EQUARRI - REKTIFIZIERT - ESCUADRADO

9 mm 3/8" ↑↓		COLOR	SURFACE	26,5x180 10 ^{9/16"} x70 ^{9/16"}	20x120 7 ^{7/8"} x47 ^{1/4"}	15x120 6"x47 ^{1/4"}
WOODEN TILE		WOODEN WHITE	MATTE	741863 ■ FL-12400	741873 ■ FL-09300	741878 ■ FL-09300
			STRUTTURATO	-	742719 ■ FL-09300	-
		WOODEN GRAY	MATTE	741864 ■ FL-12400	741874 ■ FL-09300	741879 ■ FL-09300
			STRUTTURATO	-	742720 ■ FL-09300	-

WOODEN ALMOND

WOODEN WALNUT





R10
CLASSE A
WOODEN
ALMOND
matte

R9
CLASSE A
WOODEN
WALNUT
matte

R11
CLASSE B
(strutturato)

9 mm 3/8" ↑↓

GRES FINE PORCELLANATO
FINE PORCELAIN STONEWARE/GRES CERAME FIN/FEINSTEINZEUG-KOLLEKTIONEN/GRES PORCELANICO FINO
SQUADRATO - SQUARED - EQUARRI - REKTIFIZIERT - ESCUADRADO

9 mm 3/8" ↑↓		COLOR	SURFACE	26,5x180 10 ^{3/4"} x70 ^{3/4"}	20x120 7 ^{7/8"} x47 ^{1/4"}	15x120 6"x47 ^{1/4"}
WOODEN TILE		WOODEN ALMOND	MATTE	741865 ■ FL-12400	741875 ■ FL-09300	741880 ■ FL-09300
			STRUTTURATO	-	742721 ■ FL-09300	-
		WOODEN WALNUT	MATTE	741866 ■ FL-12400	741876 ■ FL-09300	741881 ■ FL-09300
			STRUTTURATO	-	742722 ■ FL-09300	-

WOODEN TILE

WOODEN BROWN

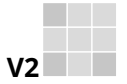

V2
R10
CLASSE A
 (matte)

R11
CLASSE B
 (strutturato)



9 mm 3/8" ↑

GRES FINE PORCELLANATO

FINE PORCELAIN STONEWARE/GRES CERAME FIN/FEINSTEINZEUG-KOLLEKTIONEN/GRES PORCELANICO FINO
 SQUADRATO - SQUARED - EQUARRI - REKTIFIZIERT - ESCUADRADO



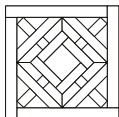

9 mm 3/8" ↑	COLOR	SURFACE	26,5x180	20x120	15x120
			10 ^{3/8"} x70 ^{3/8"}	7 ^{7/8"} x47 ^{1/4"}	6 ^{1/4"} x47 ^{1/4"}
WOODEN TILE	WOODEN BROWN	MATTE	741867 ■ FL-12400	741877 ■ FL-09300	741882 ■ FL-09300
		STRUTTURATO	-	742723 ■ FL-09300	-

9 mm 3/8" ↑↓

	COLOR	SURFACE	30x30 11 ^{4/5} "x11 ^{4/5} "  mosaico tessere 5x5	30x30 11 ^{4/5} "x11 ^{4/5} "  mosaico 3D sfalsato tessere 6x6 pz/box 6	20x60 7 ^{7/8} "x23 ^{5/8} "  modulo listello sfalsato	80x80 31 ^{1/2} "x31 ^{1/2} "  decor
	WOODEN WHITE	MATTE	741928 ■ FL-15600	742055 ▲ FL-03600	742060 ■ FL-21000	741893 ■ FL-10500
	WOODEN GRAY	MATTE	741929 ■ FL-15600	742056 ▲ FL-03600	742061 ■ FL-21000	741894 ■ FL-10500
WOODEN TILE	WOODEN ALMOND	MATTE	741930 ■ FL-15600	742057 ▲ FL-03600	742062 ■ FL-21000	741895 ■ FL-10500
	WOODEN WALNUT	MATTE	741931 ■ FL-15600	742058 ▲ FL-03600	742063 ■ FL-21000	741896 ■ FL-10500
	WOODEN BROWN	MATTE	741932 ■ FL-15600	742059 ▲ FL-03600	742064 ■ FL-21000	741897 ■ FL-10500

PEZZI SPECIALI/SPECIAL TRIMS/PIÈCES SPÉCIALES/FORMSTÜCKE/PIEZAS ESPECIALES

9 mm 3/8" ↑↓

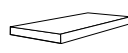
	COLOR	SURFACE	4,6x60 1 ^{4/5} "x23 ^{5/8} "  battiscopa	15x30x6 6" ¹ "x11 ^{4/5} "x2 ^{1/3} "  elemento elle strutturato pz/box 12	33x120x3 13" ³ "x47 ^{11/16} "x1 ^{1/16} "  gradino pz/box 2	33x120x3 13" ³ "x47 ^{11/16} "x1 ^{1/16} "  angolo gradino dx pz/box 2	33x120x3 13" ³ "x47 ^{11/16} "x1 ^{1/16} "  angolo gradino sx pz/box 2
	WOODEN WHITE	MATTE	745616 ◆ FL-01600	741903 ▲ FL-02400	741908 ▲ FL-20400	741913 ▲ FL-31100	741918 ▲ FL-31100
	WOODEN GRAY	MATTE	745614 ◆ FL-01600	741904 ▲ FL-02400	741909 ▲ FL-20400	741914 ▲ FL-31100	741919 ▲ FL-31100
WOODEN TILE	WOODEN ALMOND	MATTE	745612 ◆ FL-01600	741905 ▲ FL-02400	741910 ▲ FL-20400	741915 ▲ FL-31100	741920 ▲ FL-31100
	WOODEN WALNUT	MATTE	745615 ◆ FL-01600	741906 ▲ FL-02400	741911 ▲ FL-20400	741916 ▲ FL-31100	741921 ▲ FL-31100
	WOODEN BROWN	MATTE	745613 ◆ FL-01600	741907 ▲ FL-02400	741912 ▲ FL-20400	741917 ▲ FL-31100	741922 ▲ FL-31100

Nelle operazioni di posa a listoni sfalsati, si raccomanda sempre di fare in modo che il lato maggiore della piastrella termini a circa un terzo della lunghezza di quelle accanto (posa sfalsata "a 1/3"). - When installing staggered strips, we recommend that the tile's longer side should always end at about one-third of the length of the tiles next to it ("1/3" staggered installation). - Lors de la pose des listels décalés, il faut toujours faire en sorte que le côté le plus grand du carreau se trouve à environ 1/3 de la longueur des carreaux d'à côté (pose décalée "à 1/3"). - Beim Verlegen der Leisten in versetzter Form ist zu beachten, dass die höhere Seite der Fliese immer circa bei einem Drittel der Länge der sich daneben befindlichen Fliesen abschließt ("Um 1/3" versetzte Verlegung). - En las operaciones de colocación de listones escalonados, se recomienda hacerlo siempre de forma tal que el lado mayor del azulejo termine teniendo alrededor de un tercio de la longitud de los contiguos (colocación escalonada "a 1/3").

Per un effetto ottimale della posa, florim suggerisce di mantenere 2 mm di fuga per pose monoformato e 3 mm per combinare formati misti. - For optimal installation results, florim recommends maintaining a joint of 2 mm 1/12" for single format installations and 3 mm 1/8" to combine mixed formats. - Pour réaliser une pose parfaite, florim suggère de maintenir 2 mm de joint pour la pose des monoformats, et 3 mm pour les combinaisons de formats mixtes. - Um einen optimalen effekt beim verlegen zu erzielen empfiehlt florim eine 2 mm fugen bei einformatigen verlegungen und 3 mm fugen bei formatkombinationen. Para lograr los máximos resultados en la posa del producto, florim aconseja 2 mm de junta en aplicaciones monoformato y 3 mm en combinaciones de formatos mixtos.

WOODEN TILE	scatola - box			pallet		
	pz	mq	kg	box	mq	kg
26,5x180	3	1,44	28,80	42	60,48	1270
20x120	6	1,44	28,08	24	34,56	700
15x120	6	1,08	25,06	32	34,56	830
30x30 mosaico	10	0,90	19,17	30	27,00	610
20x60 mod listello sfalsato	6	0,72	15,34	50	36,00	800
80x80 decor	2	1,28	24,96	40	51,20	1030

WOODEN TILE	scatola - box			pallet		
	pz	ml	kg	box	mq	kg
4,6x60 battiscopa	14	8,40	8,40	-	-	-

OUTDOOR 20mm PEZZI SPECIALI

SPECIAL TRIMS
PIÈCES SPÉCIALES
FORMSTÜKE
PIEZAS ESPECIALES



CARATTERISTICHE TECNICHE



TECHNICAL FEATURES
CARACTÉRISTIQUES TECHNIQUES
TECHNISCHE EIGENSCHAFTEN
CARACTERÍSTICAS TÉCNICAS

Pezzi speciali Outdoor 20mm

Special trims/Pièces spèciales/Formstücke / Piezas especiales

Collections:

Onyx&more - Pietre/3 - Sensi Matteo Thun - Studios

Gradino toro

30x60 11^{4/5"}x23^{5/8"}_759177 ▲ FL-06400

40x120 15^{3/4"}x47^{1/4"}_759180 ▲ FL-20400

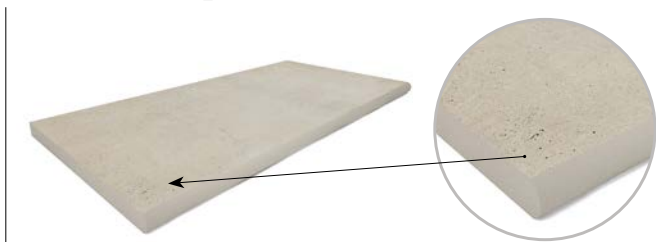

Collections:

Icon outdoor

Gradino toro

30x60 11^{4/5"}x23^{5/8"}_759177 ▲ FL-06400

40x120 15^{3/4"}x47^{1/4"}_759180 ▲ FL-20400

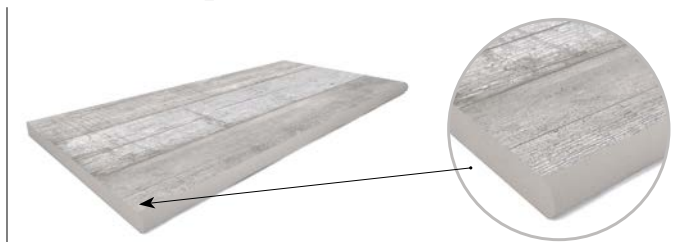

Gradino toro con gocciolatoio

30x60 11^{4/5"}x23^{5/8"}_759182 ▲ FL-09100

40x120 15^{3/4"}x47^{1/4"}_759185 ▲ FL-29000



Gradino toro con gocciolatoio

30x60 11^{4/5"}x23^{5/8"}_759182 ▲ FL-09100

40x120 15^{3/4"}x47^{1/4"}_759185 ▲ FL-29000

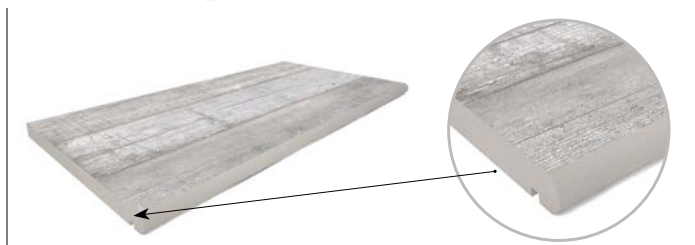

Gradino doppio toro

30x60 11^{4/5"}x23^{5/8"}_759187 ▲ FL-11300

40x120 15^{3/4"}x47^{1/4"}_759189 ▲ FL-36500

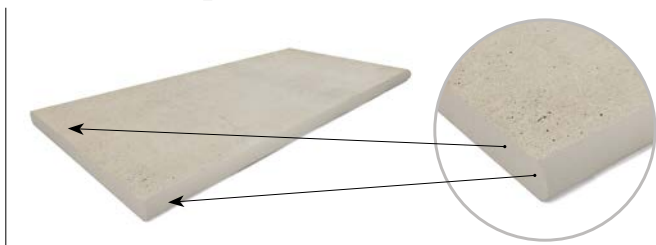

Gradino doppio toro

30x60 11^{4/5"}x23^{5/8"}_759187 ▲ FL-11300

40x120 15^{3/4"}x47^{1/4"}_759189 ▲ FL-36500

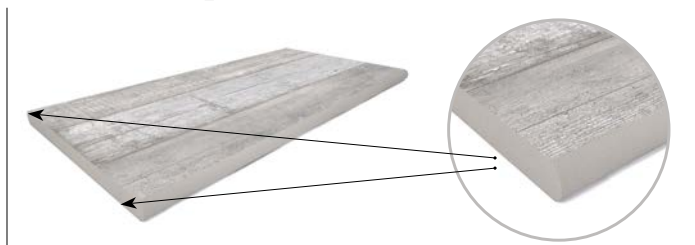

Gradino doppio toro con gocciolatoio

30x60 11^{4/5"}x23^{5/8"}_759191 ▲ FL-15600

40x120 15^{3/4"}x47^{1/4"}_759193 ▲ FL-29000

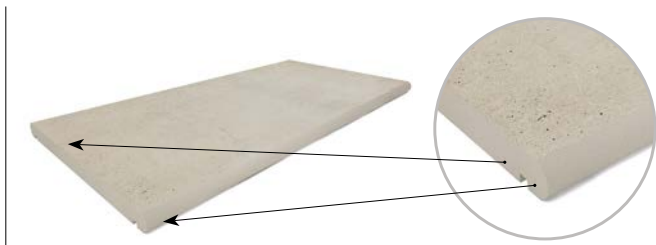

Gradino doppio toro con gocciolatoio

30x60 11^{4/5"}x23^{5/8"}_759191 ▲ FL-15600

40x120 15^{3/4"}x47^{1/4"}_759193 ▲ FL-29000

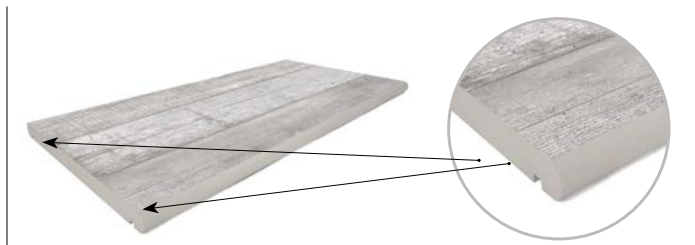

PEZZI SPECIALI OUTDOOR 20mm	scatola - box			pallet		
	pz	mq	kg	box	mq	kg
30x60 gradino toro	1	0,18	10,00	-	-	-
40x120 gradino toro	1	0,48	25,00	-	-	-
30x60 gradino toro con gocciolatoio	1	0,18	10,00	-	-	-
40x120 gradino toro con gocciolatoio	1	0,48	25,00	-	-	-
30x60 gradino doppio toro	1	0,18	10,00	-	-	-
40x120 gradino doppio toro	1	0,48	25,00	-	-	-
30x60 gradino doppio toro con gocciolatoio	1	0,18	10,00	-	-	-
40x120 gradino doppio toro con gocciolatoio	1	0,48	25,00	-	-	-

Collections:

Onyx&more - Pietre/3 - Sensi Matteo Thun - Studios

Elemento ad Elle Angolo SX

30x60x8 11^{4/5"}x23^{5/8"}x3^{1/8"}_759204 ▲ FL-14500

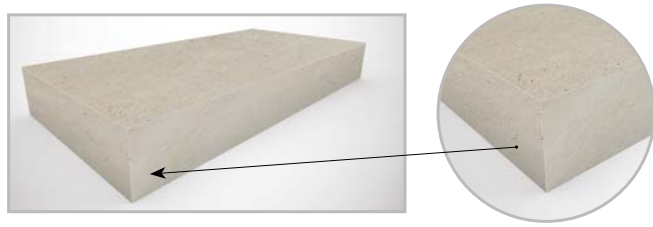

Elemento ad Elle

30x60x8 11^{4/5"}x23^{5/8"}x3^{1/8"}_759197 ▲ FL-09300

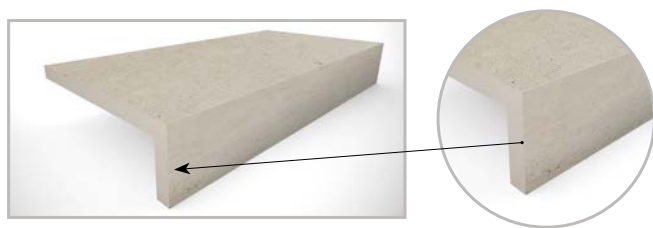

Elemento ad Elle Angolo DX

30x60x8 11^{4/5"}x23^{5/8"}x3^{1/8"}_759202 ▲ FL-14500

Elemento ad Elle Angolo SX

60x60x8 23^{5/8"}x23^{5/8"}x3^{1/8"}_759210 ▲ FL-19900

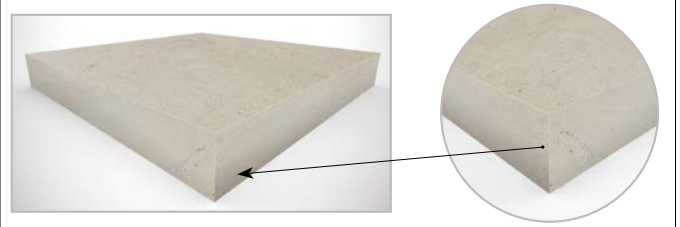

Elemento ad Elle

60x60x8 23^{5/8"}x23^{5/8"}x3^{1/8"}_759206 ▲ FL-14000

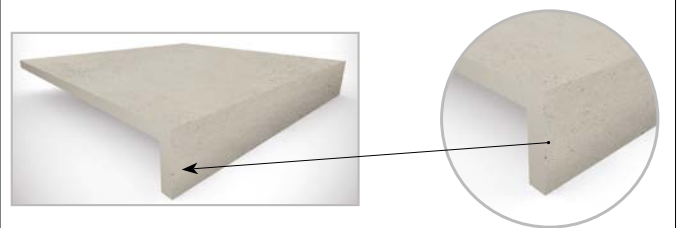

Elemento ad Elle Angolo DX

60x60x8 23^{5/8"}x23^{5/8"}x3^{1/8"}_759208 ▲ FL-19900

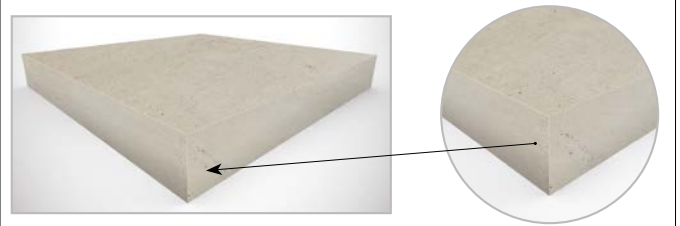
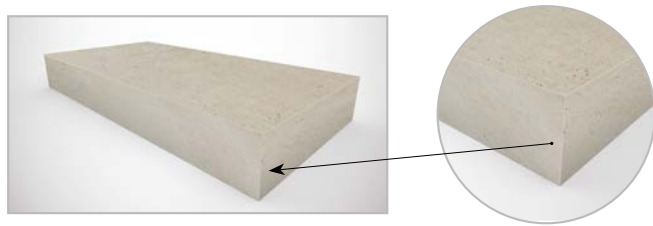

Pezzi speciali e fondo possono differire in termini di tonalità, il bordo può presentare stratificazioni di tonalità diverse.

Special pieces and field tiles may come in different shades, the slab's edge may show layers of differing hues.
 Il peut y avoir des différences de tonalités entre les pièces spéciales et le fond, le bord pourrait présenter des stratifications de tonalités différentes.
 Die Formteile können farblich von der Grundplatte abweichen, ihre Kanten können Schichtungen in unterschiedlichen Farbtönen aufweisen.
 Piezas especiales y bases pueden diferir en términos de tonalidad, el borde puede presentar estratificaciones de diferente tonalidad.

PEZZI SPECIALI OUTDOOR 20mm	scatola - box			pallet		
	pz	mq	kg	box	mq	kg
30x60x8 elemento ad elle angolo sx	1	0,18	10,00	-	-	-
30x60x8 elemento ad elle	1	0,18	10,00	-	-	-
30x60x8 elemento ad elle angolo dx	1	0,18	10,00	-	-	-
60x60x8 elemento ad elle angolo sx	1	0,36	20,00	-	-	-
60x60x8 elemento ad elle	1	0,36	20,00	-	-	-
60x60x8 elemento ad elle angolo dx	1	0,36	20,00	-	-	-

Pezzi speciali Outdoor 20mm

Special trims/Pièces spéciales/Formstücke / Piezas especiales

Collections: Icon outdoor

Elemento ad Elle Angolo A SX

30x60x8 11^{4/5"}x23^{5/8"}x3^{1/8"}_759220 ▲ FL-14500

40x120x8 15^{3/4"}x47^{1/4"}x3^{1/8"}_759183 ▲ FL-29000

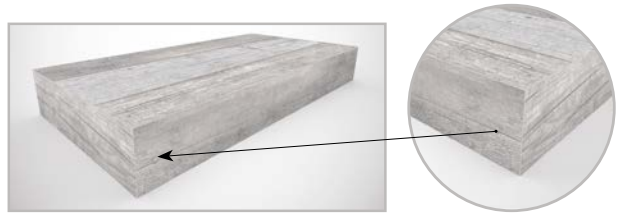

Elemento ad Elle A

30x60x8 11^{4/5"}x23^{5/8"}x3^{1/8"}_759217 ▲ FL-09300

40x120x8 15^{3/4"}x47^{1/4"}x3^{1/8"}_759165 ▲ FL-19900

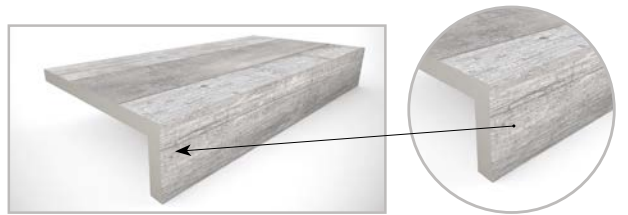

Elemento ad Elle Angolo A DX

30x60x8 11^{4/5"}x23^{5/8"}x3^{1/8"}_759160 ▲ FL-14500

40x120x8 15^{3/4"}x47^{1/4"}x3^{1/8"}_759178 ▲ FL-29000

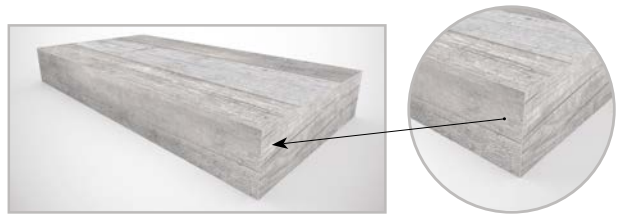

Elemento ad Elle Angolo A SX

60x60x8 11^{4/5"}x23^{5/8"}x3^{1/8"}_759164 ▲ FL-19900

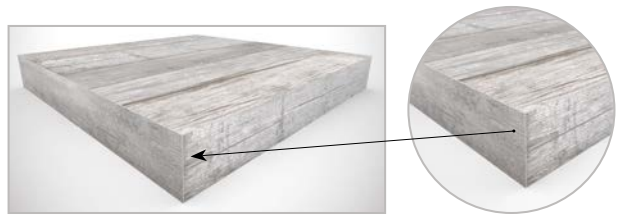

Elemento ad Elle A

60x60x8 11^{4/5"}x23^{5/8"}x3^{1/8"}_759161 ▲ FL-14000

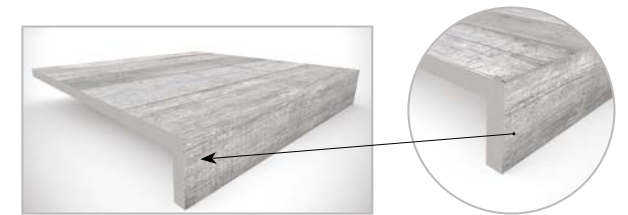

Elemento ad Elle Angolo A DX

60x60x8 11^{4/5"}x23^{5/8"}x3^{1/8"}_759163 ▲ FL-19900

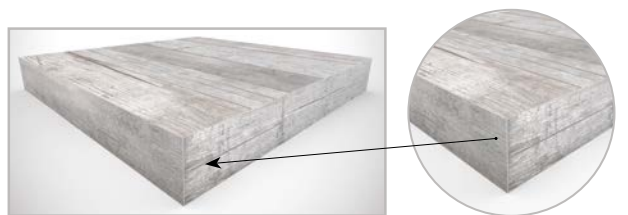

Elemento ad Elle Angolo B SX

30x60x8 11^{4/5"}x23^{5/8"}x3^{1/8"}_759194 ▲ FL-14500

40x120x8 15^{3/4"}x47^{1/4"}x3^{1/8"}_759200 ▲ FL-29000

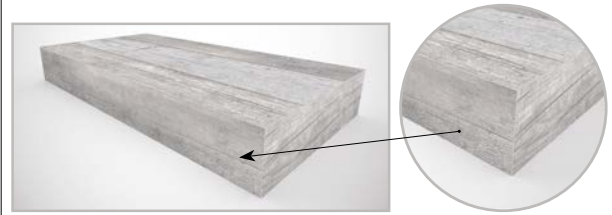

Elemento ad Elle B

30x60x8 11^{4/5"}x23^{5/8"}x3^{1/8"}_759218 ▲ FL-09300

40x120x8 15^{3/4"}x47^{1/4"}x3^{1/8"}_759213 ▲ FL-19900

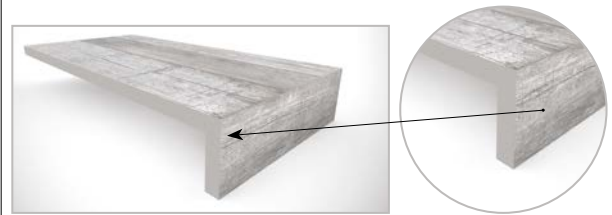

Elemento ad Elle Angolo B DX

30x60x8 11^{4/5"}x23^{5/8"}x3^{1/8"}_759219 ▲ FL-14500

40x120x8 15^{3/4"}x47^{1/4"}x3^{1/8"}_759199 ▲ FL-29000

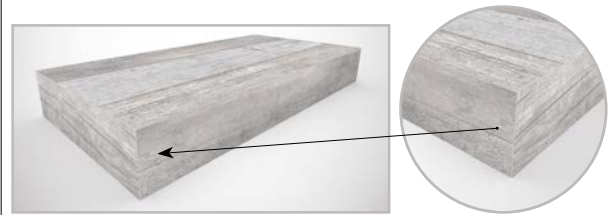

Elemento ad Elle Angolo B SX

60x60x8 11^{4/5"}x23^{5/8"}x3^{1/8"}_759198 ▲ FL-19900

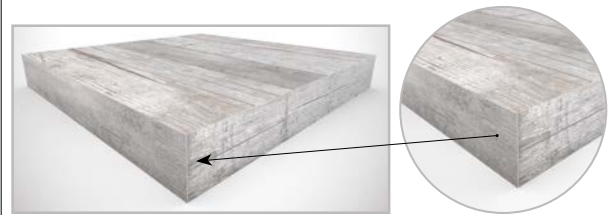

Elemento ad Elle B

60x60x8 11^{4/5"}x23^{5/8"}x3^{1/8"}_759162 ▲ FL-14000

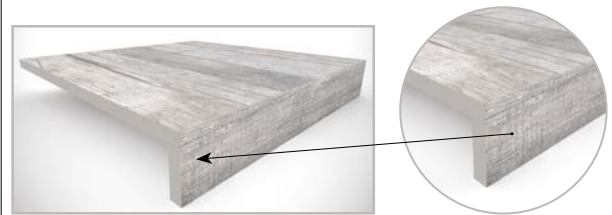

Elemento ad Elle Angolo B DX

60x60x8 11^{4/5"}x23^{5/8"}x3^{1/8"}_759195 ▲ FL-19900

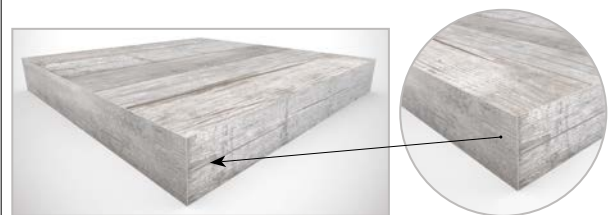

Collections: Icon outdoor



esempio di posa elemento elle A + angolo A SX
40x120x8 $15\frac{3}{4}'' \times 47\frac{1}{4}'' \times 3\frac{1}{8}''$ - **30x60x8** $11\frac{4}{5}'' \times 23\frac{5}{8}'' \times 3\frac{1}{8}''$



esempio di posa elemento elle B + angolo B SX
40x120x8 $15\frac{3}{4}'' \times 47\frac{1}{4}'' \times 3\frac{1}{8}''$ - **30x60x8** $11\frac{4}{5}'' \times 23\frac{5}{8}'' \times 3\frac{1}{8}''$



esempio di posa elemento elle A + angolo A SX
60x60x8 $23\frac{5}{8}'' \times 23\frac{5}{8}'' \times 3\frac{1}{8}''$



esempio di posa elemento elle B + angolo B SX
60x60x8 $23\frac{5}{8}'' \times 23\frac{5}{8}'' \times 3\frac{1}{8}''$

Pezzi speciali e fondo possono differire in termini di tonalità, il bordo può presentare stratificazioni di tonalità diverse.

Special pieces and field tiles may come in different shades, the slab's edge may show layers of differing hues.
 Il peut y avoir des différences de tonalités entre les pièces spéciales et le fond, le bord pourrait présenter des stratifications de tonalités différentes.
 Die Formteile können farblich von der Grundplatte abweichen, ihre Kanten können Schichtungen in unterschiedlichen Farbtönen aufweisen.
 Piezas especiales y bases pueden diferir en términos de tonalidad, el borde puede presentar estratificaciones de diferente tonalidad.

PEZZI SPECIALI OUTDOOR 20mm	scatola - box		
	pz	mq	kg
elemento ad elle angolo A sx 30x60x8	1	0,18	10,10
elemento ad elle angolo A sx 40x120x8	1	0,48	25,10
elemento ad elle A 30x60x8	1	0,18	10,10
elemento ad elle A 40x120x8	1	0,48	25,10
elemento ad elle angolo A dx 30x60x8	1	0,18	10,10
elemento ad elle angolo A dx 40x120x8	1	0,48	25,10
elemento ad elle angolo A sx 60x60x8	1	0,36	20,10
elemento ad elle A 60x60x8	1	0,36	20,10
elemento ad elle angolo A dx 60x60x8	1	0,36	20,10
elemento ad elle angolo B sx 30x60x8	1	0,18	10,10
elemento ad elle angolo B sx 40x120x8	1	0,48	25,10
elemento ad elle B 30x60x8	1	0,18	10,10
elemento ad elle B 40x120x8	1	0,48	25,10
elemento ad elle angolo B dx 30x60x8	1	0,18	10,10
elemento ad elle angolo B dx 40x120x8	1	0,48	25,10
elemento ad elle angolo B sx 60x60x8	1	0,36	20,10
elemento ad elle B 60x60x8	1	0,36	20,10
elemento ad elle angolo B dx 60x60x8	1	0,36	20,10

BORDO VASCA

SWIMMING POOL EDGE
BORD DE PISCINE
BECKENRAND
BORDE DE LA TINA



CARATTERISTICHE TECNICHE



TECHNICAL FEATURES
CARACTÉRISTIQUES TECHNIQUES
TECHNISCHE EIGENSCHAFTEN
CARACTERISTICAS TÉCNICAS

WAVE/SPECIALPIECES

BORDO VASCA / SWIMMING POOL EDGE / BORD DE PISCINE
BECKENRAND / BORDE DE LA TINA

WAVE LINEARE



40,5x80 16"x31^{1/2}"

762864

▲ FL-21000

30,5x60 12"x23^{5/8}"

771428

▲ FL-13400

WAVE ANGOLO AE



40,5x40,5 16"x16"

762874

▲ FL-27900

30,5x30,5 12"x12"

771429

▲ FL-19400

WAVE ANGOLO AI 45°



40,5x80x80 16"x31^{1/2}"x31^{1/2}"

762869

▲ FL-44100

30,5x60x60 12"x23^{5/8}"x23^{5/8}"

771432

▲ FL-29000

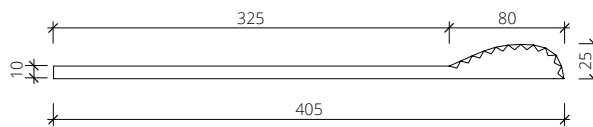
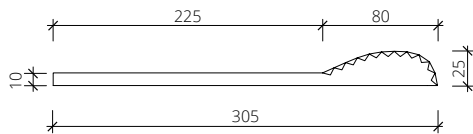

BORDO PER PISCINA "WAVE"

Rivoluzionario pezzo speciale che, attraverso l'accostamento di una serie di listelli opportunamente conformati su un lato del pezzo, rende ottimale la tracimazione, il contenimento dell'acqua, nonché l'appiglio manuale. La flessibilità progettuale di questo pezzo consente di realizzare bordi con diversi materiali Florim selezionati tra le serie che presentano le più elevate proprietà antiscivolo a piedi nudi (classe A+B+C, rif. norma DIN 51097).

"WAVE" SWIMMING POOL EDGE

Revolutionary border tile that, by placing together a set of suitably shaped strips on one side of the tile, makes an efficient overflow, containing the water and also offering a hand-grip. The flexibility of the design of this tile enables edges to be created with different Florim materials selected from the ranges that have the highest barefoot slip-resistance ratings (Class A+B+C, according to DIN 51097 standard).

BORD POUR PISCINE « WAVE »

Pièce spéciale révolutionnaire qui, grâce à la juxtaposition d'une série de listels dûment disposés sur un côté de la pièce, optimise le débordement, le confinement de l'eau, ainsi que le point d'accroche avec les mains. La flexibilité de conception de cette pièce permet de réaliser des bords avec différents matériaux Florim sélectionnés parmi les séries dotées des plus hautes propriétés antidérapantes pieds nus (classe A+B+C, réf. norme DIN 51097).

BECKENRANDSTEIN "WAVE"

Ein revolutionäres Spezialteil, das durch das Aneinandersetzen einer Reihe von Leisten, die an einer Seite des Spezialteils zweckmäßig geformt sind, eine ausgezeichnete Überflutung, Wassereindämmung und Griffkante bietet. Die flexible Projektanpassung dieses Spezialteils erlaubt die Gestaltung von Beckenrändern mit verschiedenen Florim-Materialien, ausgewählt unter den Produktserien mit der höchsten Barfuß-Rutschfestigkeit (Klasse A+B+C, Bezugsnorm DIN 51097).

BORDE PARA PISCINA «WAVE»

Pieza especial revolucionaria que se remata por un lado con una serie de listones de forma especial, para ofrecer un desbordamiento y retención del agua óptimos, así como un excelente asidero manual. La flexibilidad de diseño de esta pieza permite realizar bordes con varios materiales de Florim, seleccionados entre las series que presentan las más altas propiedades antideslizantes con pies descalzos (clase A+B+C, ref. norma DIN 51097).

OCEAN/SPECIALPIECES

BORDO VASCA / SWIMMING POOL EDGE / BORD DE PISCINE
BECKENRAND / BORDE DE LA TINA

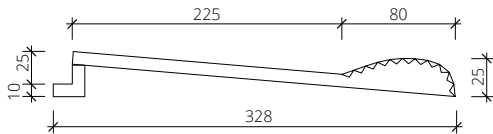

BORDO PER PISCINA "OCEAN"

Innovativo e rivoluzionario pezzo speciale progettato appositamente per essere utilizzato come bordo piscina con sistema ad acqua traboccante a sfioro. E' composto da un pezzo che, attraverso l'accostamento di una serie di listelli opportunamente conformati su un lato del pezzo, rende ottimale la tracimazione, il contenimento dell'acqua, nonché l'appiglio manuale. La flessibilità progettuale di questo pezzo consente di realizzare bordi con diversi materiali Florim selezionati tra le serie che presentano le più elevate proprietà antiscivolo a piedi nudi (classe A+B+C, rif. norma DIN 51097). Questo pezzo speciale comprende anche l'angolare in porcellanato per appoggio e contenimento griglia.

"OCEAN" SWIMMING POOL EDGE

Innovative, revolutionary border tile specially designed to be used as a swimming pool edge with overflow system. It comprises a piece that, by placing together a set of suitably shaped strips on one side of the tile, makes an efficient overflow, containing the water and also offering a hand-grip. The flexibility of the design of this tile enables edges with different Florim materials to be created, selecting them from the ranges that have the highest barefoot slip-resistance ratings (Class A+B+C, according to DIN 51097 standard). This special piece also includes the porcelain stoneware corner element for setting and containing the grating.

BORD POUR PISCINE « OCEAN »

Pièce spéciale innovante et révolutionnaire spécialement conçue pour être utilisée comme bord de piscine à débordement avec système de trop-plein. Grâce à la juxtaposition d'une série de listels dûment disposés sur un de ses côtés, cette pièce, optimise le débordement, le confinement de l'eau, ainsi que le point d'accroche avec les mains. La flexibilité de conception de cette pièce permet de réaliser des bords avec différents matériaux Florim sélectionnés parmi les séries dotées des plus hautes propriétés antidérapantes pieds nus (classe A+B+C, réf. norme DIN 51097). Cette pièce spéciale comprend également une pièce d'angle en grès cérame pour le support et le confinement de la grille.

BECKENRANDSTEIN "OCEAN"

Dieses innovative und revolutionäre Spezialteil wurde speziell für die Verwendung als Rand für Schwimmbecken mit Wasserüberlaufrinne entwickelt. Es besteht aus einem Teil, das durch das Aneinandersetzen einer Reihe von Leisten, die an einer Seite des Teils zweckmäßig geformt sind, eine ausgezeichnete Überflutung, Wassereindämmung und Griffkante bietet. Die flexible Projektanpassung dieses Spezialteils erlaubt die Gestaltung von Beckenrändern mit verschiedenen Florim-Materialien, ausgewählt unter den Produktserien mit der höchsten Barfuß-Rutschfestigkeit (Klasse A+B+C, Bezugsnorm DIN 51097). Dieses Spezialteil enthält auch das Eckstück aus Feinsteinzeug zur Aufnahme des Rostes.

BORDE PARA PISCINA «OCEAN»

Pieza especial, innovadora y revolucionaria, diseñada específicamente para usarse como borde de piscina con sistema de agua desbordante. Consta de una pieza que se remata por un lado con una serie de listones de forma especial, para ofrecer un desbordamiento y retención del agua óptimos, así como un excelente asidero manual. La flexibilidad de diseño de esta pieza permite realizar bordes con varios materiales de Florim, seleccionados entre las series que presentan las más altas propiedades antideslizantes con pies descalzos (clase A+B+C, ref. norma DIN 51097). Esta pieza especial también incluye la pieza angular de porcelánico de apoyo y sujeción de la rejilla.



FLORIM OVERSIZE
magnUm[®]

IMBALLI E DECORI

PACKAGING AND DECORATIONS
EMBALLAGES ET DÉCORS
VERPACKUNGEN UND DEKORS
EMBALAJES Y DECORACIONES

TABELLA IMBALLI

PACKAGE TABLE/TABLEAU DE EMBALLAGES/TABELLE FORMATE/TABLA DE LOS EMBALAJES
#6 SPESSORE / THICKNESS/ÉPAISSEUR/STÄRKE/ESPESOR

			BOXES 				PALLET 		
			ML	PZ	MQ	KG	BOX	MQ	KG
	80x80	31 ^{1/2} "x31 ^{1/2} "	-	3	1,92	27,80	40	76,80	1140
	60x120	23 ^{5/8} "x47 ^{1/4} "	-	3	2,16	31,30	30	64,80	960
MOSAICO 1,5x3	30x30	11 ^{4/5} "x11 ^{4/5} "	-	11	1,00	16,50	-	-	-
MOSAICO 7,5x7,5	30x30	11 ^{4/5} "x11 ^{4/5} "	-	11	1,00	16,50	-	-	-
MURETTO 7,5x15	30x30	11 ^{4/5} "x11 ^{4/5} "	-	11	1,00	16,50	-	-	-
BATTISCOPIA	4,6x80	1 ^{4/5} "x31 ^{1/2} "	14,40	18	-	8,60	-	-	-
	4,6x60	1 ^{4/5} "x23 ^{5/8} "	14,40	24	-	8,60	-	-	-

DECORI/ DECORS

Note Imballo. Tutti i singoli pezzi tagliati vengono numerati con applicazione sulla parte a vista di un pezzo di nastro isolante dove è riportato il n° del pezzo. Le scatole sono rivestite internamente di polistirolo per garantire l'integrità dei singoli pezzi. Su ogni scatola è riportato: N° dei pezzi totali - Numerazione di ciascun pezzo. Sulla paletta viene applicata una pallet card ed una busta in plastica contenente lo schema di montaggio. Per richieste di formati inferiori al modulo base (120x240 o 160x240), resta in vigore la richiesta di lavorazioni fuori standard. N. B. Il prezzo di listino del decoro si riferisce a formato standard. Eventuali lavorazioni su misura verranno valutate su richiesta. (Il servizio clienti è a disposizione per informazioni e ulteriori dettagli a riguardo).

Packing notes. Each individual cut piece is given a number. The piece number is shown on the exposed side of a strip of insulation tape. The boxes are padded on the inside with polystyrene to protect the individual pieces. Each box bears the following information: Total n° of pieces - Code number of each piece. The pallet comes with a pallet card and a plastic pouch containing the assembly diagram. For smaller sizes requests different from basic modules (120x240 or 160x240), you need to follow the procedure for requesting a non-standard format. N. B. The decor's price list refers to the standard format featuring one colour. Any custom-work will be assessed upon request. Please call our Customer Service for more information.

Remarques concernant l'emballage. Chaque pièce découpée est numérotée avec une application sur la partie visible d'un morceau de ruban isolant sur lequel figure le n° de la pièce. Les boîtes sont revêtues intérieurement de polystyrène afin de garantir l'intégrité de chaque pièce. Sur chaque boîte figurent: le nombre de pièces totales et la numérotation de chaque pièce. Une carte de la palette et un sachet en plastique contenant le schéma du montage sont appliqués sur la palette. Pour toute demande de formats inférieurs au module de base (120x240 ou 160x240), reste en vigueur la demande de hors standard. N. B. Le prix catalogue du décor se réfère au format standard. Les éventuels traitements sur mesure seront évalués sur demande. Le service clientèle est à votre disposition si vous avez besoin d'informations et de plus amples détails.

Verpackungshinweise. Alle geschnittenen einzelnen Teile werden nummeriert, wobei die Nummer des Teils auf der sichtbaren Seite eines Stücks Isolierband angebracht ist. Die Kartonverpackungen sind innen mit Polystyrol ausgelegt, um die Unversehrtheit der einzelnen Teile zu gewährleisten. Folgende Angaben befinden sich auf jedem Karton: Gesamtzahl der Teile Nummerierung jedes Teils. An der Palette sind eine Palettenkarte und ein Kunststoffbeutel mit dem Montageplan angebracht. Für Anfragen von kleineren Formaten als vom Standard vorgesehen (120x240 oder 160x240) gilt der übliche Bearbeitungsvorgang für Sonderanfertigungen. N. B. Der Listenpreis bezieht sich auf die Dekoration im Standard-Format, einfarbig. Eventuelle kundenspezifische Verarbeitungen werden auf Anfrage kalkuliert. Der Kundenservice steht für weitere Informationen und Einzelheiten hierzu jederzeit zur Verfügung.

Notas sobre el embalaje. Todas las partes cortadas se enumeran colocando en la parte a la vista de la pieza una cinta adhesiva donde se reproduce el n.º de la pieza. El interior de las cajas se reviste con poliestireno para garantizar la integridad de cada una de las piezas. Sobre cada caja se reproduce: N.º de las piezas totales - Numeración de cada pieza. En la paleta se coloca una "pallet card" y una bolsa plástica que contiene el esquema del montaje. Para pedidos de formatos inferiores a los módulos de base (120x240 o 160x240), es necesario solicitar las elaboraciones no estándar. N. B. El precio de catálogo del decoro se refiere al formato estándar. Las elaboraciones a medida se evaluarán bajo pedido. El servicio de atención al cliente está a su disposición para proporcionarle más información y detalles al respecto.

Listino IMBALLI / Price List PACKAGING	
TIPO / TYPE	PREZZO / PRICE
A: CASSA / CRATE cm 175x340x31h - 68 ^{8/9} "x133 ^{6/7} "x12 ^{1/5} "	230,00 €
B: CASSA / CRATE cm 145x292x35h - 57"x115"x13 ^{7/9} "	160,00 €
C: CASSA / CRATE cm 136x263x34h - 53 ^{1/2} "x103 ^{1/2} "x13 ^{2/5} "	160,00 €
D: CASSA / CRATE cm 135x144x41h - 53 ^{1/7} "x56 ^{2/3} "x16 ^{1/7} "	-
E: CASSA / CRATE cm 135x144x66h - 53 ^{1/7} "x56 ^{2/3} "x26"	-
G: CASSA / CRATE cm 174x183x41h - 68 ^{1/2} "x72x16 ^{1/7} "	160,00 €
H/I: CAVALLETTO / A-FRAME cm 73x330x200h - 28 ^{3/4} "x130"x78 ^{3/4} "	360,00 €
L: CAVALLETTO / A-FRAME cm 75x339x186h - 29 ^{1/2} "x133 ^{1/2} "x73 ^{2/9} "	500,00 €
M: CAVALLETTO / A-FRAME cm 75x290x146h - 29 ^{1/2} "x114 ^{1/6} "x57 ^{1/2} "	450,00 €
N: CAVALLETTO / A-FRAME cm 75x250x146h - 29 ^{1/2} "x98 ^{3/7} "x57 ^{1/2} "	380,00 €
P: CAVALLETTO / A-FRAME cm 75x250x160h - 29 ^{1/2} "x98 ^{3/7} "x63"	280,00 €
R: CAVALLETTO / A-FRAME cm 75x170x195h - 29 ^{1/2} "x67"x76 ^{7/9} "	280,00 €

*Le lastre sono contenute in scatole da 2 pezzi ciascuna / Packing for this item is 2 slabs per box / Les plaques sont contenues dans des boîtes de 2 pièces chacune. Die Platten sind in Kartons zu je 2 Stück verpackt. / Las baldosas están empaquetadas en cajas de 2 piezas cada una.

°per spedizioni > 12 scatole / for shipments > 12 boxes / pour les expéditions > 12 boîtes / für Versandmengen > 12 Schachteln / para envíos > 12 cajas

°°per spedizioni ≤ 12 scatole / for shipments ≤ 12 boxes / pour les expéditions ≤ 12 boîtes / für Versandmengen ≤ 12 Schachteln / para envíos ≤ 12 cajas

TABELLA IMBALLI

PACKAGE TABLE/TABLEAU DE EMBALLAGES/TABELLE FORMATE/TABLA DE LOS EMBALAJES

≠6 SPESSORE / THICKNESS/ÉPAISSEUR/STÄRKE/ESPEJOR

TIPO TYPE	formato LASTRA SLAB size	LASTRA SLAB		CASSA vuota empty CRATE			CASSA piena full CRATE	CAVALLETTO vuoto empty A-Frame			CAVALLETTO pieno full A-Frame
		MQ	KG	PZ	MQ	KG	KG	PZ	MQ	KG	KG
	A 160x320 63"x126"	5,12	74,15	14	71,68	140,5	1178,6	-	-	-	-
	B 120x280 47 1/4"x110 1/4"	3,36	48,65	20	67,20	90,00	1063	-	-	-	-
	C 120x240 47 1/4"x94 1/2"	2,88	41,70	20	57,60	107,00	941	-	-	-	-
	D 120x120 47 1/4"x47 1/4"	1,44	20,85	24*	34,56	50,00	550	-	-	-	-
	E 120x120 47 1/4"x47 1/4"	1,44	20,70	48*	69,12	70	1065,1	-	-	-	-
	G 160x160 63"x63"	2,56	37,06	24	61,44	45,00	934,44	-	-	-	-
	H 160x320 63"x126"	5,12	74,15	-	-	-	-	44	225,28	220,00	3482,6
	I 120x280 47 1/4"x110 1/4"	3,36	48,65	-	-	-	-	44	147,84	220,00	2360,6
	L 160x320 63"x126" Cavalletto in lamiera zincata Zinc-plated sheet A-frame	5,12	74,15	-	-	-	-	44	225,28	120,00	3382,6
	M 120x280 47 1/4"x110 1/4" Cavalletto in lamiera zincata Zinc-plated sheet A-frame	3,36	48,65	-	-	-	-	44	147,84	108,5	2249,1
	N 120x240 47 1/4"x94 1/2" Cavalletto in lamiera zincata Zinc-plated sheet A-frame	2,88	41,70	-	-	-	-	44	126,72	92,5	1941,5
	P 120x240 47 1/4"x94 1/2"	2,88	41,70	-	-	-	-	44	126,72	170,00	2004,8
	R 160x160 63"x63"	2,56	37,07	-	-	-	-	44	112,64	160,00	1791,08

ESEMPI DI PERSONALIZZAZIONE DECORI IN DIMENSIONE 120X240

EXAMPLES OF DECORS CUSTOMIZATIONS 120X240 SIZE

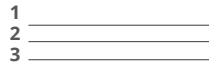
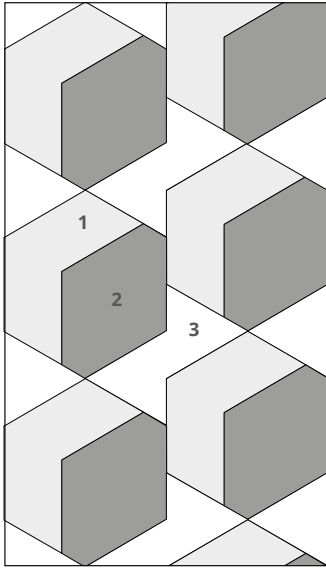

In ogni decoro è possibile selezionare materie e superfici combinandole nel modo in cui si desidera (vedi esempio).
Il decoro può essere adattato a qualsiasi misura richiesta.

For each decor you can select materials and surfaces combining them in the way you prefer (see example).
The decoration can be adapted to any requested measurements.

ABBINAMENTI CONSIGLIATI.

SUGGESTED COMBINATIONS.

STONES&MORE 2.0



CDCA / 749532 ■ FL-58900

1 / STONES&MORE 2.0 / STONE AMANI BRONZE
2 / STONES&MORE 2.0 / STONE MARFIL
3 / STONES&MORE 2.0 / STONE AMANI BRONZE

STONES&MORE 2.0



1 / STONES&MORE 2.0 / STONE CALACATTA

ESEMPI DI PERSONALIZZAZIONE DECORI
EXAMPLES OF DECORS CUSTOMIZATIONS

NEUTRA 6.0

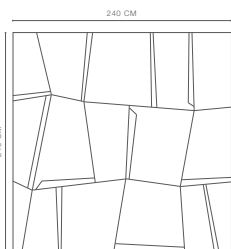
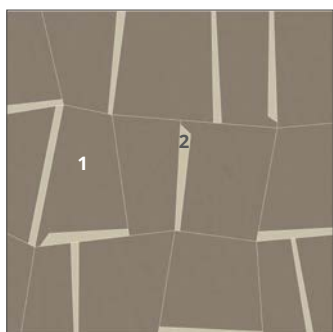

CDCB / 749533 ■ FL-58900

- 1/ NEUTRA 6.0 / 06 GRAFITE
- 2/ NEUTRA 6.0 / 03 PERLA

"STUDIOS"
STONES&MORE 2.0

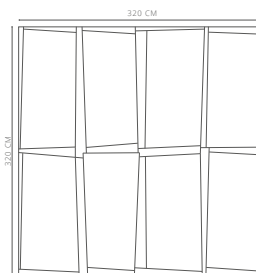
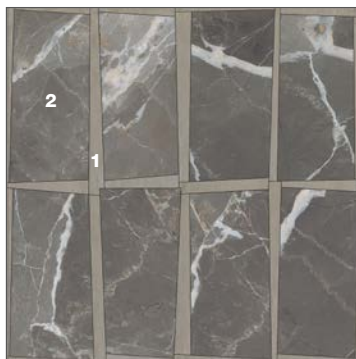

CDCC / 749534 ■ FL-58900

- 1/ "STUDIOS" / CONCRETE
- 2/ STONES&MORE 2.0 / STONE CALACATTA BLACK

STONES&MORE 2.0

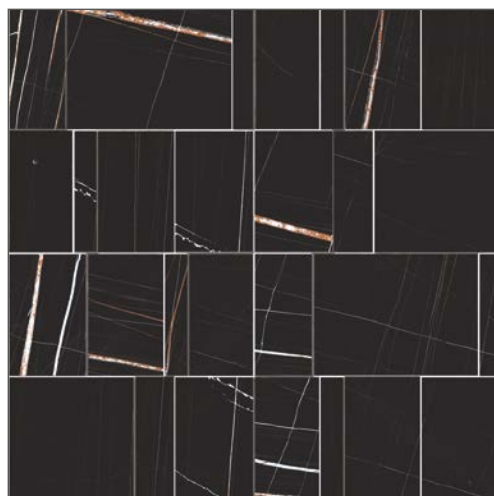

CDCE A/B/C / 750216 ■ FL-58900



CDCE A / 749541 ■ FL-58900

- 1/ STONES&MORE 2.0 / STONE SAHARA NOIR MATTE
- 2/ STONES&MORE 2.0 / STONE SAHARA NOIR GLOSSY

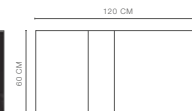

CDCE B / 749542 ■ FL-58900

- 1/ STONES&MORE 2.0 / STONE SAHARA NOIR MATTE
- 2/ STONES&MORE 2.0 / STONE SAHARA NOIR GLOSSY



CDCE C / 749543 ■ FL-58900

- 1/ STONES&MORE 2.0 / STONE SAHARA NOIR MATTE
- 2/ STONES&MORE 2.0 / STONE SAHARA NOIR GLOSSY

ESEMPI DI PERSONALIZZAZIONE DECORI IN DIMENSIONE 160X240

EXAMPLES OF DECORS CUSTOMIZATIONS 160X240 SIZE

NEUTRA 6.0



CDCD A/B/C/D/E/F
749532 ■ FL-58900

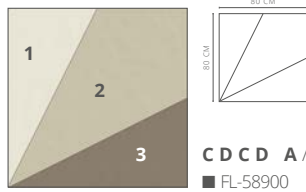

CDCD A / 749535
■ FL-58900

- 1/ NEUTRA 6.0 / 01 BIANCO
- 2/ NEUTRA 6.0 / 04 FERRO
- 3/ NEUTRA 6.0 / 06 GRAFITE

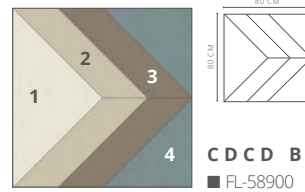

CDCD B / 749536
■ FL-58900

- 1/ NEUTRA 6.0 / 01 BIANCO
- 2/ NEUTRA 6.0 / 04 FERRO
- 3/ NEUTRA 6.0 / 06 GRAFITE
- 4/ NEUTRA 6.0 / 08 AVIO

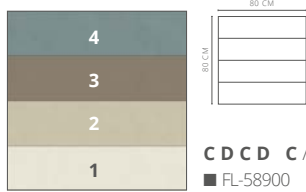

CDCD C / 749537
■ FL-58900

- 1/ NEUTRA 6.0 / 01 BIANCO
- 2/ NEUTRA 6.0 / 04 FERRO
- 3/ NEUTRA 6.0 / 06 GRAFITE
- 4/ NEUTRA 6.0 / 08 AVIO

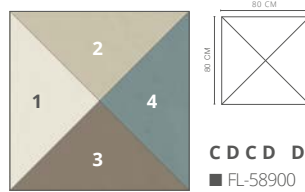

CDCD D / 749538
■ FL-58900

- 1/ NEUTRA 6.0 / 01 BIANCO
- 2/ NEUTRA 6.0 / 04 FERRO
- 3/ NEUTRA 6.0 / 06 GRAFITE
- 4/ NEUTRA 6.0 / 08 AVIO



CDCD E / 749539
■ FL-58900

- 1/ NEUTRA 6.0 / 01 BIANCO
- 2/ NEUTRA 6.0 / 04 FERRO
- 3/ NEUTRA 6.0 / 06 GRAFITE
- 4/ NEUTRA 6.0 / 08 AVIO



CDCD F / 749540
■ FL-58900

- 1/ NEUTRA 6.0 / 01 BIANCO
- 2/ NEUTRA 6.0 / 04 FERRO
- 3/ NEUTRA 6.0 / 06 GRAFITE
- 4/ NEUTRA 6.0 / 08 AVIO

ESEMPI DI PERSONALIZZAZIONE DECORI IN DIMENSIONE 120X240

EXAMPLES OF DECORS CUSTOMIZATIONS 120X240 SIZE

STONES&MORE 2.0



CDCF / 749544 ■ FL-58900

STONES&MORE 2.0 / STONE CALACATTA BLACK

STONES&MORE 2.0



CDCG / 749545 ■ FL-58900

**1/ STONES&MORE 2.0 / STONE CALACATTA
2/ STONES&MORE 2.0 / STONE SAHARA NOIR**

NEUTRA 6.0

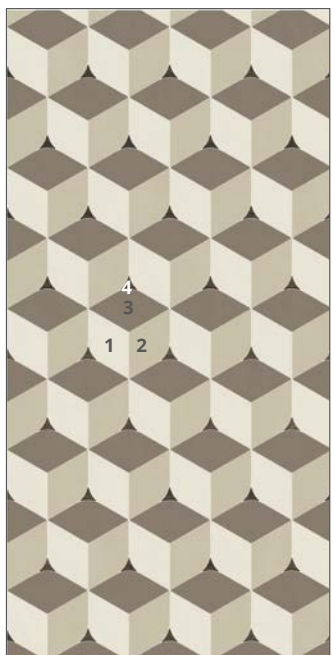

CDCH / 749546 ■ FL-58900

**1/ "STUDIOS" / CHALK
2/ NEUTRA 6.0 / 03 PERLA
3/ NEUTRA 6.0 / 06 GRAFITE
4/ NEUTRA 6.0 / 06 GRAFITE**

STONES&MORE 2.0



CDCI / 749547 ■ FL-58900

STONES&MORE 2.0 / STONE CALACATTA

ESEMPI DI PERSONALIZZAZIONE DECORI IN DIMENSIONE 120X240

EXAMPLES OF DECORS CUSTOMIZATIONS 120X240 SIZE

STONES&MORE 2.0

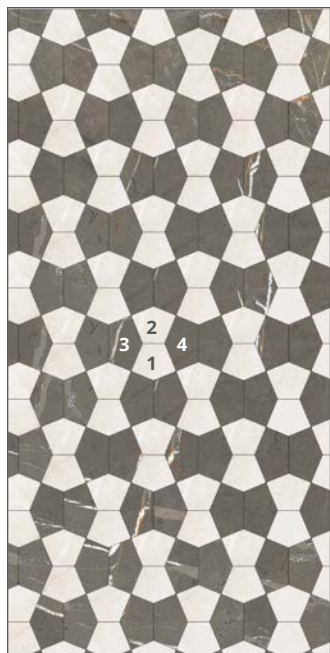

CDCL / 749548 ■ FL-58900

- 1/ STONES&MORE 2.0 / STONE MARFIL
- 2/ STONES&MORE 2.0 / STONE MARFIL
- 3/ STONES&MORE 2.0 / AMANI BRONZE
- 4/ STONES&MORE 2.0 / AMANI BRONZE

"STUDIOS"

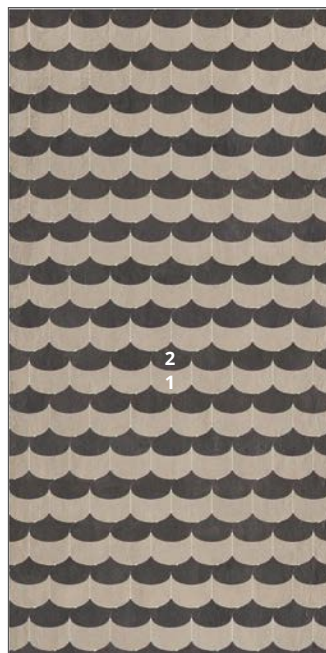

CDCM / 749549 ■ FL-58900

- 1/ "STUDIOS" / SAND
- 2/ "STUDIOS" / RUBBER

NEUTRA 6.0

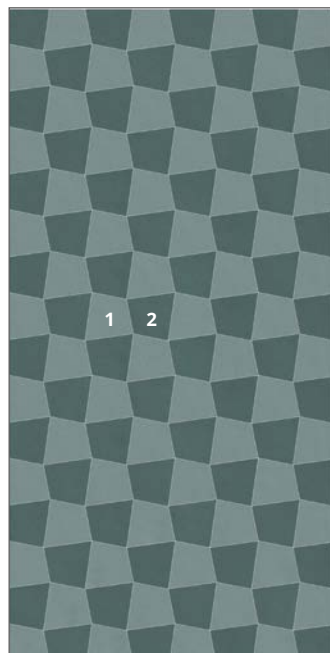

CDCN / 749550 ■ FL-58900

- 1/ NEUTRA 6.0 / 08 AVIO
- 2/ NEUTRA 6.0 / 07 PETROLIO

NEUTRA 6.0

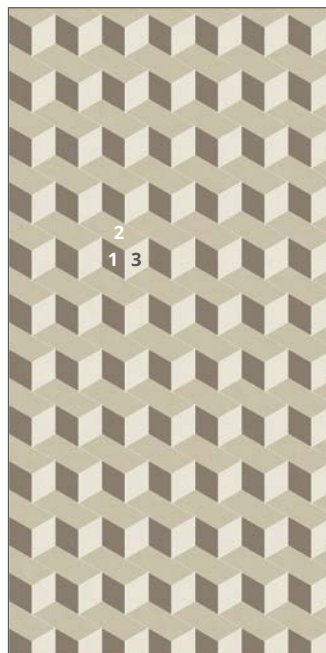

CDCO / 749551 ■ FL-58900

- 1/ NEUTRA 6.0 / 06 GRAFITE
- 2/ NEUTRA 6.0 / 04 FERRO
- 3/ NEUTRA 6.0 / 01 BIANCO

ESEMPI DI PERSONALIZZAZIONE DECORI IN DIMENSIONE 120X240

EXAMPLES OF DECORS CUSTOMIZATIONS 120X240 SIZE

STONES&MORE 2.0



CDCP / 749552 ■ FL-58900

- 1/ STONES&MORE 2.0 / AMANI BRONZE
- 2/ STONES&MORE 2.0 / AMANI BRONZE
- 3/ STONES&MORE 2.0 / STONE MARFIL
- 4/ STONES&MORE 2.0 / STONE MARFIL

ESEMPI DI PERSONALIZZAZIONE DECORI IN DIMENSIONE 265X240

EXAMPLES OF DECORS CUSTOMIZATIONS 265X240 SIZE

NEUTRA 6.0

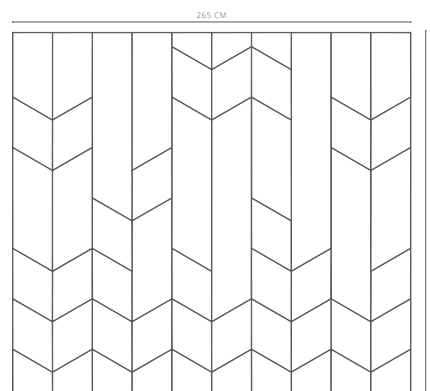
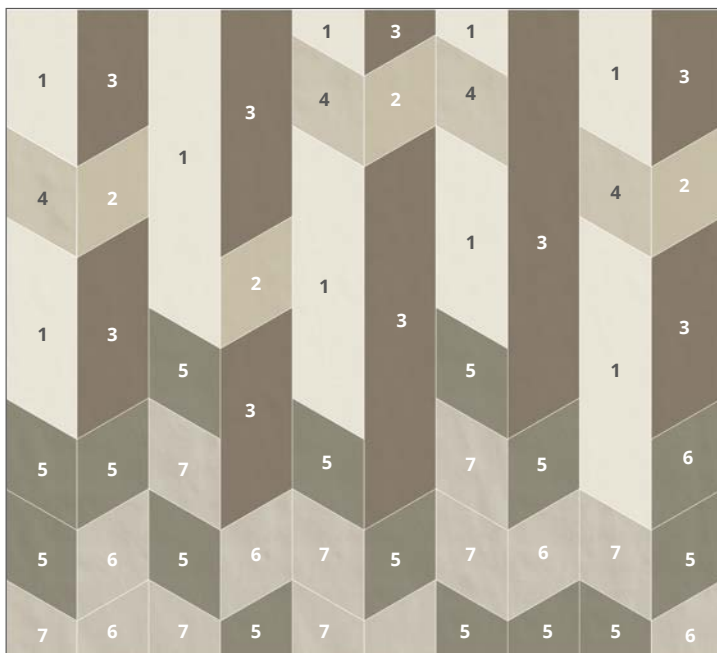

CDCQ / 749553 ■ FL-58900

- 1/ NEUTRA 6.0 / 01 BIANCO
- 2/ NEUTRA 6.0 / 04 FERRO
- 3/ NEUTRA 6.0 / 06 GRAFITE
- 4/ NEUTRA 6.0 / 02 POLVERE
- 5/ NEUTRA 6.0 / 05 QUARZO
- 6/ NEUTRA 6.0 / 03 PERLA
- 7/ NEUTRA 6.0 / 03 PERLA

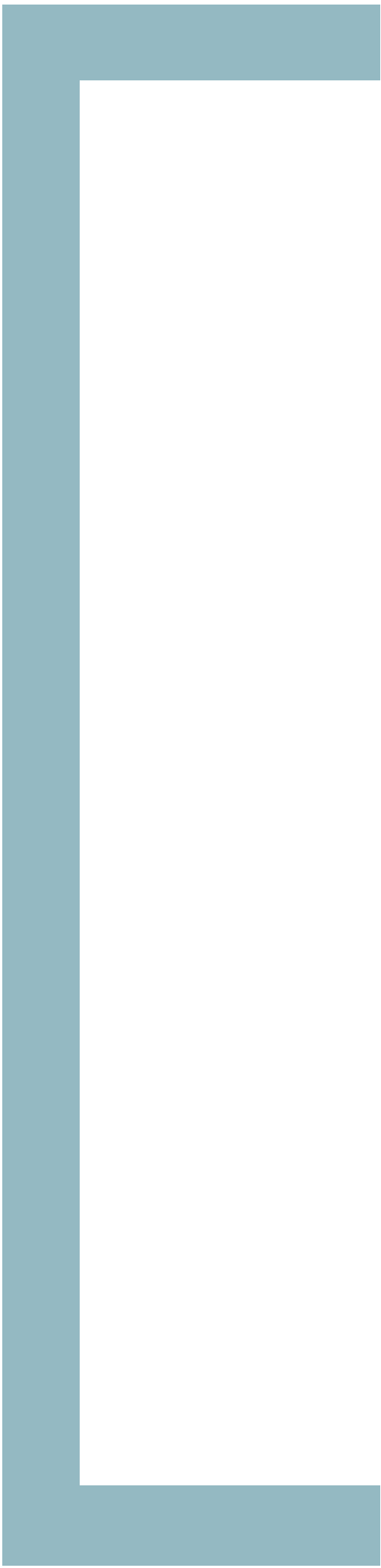

FLORIM OVERSIZE
magnUm[®]

MODERN DESIGN
PERSPECTIVES ARE
CHANGING: AMAZING
SIZES IN A THICKNESS
OF JUST 6 MM,
LIGHT, VERSATILE
AND STRONG, WITH
EXTRAORDINARY
AESTHETIC APPEAL.

GRAPHICS

GLACIER



TUNDRA



RAINFOREST

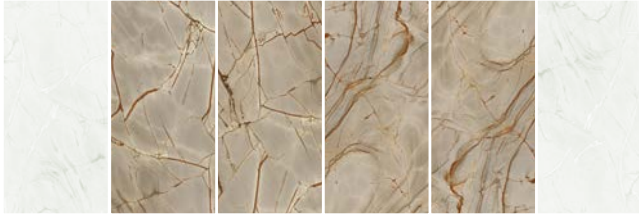

MOUNTAIN PEAK



RIVERBED

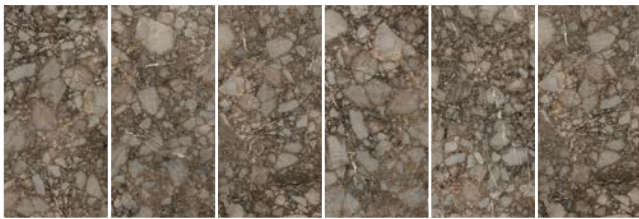

NATURE MOOD

PLANK_01



PLANK_04



PLANK_02



PLANK_05



PLANK_03

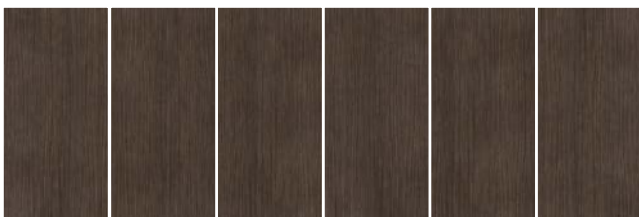

PLANK_06



NATURE MOOD

Le immagini riportate non rappresentano necessariamente il numero di grafiche del prodotto. Il numero di grafiche è variabile in funzione del formato e del colore di riferimento. Images do not necessarily represent the number of patterns in the product's range. The number of different patterns varies according to size and color of the item. / Les images reportées ne représentent pas forcément le nombre de graphismes du produit. Leur nombre varie en fonction du format et de la couleur choisie. / Die Abbildungen geben keine bindende Auskunft bzgl. der Anzahl verschiedener Grafiken. Die Anzahl der Grafiken ist abhängig von Format und Farbe der jeweiligen Kollektion. / Las imágenes mostradas no representan necesariamente el número de gráficas del producto. El número de gráficas varía en función del formato y del color.

WHITE ONYX



GOLDEN ONYX



WHITE BLEND



GOLDEN BLEND

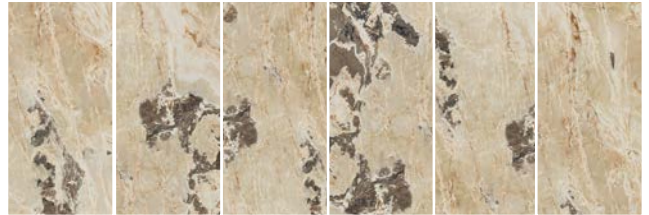

WHITE PORPHYRY



GOLDEN PORPHYRY

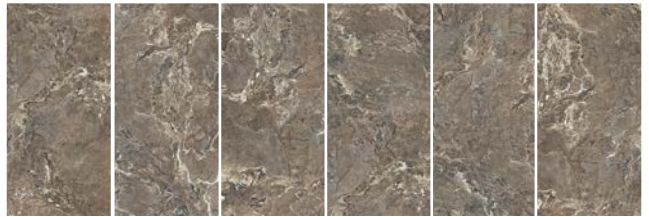

SILVER ONYX



SILVER BLEND

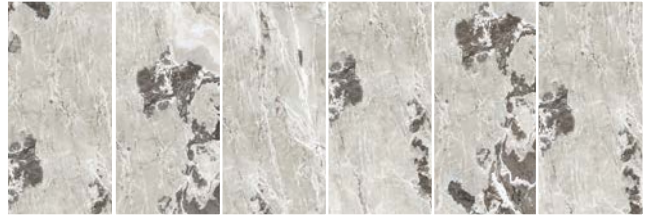

SILVER PORPHYRY



ONYX&MORE

DUST WHITE



SAND WHITE



LITHOS WHITE



FOSSIL WHITE



DUST IVORY



SAND IVORY



LITHOS IVORY



FOSSIL IVORY



DUST GREY



SAND GREY



LITHOS GREY



FOSSIL GREY



Le immagini riportate non rappresentano necessariamente il numero di grafiche del prodotto. Il numero di grafiche è variabile in funzione del formato e del colore di riferimento.
 Images do not necessarily represent the number of patterns in the product's range. The number of different patterns varies according to size and color of the item. / Les images reportées ne représentent pas forcément le nombre de graphismes du produit. Leur nombre varie en fonction du format et de la couleur choisie. / Die Abbildungen geben keine bindende Auskunft bzgl. der Anzahl verschiedener Grafiken. Die Anzahl der Grafiken ist abhängig von Format und Farbe der jeweiligen Kollektion. / Las imágenes mostradas no representan necesariamente el número de gráficas del producto. El número de gráficas varía en función del formato y del color.

DUST TAUPE



SAND TAUPE



LITHOS TAUPE



FOSSIL TAUPE



DUST BROWN



SAND BROWN



LITHOS BROWN



FOSSIL BROWN

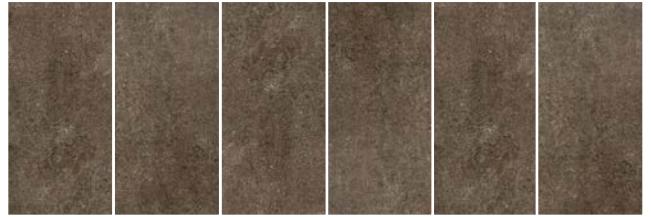

STONE MARFIL



STONE CALACATTA



ARABESCATO WHITE



STONE CALACATTA BLACK

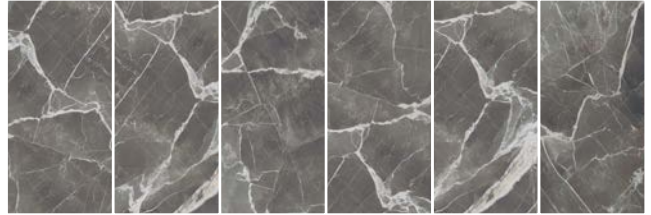

AMANI BRONZE



STONE SAHARA NOIR



CHALK



SAND



CLOUD



CONCRETE



RUBBER

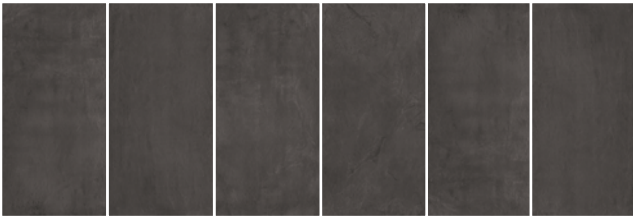

01 BIANCO

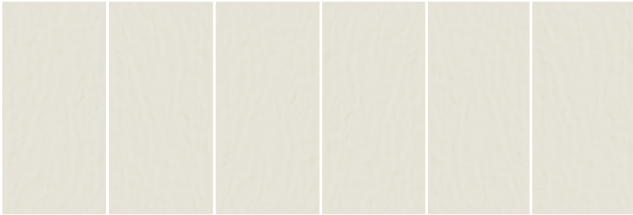

02 POLVERE



03 PERLA



04 FERRO



05 QUARZO

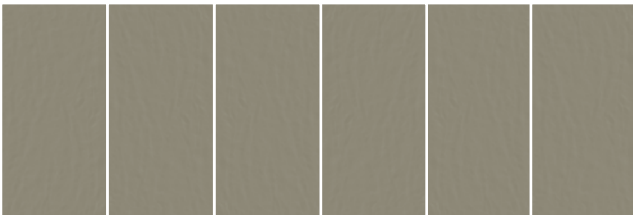

06 GRAFITE

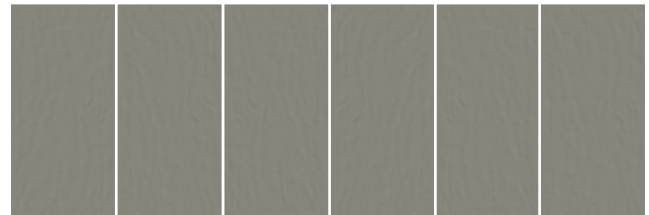

Le immagini riportate non rappresentano necessariamente il numero di grafiche del prodotto. Il numero di grafiche è variabile in funzione del formato e del colore di riferimento.
 Images do not necessarily represent the number of patterns in the product's range. The number of different patterns varies according to size and color of the item. / Les images reportées ne représentent pas forcément le nombre de graphismes du produit. Leur nombre varie en fonction du format et de la couleur choisie. / Die Abbildungen geben keine bindende Auskunft bzgl. der Anzahl verschiedener Grafiken. Die Anzahl der Grafiken ist abhängig von Format und Farbe der jeweiligen Kollektion. / Las imágenes mostradas no representan necesariamente el número de gráficas del producto. El número de gráficas varía en función del formato y del color.

NEUTRA 6.0

07 PETROLIO



08 AVIO



09 OLIVA



10 ACQUAMARINA

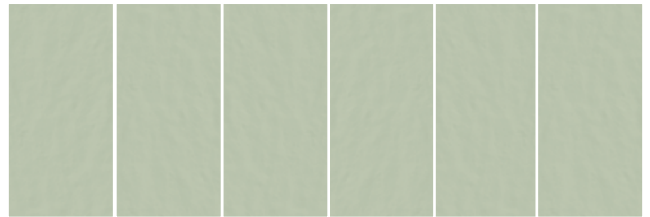

11 MELANZANA



12 MALVA

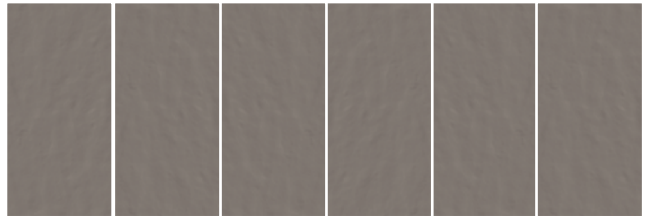

13 CORALLO

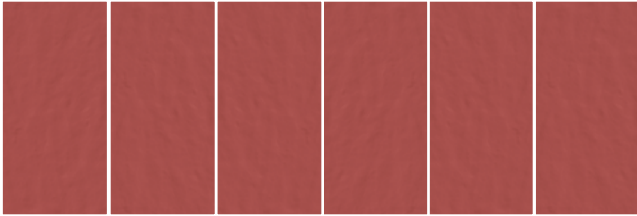

14 ARANCIO

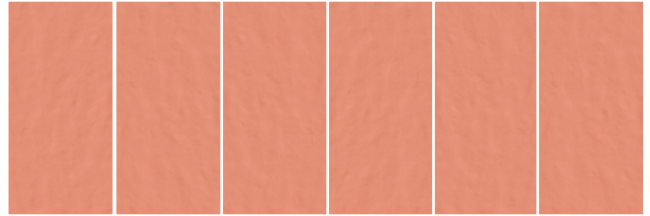

URBAN STYLE

URBAN LIGHT



URBAN PLOMB



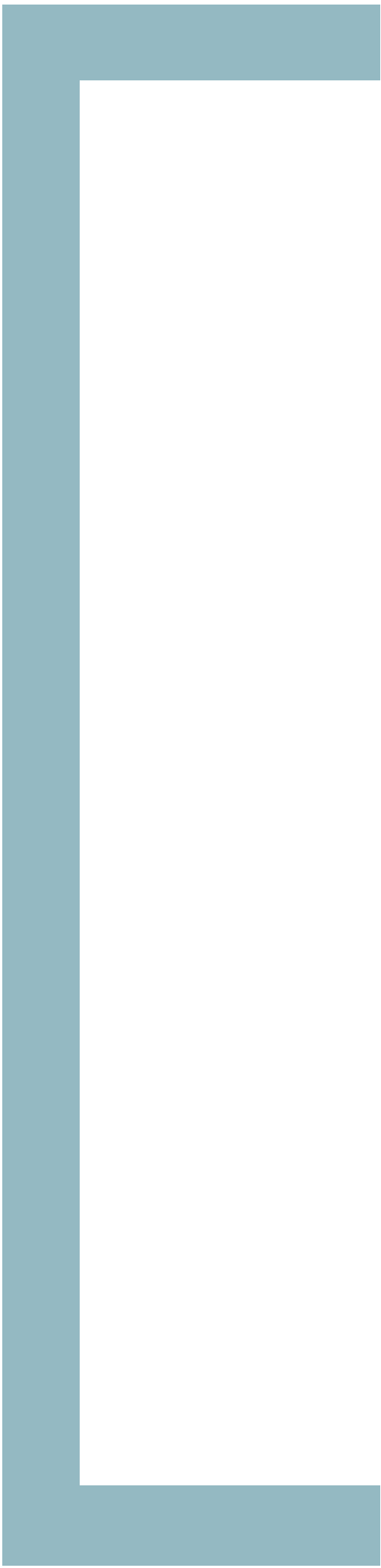

CARATTERISTICHE TECNICHE

TECHNICAL FEATURES
CARACTÉRISTIQUES TECHNIQUES
TECHNISCHE EIGENSCHAFTEN
CARACTERISTICAS TÉCNICAS

6mm

CARATTERISTICHE TECNICHE - TECHNICAL CHARACTERISTICS - CARACTERISTIQUES TECHNIQUES - TECHNISCHE EIGENSCHAFTEN - CARACTERÍSTICAS TÉCNICAS							
Lastre in gres fine porcellanato non smaltato. Piastrelle di ceramica pressate a secco. Caratteristiche di qualità secondo i test di controllo previsti dalla norma EN 14411-ISO 13006 Appendice G gruppo Bla UGL. / Unglaziert porcelain stoneware slabs. Dry-pressed ceramic tiles. Quality specifications, according to control tests of EN 14411-ISO 13006 Appendix G group Bla UGL. / Dalles en gres cérame fin non émailé. Carreaux céramiques pressés à sec. Caractéristiques de qualité d'après les essais de contrôle norme EN 14411-ISO 13006 Appendice G groupe B1a UGL. / Nicht glasierte und vollstündig gesinterte Feinsteinzeugplatten. Trocken gepresste Keramikfliesen. Qualitätseigenschaften nach Normen EN 14411-ISO 13006 Anhang G Gruppe Bla UGL. / Planchas de gres porcelánico fino no esmaltado. Baldosas de cerámica rensadas en seco. Características de calidad según las Normas EN 14411-ISO 13006 Apéndice G grupo Bla UGL.		PRESCRIZIONE STANDARD REQUIREMENTS PRESCRIPTIONS ANFORDERUNGEN PRESCRIPCION		RISULTATI TESTS TEST RESULTS RESULTATS DES ESSAIS PRÜFERGEBNIS RESULTADOS TESTS			RIFERIMENTO NORMA REFERENCE STANDARD STANDARDWERT REFERENCIA NORMA
		N ≥ 15 cm		N ≥ 15 cm			
		(%)	(mm)	satin	strutturato	glossy	
	LUNGHEZZA E LARGHEZZA: DEVIAZIONE AMMISSIBILE, IN %, DELLA DIMENSIONE MEDIA DI OGNI PIASTRELLA DALLA DIM. DI FABBRICAZIONE / LENGTH AND WIDTH: ADMITTED DEVIATION, IN %, OF THE AVERAGE SIZE OF EACH TILE FROM THE PRODUCTION DIMENSIONS / LONGUEUR ET LARGEUR: MARGE DE TOLERANCE, EN %, ENTRE LA DIMENSION MOYENNE DE CHAQUE CARREAU ET LA DIM. DE FABRICATION / LANGE UND BREITE: ZULASSIGE ABWEICHUNG DES DURCHSCHNITTMÄßES JEDER FLIESE VOM HERSTELLMAß IN PROZENTEN / LARGO Y ANCHO: DESVIACION ADMISIBLE, EN %, DEL TAMAÑO MEDIO DE CADA BALDOSA A PARTIR DEL TAMAÑO DE FABRICACION.	Squadrato ISO 13006	±0,3%	±1,0mm		±0,15%	ISO 10545-2
	DEVIAZIONE AMMISSIBILE, IN PERCENTO, DELLO SPESSORE MEDIO DI OGNI PIASTRELLA DALLA DIMENSIONE DI FABBRICAZIONE / ADMITTED DEVIATION, IN %, OF THE AVERAGE THICKNESS OF EACH TILE FROM THE PRODUCTION DIMENSIONS / MARGE DE TOLERANCE, EN POURCENTAGE, ENTRE L'ÉPAISSEUR MOYENNE DE CHAQUE CARREAU ET LA DIMENSION DE FABRICATION / ZULASSIGE ABWEICHUNG DER DURCHSCHNITTSDICKE JEDER FLIESE VOM HERSTELLMAß IN PROZENTEN / DESVIACION ADMISIBLE, EN TANTO POR CIENTO, DEL GROSOR MEDIO DE CADA BALDOSA A PARTIR DEL TAMAÑO DE FABRICACION.	-	±5%	±0,5mm		±5%	ISO 10545-2
	DEVIAZIONE MASSIMA DI RETTILINEARITÀ, IN PERCENTO, IN RAPPORTO ALLE DIMENSIONI DI FABBRICAZIONE CORRISPONDENTI / MAXIMUM STRAIGHTNESS DEVIATION, IN %, IN RELATION TO THE CORRESPONDING PRODUCTION DIMENSIONS / MARGE DE TOLERANCE DE RECTITUDE, EN POURCENTAGE, PAR RAPPORT AUX DIMENSIONS DE FABRICATION CORRESPONDANTES / ZULASSIGE HÖCHSTABWEICHUNG DER KANTENGERADHEIT IM VERHÄLTNIß ZU DEN ENTSPRECHENDEN HERSTELLMAßEN IN PROZENTEN / DESVIACIÓN MÁXIMA DE RECTITUD, EN TANTO POR CIENTO, EN RELACIÓN CON EL TAMAÑO DE FABRICACIÓN CORRESPONDIENTE.	Squadrato ISO 13006	±0,3%	±0,8mm		±0,10%	ISO 10545-2
	DEVIAZIONE MASSIMA DI ORTOGONALITÀ, IN PERCENTO, IN RAPPORTO ALLE DIMENSIONI DI FABBRICAZIONE CORRISPONDENTI MAXIMUM RIGHT-ANGLE DEVIATION, IN %, IN RELATION TO THE CORRESPONDING PRODUCTION DIMENSIONS / MARGE DE TOLERANCE D'ANGULARITÉ, EN POURCENTAGE, PAR RAPPORT AUX DIMENSIONS DE FABRICATION / HÖCHSTABWEICHUNG DER RECHTWINKLIGKEIT IM VERHÄLTNIß ZU DEN ENTSPRECHENDEN HERSTELLMAßEN IN PROZENTEN / DESVIACIÓN MÁXIMA DE LA ORTOGONALIDAD, EN TANTO POR CIENTO, EN RELACIÓN CON EL TAMAÑO DE FABRICACIÓN CORRESPONDIENTE.	Squadrato ISO 13006	±0,3%	±1,5mm		±0,20%	ISO 10545-2
	PLANARITÀ (CURVATURA DEL CENTRO, DELLO SPINGOLO E SVERGOLAMENTO) / FLATNESS (CURVING IN THE MIDDLE CORNER AND WARPING) / PLANÉITÉ (COURBURE CENTRALE, DE L'ARÊTE ET GAUCHISSEMENT) / EBENFLÄCHIGKEIT (KRÜMMUNG DER MITTE, DER KANTE UND VERWINDUNG) / PLANITUD (CURVATURA DEL CENTRO, DE LA ARISTA Y ABARQUILLAMIENTO).	Squadrato ISO 13006	±0,4%	±1,8mm		±0,20%	ISO 10545-2
QUALITÀ DELLA SUPERFICIE / SURFACE QUALITY / QUALITÉ DE LA SURFACE / QUALITÄT DER OBERFLÄCHE / CALIDAD DE LA SUPERFICIE.					CONFORME/CONFORMING CONFORME/CONFORM CONFORME	ISO 10545-2	
	MASSA D'ACQUA ASSORBITA IN % / % WATER ABSORPTION - MASSE D'EAU ABSORBÉE EN % / WASSERAUFNAHME IN % / MASA DE AGUA ABSORBIDA EN %		< 0,5%			valore medio 0,08%	ISO 10545-3
	FORZA DI ROTTURA IN N (sp. < 7,5 mm) - BREAKING STRENGTH IN N (thickness < 7,5 mm) / FORCE DE RUPTURE EN N (ép. < 7,5 mm) / BRUCHLAST IN N (Dicke < 7,5 mm) / FUERZA DE ROTURA EN N (gr. < 7,5 mm).		≥ 700			valore medio 1350 Newton	ISO 10545-4
	RESISTENZA ALLA FLESSIONE IN N/mm2 / N/mm2 FLEXURAL STRENGTH TEST / RESISTANCE A LA FLEXION EN N/mm2 / BIEGEFESTIGKEIT IN N/mm2 / RESISTENCIA A LA FLEXIÓN EN N/mm2		35 MIN.			valore medio 52 N/mm2	ISO 10545-4
	RESISTENZA ALL'ABRAZIONE PROFONDA DELLE PIASTRELLE NON SMALTATE / RESISTANCE TO DEEP ABRASION OF UNGLAZED TILES / RESISTENCIA A LABRACION PROFUNDA DES CARREAUX NON ÉMAILÉS / TIEFENABRIEBFÄHIGKEIT UNGLASIERTE FLIESEN / RESISTENCIA A LA ABRASION PROFUNDA DE LAS BALDOSAS SIN ESMALTAR.		< 175 mm ³			valore medio 140 mm ³	ISO 10545-6
	RESISTENZA AGLI SBALZI TERMICI / THERMAL SHOCKS RESISTANT / RESISTANCE AUX VARIATIONS THERMIQUES / TEMPERATURWECHSELBESTÄNDIGKEIT / RESISTENCIA AL CHOQUE TERMICO.		Metodo di prova disponibile / Available testing method Méthode d'essai disponible / Verfügbare Prüfmethode Método de ensayo disponible			RESISTE - RÉSISTANT RESISTE - ERFÜLLT RESISTE	ISO 10545-9
	RESISTENZA AL GELO / FROST RESISTANCE / RESISTANCE AU GEL / FROSTSICHERHEIT RESISTENCIA A LA HELADA		RICHIESTA - REQUIRED REQUIRE - GEFORDERT REQUERIDA			RESISTE - RÉSISTANT RESISTE - ERFÜLLT RESISTE	ISO 10545-12
	RESISTENZA ALLE MACCHIE / RESISTANCE TO STAINING / RESISTANCE AUX TACHES / FLECKENABWEISEND / RESISTENCIA A LAS MANCHAS.		Metodo di prova disponibile / Available testing method Méthode d'essai disponible / Verfügbare Prüfmethode Método de ensayo disponible	Classe 4-5	Classe 5	Classe 4-5	ISO 10545-14
	RLASCIO DI SOSTANZE PERICOLOSE / RELEASE OF HAZARDOUS SUBSTANCES / REJET DE SUBSTANCES DANGEREUSES / FREISETZUNG GEFÄHRLICHER STOFFE / LIBERACIÓN DE SUSTANCIAS PELIGROSAS / CADMIO (in mg/dm ²) - PIOMBO (in mg/dm ²)		VALORE DICHIARATO PER SUPERFICIE GL CON IMPREGHI SU PAVI DI LAVORO / DECLARÉD VALLE FOR GL SURFACES USED ON WORKTOPS / VALEUR DÉCLARÉE POUR SURFACES GL UTILISÉS SUR PLANS DE TRAVAIL / ANGEZEIGENER WERT FÜR GL-OBERFLÄCHEN ZEIM GEBRAUCH ALS ARBEITSPLATTEN / VALOR DECLARADO PARA ACABADOS GL UTILIZADOS PARA SUPERFICIES DE TRABAJO			CONFORME/CONFORMING CONFORME/CONFORM CONFORME	DM-1-2-2007-Reg-CE-1935-2004
	RESISTENZA A BASSE CONCENTRAZIONI DI ACIDI E ALCALI. / RESISTANCE TO LOW CONCENTRATIONS OF ACIDS AND ALKALIS. / RESISTANCE A BASSES CONCENTRATIONS D'ACIDES ET ALCALIS. / WIDERSTAND GEGEN NIEDRIGE KONZENTRATIONEN VON SAUREN UND LAUGEN. / RESISTENCIA A BAJAS CONCENTRACIONES DE ACIDOS Y ALCALIS.		COME DICHIARATO DAL PRODUTTORE SEE MANUFACTURERS DECLARATION SELON DÉCLARATION DU PRODUCTEUR ENTSPRECHEND DER HERSTELLERANGABEN TAL COMO DECLARA EL FABRICANTE	ULA-ULB	ULA	ULA-ULB	ISO 10545-13
	RESISTENZA AI PRODOTTI CHIMICI DI USO DOMESTICO E AGLI ADDITIVI PER PISCINA / RESISTENCE TO DOMESTIC CHEMICAL PRODUCTS AND ADDITIVES FOR SWIMMING POOLS / RESISTANT AUX PRODUITS CHIMIQUES À USAGE DOMESTIQUE ET AUX ADDITIFS POUR PISCINE / WIDERSTAND GEGEN HAUSHALTS-CHEMIKALIEN UND / SCHWIMMBADZUSATZSTOFFEN / RESISTENCIA A PRODUCTOS PARA LIMPIEZA DOMESTICA Y ADITIVOS PARA PISCINAS		MIN B		UA		
	COEFFICIENTE D'ATTRITO (SCIVOLOSITÀ) / FRICTION COEFFICIENT (SLIPPERINESS) / COEFFICIENT DE FRICTION (GLISSEMENT) / REIBUNGSKOEFFIZIENT (SCHLUPFRIGKEIT) / COEFICIENTE DE ANTI DESLIZAMIENTO.		-			10° ≤ α < 19° R10	DIN EN 16165 ANNEX B
			-			18° ≤ α < 24° classe B	DIN EN 16165 ANNEX A
			-	> 0,42 wet		> 0,42 wet	

Per un effetto ottimale della posa, florim suggerisce di mantenere 2 mm di fuga per pose monoformato e 3 mm per combinare formati misti / For optimal installation results, florim recommends maintaining a joint of 2 mm 1/16" for single format installations and 3 mm 1/8" to combine mixed formats / Pour réaliser une pose parfaite, florim suggère de maintenir 2 mm de joint pour la pose des monoformats, et 3 mm pour les combinaisons de formats mixtes / Um einen optimalen effekt beim verlegen zu erzielen empfiehlt florim eine 2 mm fuge bei einformatigen verlegungen und 3 mm fuge bei formatkombinationen / Para lograr los máximos resultados en la posa del producto, florim aconseja 2 mm de junta en aplicaciones monoformato y 3 mm en combinaciones de formatos mixtos.

CARATTERISTICHE TECNICHE - TECHNICAL CHARACTERISTICS - CARACTERISTIQUES TECHNIQUES - TECHNISCHE EIGENSCHAFTEN - CARACTERÍSTICAS TÉCNICAS								
Lastre in gres fine porcellanato non smaltato. Piastrelle di ceramica pressate a secco. Caratteristiche di qualità secondo i test di controllo previsti dalla norma EN 14411-ISO 13006 Appendice G gruppo Bia UGL. / Unglazed porcelain stoneware slabs. Dry-pressed ceramic tiles. Quality specifications, according to control tests of EN 14411-ISO 13006 Appendix G group Bia UGL. / Dalles en gres cérame fin non émaillé. Carreaux céramiques pressés à sec. Caractéristiques de qualité d'après les essais de contrôle norme EN 14411-ISO 13006 Appendice G groupe Bia UGL. / Nicht glasierte und vollständig gesinterte Feinsteinzeugplatten. Trocken gepresste Keramikfliesen. Qualitätseigenschaften nach Normen EN 14411-ISO 13006 Anhang G Gruppe Bia UGL. 7 Planchas de gres porcelánico fino no esmaltado. Baldosas de cerámica rensadas en seco. Características de calidad según las Normas EN 14411-ISO 13006 Apéndice G grupo Bia UGL.		PRESCRIZIONE STANDARD REQUIREMENTS PRESCRIPTIONS ANFORDERUNGEN PRESCRIPCION		RISULTATI TESTS TEST RESULTS RESULTATS DES ESSAIS PRÜFERGEBNIS RESULTADOS TESTS			RIFERIMENTO NORMA REFERENCE STANDARD RÉFÉRENCE NORME STANDARDWERT REFERENCIA NORMA	
		N ≥ 15 cm		matte	bocciardato-matte	R+PTV		
		(%)	(mm)					
	LUNGHEZZA E LARGHEZZA: DEVIAZIONE AMMISSIBILE, IN % DELLA DIMENSIONE MEDIA DI OGNI PIASTRELLA DALLA DIM. DI FABBRICAZIONE / LENGTH AND WIDTH: ADMITTED DEVIATION, IN % OF THE AVERAGE SIZE OF EACH TILE FROM THE PRODUCTION DIMENSIONS / LONGUEUR ET LARGEUR : MARGE DE TOLÉRANCE, EN % ENTRE LA DIMENSION MOYENNE DE CHAQUE CARREAU ET LA DIM. DE FABRICATION / LÄNGE UND BREITE: ZULÄSSIGE ABWEICHUNG DES DURCHSCHNITTMÄßES JEDER FLIESE VOM HERSTELLMAß IN PROZENTEN / LARGO Y ANCHO: DESVIACION ADMISIBLE, EN % DEL TAMAÑO MEDIO DE CADA BALDOSA A PARTIR DEL TAMAÑO DE FABRICACION.	Squadrato ISO 13006	±0,3%	±1,0mm	±0,15%		ISO 10545-2	
	DEVIAZIONE AMMISSIBILE, IN PERCENTO, DELLO SPESORE MEDIO DI OGNI PIASTRELLA DALLA DIMENSIONE DI FABBRICAZIONE / ADMITTED DEVIATION, IN % OF THE AVERAGE THICKNESS OF EACH TILE FROM THE PRODUCTION DIMENSIONS / MARGE DE TOLÉRANCE, EN POURCENTAGE, ENTRE L'ÉPAISSEUR MOYENNE DE CHAQUE CARREAU ET LA DIMENSION DE FABRICATION / ZULÄSSIGE ABWEICHUNG DER DURCHSCHNITTSDICKE JEDER FLIESE VOM HERSTELLMAß IN PROZENTEN / DESVIACION ADMISIBLE, EN TANTO POR CIENTO, DEL GROSOR MEDIO DE CADA BALDOSA A PARTIR DEL TAMAÑO DE FABRICATION.	-	±5%	±0,5mm	±5%		ISO 10545-2	
	DEVIAZIONE MASSIMA DI RETTILINEARITÀ, IN PERCENTO IN RAPPORTO ALLE DIMENSIONI DI FABBRICAZIONE CORRESPONDENTI / MAXIMUM STRAIGHTNESS DEVIATION, IN % IN RELATION TO THE CORRESPONDING PRODUCTION DIMENSIONS / MARGE DE TOLÉRANCE DE RECTITUDE, EN POURCENTAGE, PAR RAPPORT AUX DIMENSIONS DE FABRICATION CORRESPONDANTES / ZULÄSSIGE HOCHSTABWEICHUNG DER KANTENGERADHEIT IM VERHÄLTNIß ZU DEN ENTSPRECHENDEN HERSTELLMAßEN IN PROZENTEN / DESVIACION MÁXIMA DE RECTITUD, EN TANTO POR CIENTO, EN RELACION CON EL TAMAÑO DE FABRICACION CORRESPONDIENTE.	Squadrato ISO 13006	±0,3%	±0,8mm	±0,10%		ISO 10545-2	
	DEVIAZIONE MASSIMA DI ORTOGONALITÀ, IN PERCENTO, IN RAPPORTO ALLE DIMENSIONI DI FABBRICAZIONE CORRESPONDENTI MAXIMUM RIGHT-ANGLE DEVIATION, IN % IN RELATION TO THE CORRESPONDING PRODUCTION DIMENSIONS / MARGE DE TOLÉRANCE D'ANGULARITÉ, EN POURCENTAGE, PAR RAPPORT AUX DIMENSIONS DE FABRICATION / HOCHSTABWEICHUNG DER RECHTHALTKIGKEIT IM VERHÄLTNIß ZU DEN ENTSPRECHENDEN HERSTELLMAßEN IN PROZENTEN / DESVIACION MÁXIMA DE LA ORTOGONALIDAD, EN TANTO POR CIENTO, EN RELACION CON EL TAMAÑO DE FABRICATION CORRESPONDIENTE.	Squadrato ISO 13006	±0,3%	±1,5mm	±0,20%		ISO 10545-2	
	PLANARITÀ (CURVATURA DEL CENTRO, DELLO SPIGOLO E SVERGOLAMENTO) / FLATNESS (CURVING IN THE MIDDLE, CORNER AND WARPING) / PLANEITÉ (COURBURE CENTRALE, DE L'ARÊTE ET GAUCHISSEMENT) / EBENFLÄCHIGKEIT (KRÜMMUNG DER MITTE, DER KÄNTE UND VERWINDUNG) / PLANITUD (CURVATURA DEL CENTRO, DE LA ARISTA Y ABRUQUILLAMIENTO).	Squadrato ISO 13006	±0,4%	±1,8mm	±0,20%		ISO 10545-2	
	QUALITÀ DELLA SUPERFICIE / SURFACE QUALITY / QUALITÉ DE LA SURFACE / QUALITÄT DER OBERFLÄCHE / CALIDAD DE LA SUPERFICIE.	Il 95% min delle piastrelle deve essere esente da difetti visibili. At least 95% of the tiles must be free from visible flaws. 95% min des carreaux ne doivent présenter aucun défaut visible. Mindestens 95% der Fliesen müssen frei von sichtbaren min. El 95% de las baldosas tiene que estar exento de defectos visibles			CONFORME CONFORMING CONFORME KONFORM CONFORME		ISO 10545-2	
	MASSA D'ACQUA ASSORBITA IN % / % WATER ABSORPTION - MASSE D'EAU ABSORBÉE EN % / WASSERAUFNAHME IN % / MASA DE AGUA ABSORBIDA EN %		< 0,5%		valore medio 0,08%		ISO 10545-3	
	FORZA DI ROTTURA IN N (sp. < 7,5 mm) - BREAKING STRENGTH IN N (thickness < 7,5 mm) / FORCE DE RUPTURE EN N (ép. < 7,5 mm) / BRUCHLAST IN N (Dicke < 7,5 mm) / FUERZA DE ROTURA EN N (gr. < 7,5 mm)		≥ 700		valore medio 1350 Newton		ISO 10545-4	
	RESISTENZA ALLA FLESSIONE IN N/mm ² / N/mm ² FLEXURAL STRENGTH TEST / RÉSISTANCE A LA FLEXION EN N/mm ² / BIEGESTÄRKE IN N/mm		35 MIN.		valore medio 52 N/mm ²		ISO 10545-4	
	RESISTENZA ALL'ABRASIONE PROFONDA DELLE PIASTRELLE NON SMALTATE / RESISTANCE TO DEEP ABRASION OF UNGLAZED TILES / RESISTANCE A LABRASION PROFONDE DES CARREAUX NON ÉMAILLÉS / TIEFENABRIEFESTIGKEIT UNGLASIRTER FLIENEN / RESISTENCIA A LA ABRASIÓN PROFUNDA DE LAS BALDOSAS SIN ESMALTAR.		< 175 mm ³		valore medio 140 mm ³		ISO 10545-6	
	RESISTENZA AGLI SBALZI TERMICI / THERMAL SHOCKS RESISTANT / RÉSISTANCE AUX VARIATIONS THERMIQUES / TEMPERATURWECHSELBESTÄNDIGKEIT / RESISTENCIA AL CHOQUE TERMICO.	Metodo di prova disponibile / Available testing method Méthode d'essai disponible / Verfügbare Prüfmethode Método de ensayo disponible			RESISTE - RÉSISTANT RESISTE - ERFÜLLT RESISTE		ISO 10545-9	
	RESISTENZA AL GELO / FROST RESISTANCE / RÉSISTANCE AU GEL / FROSTSICHERHEIT / RESISTENCIA A LA HELADA	RICHIESTA - REQUIRED REQUISE - GEFORDERT REQUERIDA			RESISTE - RÉSISTANT RESISTE - ERFÜLLT RESISTE		ISO 10545-12	
	RESISTENZA ALLE MACCHIE / RESISTANCE TO STAINING / RÉSISTANCE AUX TACHES / FLECKENABWEISEND / RESISTENCIA A LAS MANCHAS.	Metodo di prova disponibile / Available testing method Méthode d'essai disponible / Verfügbare Prüfmethode Método de ensayo disponible			Classe 5	Classe 4	Classe 4	ISO 10545-14
	RILASCIO DI SOSTANZE PERICOLOSE / RELEASE OF HAZARDOUS SUBSTANCES / REJET DE SUBSTANCES DANGEREUSES / FREISETZUNG GEFAHRLICHER STOFFE / LIBERACION DE SUSTANCIAS PELIGROSAS / CADMIO (in mg/dm ²) - PIOMBO (in mg/dm ²)	VALORE DICHIARATO PER SUPERFICIE GL. CON IMPREGH SU PIANI DI LAVORO / DECLARED VALUE FOR GL SURFACES USED ON WORKTOPS / VALUEUR DÉCLARÉ POUR SURFACES GL UTILISÉES SUR PLANS DE TRAVAIL / ANGEBOBENER WERT FÜR GL OBERFLÄCHEN ZUM GEBRAUCH ALS ARBEITSPLATZEN / VALOR DECLARADO PARA ACABADOS GL UTILIZADOS PARA SUPERFICIES DE TRABAJO			CONFORME/CONFORMING CONFORME/KONFORM CONFORME		DM 1/2/2007 Reg. CE 1935/2004	
	RESISTENZA A BASSE CONCENTRAZIONI DI ACIDI E ALCALI. / RESISTANCE TO LOW CONCENTRATIONS OF ACIDS AND ALKALIS. / RESISTANCE A BASSES CONCENTRATIONS D'ACIDES ET ALCALIS. / WIDERSTAND GEGEN NIEDRIGE KONZENTRATIONEN VON SAUREN UND LAUGEN. / RESISTENCIA A BAJAS CONCENTRACIONES DE ACIDOS Y ALCALIS.	COME DICHIARATO DAL PRODUTTORE SEE MANUFACTURER'S DECLARATION SELON DÉCLARATION DU PRODUCTEUR ENTSPRECHEND DER HERSTELLERANGABEN TAL COMO DECLARA EL FABRICANTE.			ULA		ISO 10545-13	
	RESISTENZA AI PRODOTTI CHIMICI DI USO DOMESTICO E AGLI ADDITIVI PER PISCINA / RESISTENCE TO DOMESTIC CHEMICAL PRODUCTS AND ADDITIVES FOR SWIMMING POOLS / RESISTANT AUX PRODUITS CHIMIQUES A USAGE DOMESTIQUE ET AUX ADDITIFS POUR PISCINE / WIDERSTAND GEGEN HAUSHALTS-CHEMIKALIEN UND / SCHWIMMBADZUSATZSTOFFEN / RESISTENCIA A PRODUCTOS PARA LIMPIEZA DOMESTICA Y ADITIVOS PARA PISCINAS	MIN B			UA			
					> 0,42 wet		DCOF ANSI A 326.3	
	COEFFICIENTE D'ATTRITO (SCIVOLOSITÀ) / FRICTION COEFFICIENT (SLIPPERINESS) / COEFFICIENT DE FRICTION (GLISSEMENT) / REIBUNGSKOEFFIZIENT (SCHLUPFRIGKEIT) / COEFFICIENTE DE ANTI DESLIZAMIENTO.				6° ≤ α < 10° R9	10° ≤ α < 19° R10	10° ≤ α < 19° R10	DIN EN 16165 ANNEX B
					-	18° ≤ α < 24° classe B	18° ≤ α < 24° classe B	DIN EN 16165 ANNEX A
							>36 wet	BS EN 16165 ANNEX C

Per un effetto ottimale della posa, florim suggerisce di mantenere 2 mm di fuga per pose monoformato e 3 mm per combinare formati misti / For optimal installation results, florim recommends maintaining a joint of 2 mm 1/12" for single format installations and 3 mm 1/8" to combine mixed formats / Pour réaliser une pose parfaite, florim suggère de maintenir 2 mm de joint pour la pose des monoformats, et 3 mm pour les combinaisons de formats mixtes / Um einen optimalen effekt beim verlegen zu erzielen empfehlt florim eine 2 mm fuge bei einformatigen verlegungen und 3 mm fuge bei formatkombinationen / Para lograr los máximos resultados en la posa del producto, florim aconseja 2 mm de junta en aplicaciones monoformato y 3 mm en combinaciones de formatos mixtos.











CARATTERISTICHE TECNICHE - TECHNICAL CHARACTERISTICS - CARACTERISTIQUES TECHNIQUES - TECHNISCHE EIGENSCHAFTEN - CARACTERÍSTICAS TÉCNICAS								
	Lastre in gres fine porcellanato non smaltato. Piastrelle di ceramica pressate a secco. Caratteristiche di qualità secondo i test di controllo previsti dalla norma EN 14411-ISO 13006 Appendice G gruppo Bla UGL. / Unglazed porcelain stoneware slabs. Dry-pressed ceramic tiles. Quality specifications, according to control tests of EN 14411-ISO 13006 Appendix G group Bla UGL. / Dalles en grès cérame fin non émaillé. Carreaux céramiques pressés à sec. Caractéristiques de qualité d'après les essais de contrôle norme EN 14411-ISO 13006 Appendice G groupe Bla UGL. / Nicht glasierte und vollständig gesinterte Feinsteinzeugplatten. Trocken gepresste Keramikfliesen. Qualitätseigenschaften nach Normen EN 14411-ISO 13006 Anhang G Gruppe Bla UGL. / Planchas de gres porcelánico fino no esmaltado. Baldosas de cerámica ensadas en seco. Características de calidad según las Normas EN 14411-ISO 13006 Apéndice G grupo Bla UGL.	PRESCRIZIONE STANDARD REQUIREMENTS PRESCRIPTIONS ANFORDERUNGEN PRESCRIPCION		RISULTATI TESTS TEST RESULTS RESULTATS DES ESSAIS PRÜFERGEBNIS RESULTADOS TESTS			RIFERIMENTO NORMA REFERENCE STANDARD RÉFERENCE NORME STANDARDWERT REFERENCIA NORMA	
		N ≥ 15 cm		N ≥ 15 cm				
		(%)	(mm)	smooth	comfort	glossy		
	LUNGHEZZA E LARGHEZZA: DEVAZIONE AMMISSIBILE, IN % DELLA DIMENSIONE MEDIA DI OGNI PIASTRELLA DALLA DIM. DI FABBRICAZIONE / LENGTH AND WIDTH: ADMITTED DEVIATION, IN % OF THE AVERAGE SIZE OF EACH TILE FROM THE PRODUCTION DIMENSIONS / LONGUEUR ET LARGEUR : MARGE DE TOLÉRANCE, EN %, ENTRE LA DIMENSION MOYENNE DE CHAQUE CARREAU ET LA DIM. DE FABRICATION / LANGE UND BREITE: ZULÄSSIGE ABWEICHUNG DES DURCHSCHNITTMÄßES JEDER FLIESE VOM HERSTELLMAß IN PROZENTEN / LARGO Y ANCHO: DESVIACION ADMISIBLE, EN %, DEL TAMAÑO MEDIO DE CADA BALDOSA A PARTIR DEL TAMAÑO DE FABRICACION.	Squadrato ISO 13006	±0,3%	±1,0mm	±0,15%			ISO 10545-2
	DEVAZIONE AMMISSIBILE, IN PERCENTO, DELLO SPESORE MEDIO DI OGNI PIASTRELLA DALLA DIMENSIONE DI FABBRICAZIONE / ADMITTED DEVIATION, IN % OF THE AVERAGE THICKNESS OF EACH TILE FROM THE PRODUCTION DIMENSIONS / MARGE DE TOLÉRANCE, EN POURCENTAGE, ENTRE L'ÉPAISSEUR MOYENNE DE CHAQUE CARREAU ET LA DIMENSION DE FABRICATION / ZULÄSSIGE ABWEICHUNG DER DURCHSCHNITTSDICKE JEDER FLIESE VOM HERSTELLMAß IN PROZENTEN / DESVIACION ADMISIBLE, EN TANTO POR CIENTO, DEL GROSOR MEDIO DE CADA BALDOSA A PARTIR DEL TAMAÑO DE FABRICACION.	-	±5%	±0,5mm	±5%			ISO 10545-2
	DEVAZIONE MASSIMA DI RETTILINEARITÀ, IN PERCENTO, IN RAPPORTO ALLE DIMENSIONI DI FABBRICAZIONE CORRISPONDENTI / MAXIMUM STRAIGHTNESS DEVIATION, IN % IN RELATION TO THE CORRESPONDING PRODUCTION DIMENSIONS / MARGE DE TOLÉRANCE D'ANGLES EN POURCENTAGE, PAR RAPPORT AUX DIMENSIONS DE FABRICATION CORRESPONDANTES / ZULÄSSIGE HOCHSTABWEICHUNG DER KANTENGERADHEIT IM VERHÄLTNIS ZU DEN ENTSPRECHENDEN HERSTELLMAßEN IN PROZENTEN / DESVIACION MÁXIMA DE RECTITUD, EN TANTO POR CIENTO, EN RELACION CON EL TAMAÑO DE FABRICACION CORRESPONDIENTE.	Squadrato ISO 13006	±0,3%	±0,8mm	±0,10%			ISO 10545-2
	DEVAZIONE MASSIMA DI ORTOGONALITÀ, IN PERCENTO, IN RAPPORTO ALLE DIMENSIONI DI FABBRICAZIONE CORRISPONDENTI / MAXIMUM RIGHT-ANGLE DEVIATION, IN % IN RELATION TO THE CORRESPONDING PRODUCTION DIMENSIONS / MARGE DE TOLÉRANCE D'ANGLES EN POURCENTAGE, PAR RAPPORT AUX DIMENSIONS DE FABRICATION / HOCHSTABWEICHUNG DER RECHTWINKLIGKEIT IM VERHÄLTNIS ZU DEN ENTSPRECHENDEN HERSTELLMAßEN IN PROZENTEN / DESVIACION MÁXIMA DE LA ORTOGONALIDAD, EN TANTO POR CIENTO, EN RELACION CON EL TAMAÑO DE FABRICACION CORRESPONDIENTE.	Squadrato ISO 13006	±0,3%	±1,5mm	±0,20%			ISO 10545-2
	PLANARITÀ (CURVATURA DEL CENTRO, DELLO SPIGOLO E SVERGOLAMENTO) / FLATNESS (CURVING IN THE MIDDLE, CORNER AND WARPING) / PLANÉITÉ (COURBURE CENTRALE, DE L'ARÊTE ET GAUCHISSEMENT) / EBENFLÄCHIGKEIT (KRÜMMUNG DER MITTE, DER KANTE UND VERWINDUNG) / PLANITUD (CURVATURA DEL CENTRO, DE LA ARISTA Y ABARQUILLAMIENTO).	Squadrato ISO 13006	±0,4%	±1,8mm	±0,20%			ISO 10545-2
	QUALITÀ DELLA SUPERFICIE / SURFACE QUALITY / QUALITÉ DE LA SURFACE / QUALITÄT DER OBERFLÄCHE / CALIDAD DE LA SUPERFICIE.	Il 95% min delle piastrelle deve essere esente da difetti visibili. / At least 95% of the tiles must be free from visible flaws. 95% min des carreaux ne doivent présenter aucun défaut visible. Mindestens 95% der Fliesen müssen frei von sichtbaren min. / el 95% de las baldosas tiene que estar exento de defectos visibles.			CONFORME/CONFORMING CONFORME/KONFORM CONFORME			ISO 10545-2
	MASSA D'ACQUA ASSORBITA IN % / % WATER ABSORPTION - MASSE D'EAU ABSORBÉE EN % / WASSERAUFNAHME IN % / MASA DE AGUA ABSORBIDA EN %		< 0,5%		valore medio 0,08%			ISO 10545-3
	FORZA DI ROTTURA IN N (sp. < 7,5 mm) - BREAKING STRENGTH IN N (thickness < 7,5 mm) / FORCE DE RUPTURE EN N (ép. < 7,5 mm) / BRUCHLAST IN N (Dicke < 7,5 mm) / FUERZA DE ROTURA EN N (gr. < 7,5 mm).		≥ 700		valore medio 1350 Newton			ISO 10545-4
	RESISTENZA ALLA FLESSIONE IN N/mm2 / N/mm2 FLEXURAL STRENGTH TEST / RESISTENCIA A LA FLEXION EN N/mm2 / BIEGEFESTIGKEIT IN N/mm2 / RESISTENCIA A LA FLEXION EN N/mm		35 MIN.		valore medio 52 N/mm2			ISO 10545-4
	RESISTENZA ALL'ABRASIONE PROFONDA DELLE PIASTRELLE NON SMALTATE / RESISTANCE TO DEEP ABRASION OF UNGLAZED TILES / RESISTANCE À L'ABRASION PROFONDE DES CARREAUX NON ÉMAILLÉS / TIEFENABRIEFESTIGKEIT UNGLASIRTER FLIESEN / RESISTENCIA A LA ABRASIÓN PROFUNDA DE LAS BALDOSAS SIN ESMALTAR.		< 175 mm ³		valore medio 140 mm ³			ISO 10545-6
	RESISTENZA AGLI SBALZI TERMICI / THERMAL SHOCKS RESISTANT / RESISTANCE AUX VARIATIONS THERMIQUES / TEMPERATURWECHSELBESTÄNDIGKEIT / RESISTENCIA AL CHOQUE TÉRMICO.		Metodo di prova disponibile / Available testing method Méthode d'essai disponible / Verfügbare Prüfmethode Método de ensayo disponible		RESISTE - RESISTANT RESISTE - ERFÜLLT RESISTE			ISO 10545-9
	RESISTENZA AL GELO / FROST RESISTANCE / RESISTANCE AU GEL / FROSTSICHERHEIT / RESISTENCIA A LA HELADA		RICHIESTA - REQUIRED REQUISE - GEFORDERT REQUERIDA		RESISTE - RESISTANT RESISTE - ERFÜLLT RESISTE			ISO 10545-12
	RESISTENZA ALLE MACCHIE / RESISTANCE TO STAINING / RESISTANCE AUX TACHES / FLECKENABWEISEND / RESISTENCIA A LAS MANCHAS.				Classe 3	Classe 4	Classe 3	ISO 10545-14
	RILASCIO DI SOSTANZE PERICOLOSE / RELEASE OF HAZARDOUS SUBSTANCES / REJET DE SUBSTANCES DANGEREUSES / FREISETZUNG GEFAHRLICHER STOFFE / LIBERACION DE SUSTANCIAS PELIGROSAS / CADMIO (in mg/dm ²) - PIOMBO (in mg/dm ²)		VALORE DICHIARATO PER SUPERFICIE CON IMPIEGHI SU PAVI DI LAVORO / DECLARED VALUE FOR GL SURFACES USED ON WORKTOPS / VALEUR DÉCLARÉE POUR SURFACES GL UTILISÉES SUR PLANS DE TRAVAIL / ANGELEGEBENER WERT FÜR GL OBERFLÄCHEN ZUM GEBRAUCH ALS ARBEITSPLÄTTEN / VALOR DECLARADO PARA ACABADOS GL UTILIZADOS PARA SUPERFICIES DE TRABAJO		CONFORME/CONFORMING CONFORME/KONFORM CONFORME			DM-1-2-2007-Reg-CE-1935-2004
	RESISTENZA A BASSE CONCENTRAZIONI DI ACIDI E ALCALI. / RESISTANCE TO LOW CONCENTRATIONS OF ACIDS AND ALKALIS. / RESISTANCE À BASSES CONCENTRATIONS D'ACIDES ET ALCALIS. / WIDERSTAND GEGEN NIEDRIGE KONZENTRATIONEN VON SAUREN UND LAUGEN. / RESISTENCIA A BAJAS CONCENTRACIONES DE ACIDOS Y ALCALIS.		COME DICHIARATO DAL PRODUTTORE SEE MANUFACTURERS DECLARATION SELON DÉCLARATION DU PRODUCTEUR ENTSPRECHEND DER HERSTELLERANGABEN TAL COMO DECLARA EL FABRICANTE		ULA	ULA-ULB	ULB	ISO 10545-13
	RESISTENZA AI PRODOTTI CHIMICI DI USO DOMESTICO E AGLI ADDITIVI PER PISCINA / RESISTANCE TO DOMESTIC CHEMICAL PRODUCTS AND ADDITIVES FOR SWIMMING POOLS / RESISTANT AUX PRODUITS CHIMIQUES À USAGE DOMESTIQUE ET AUX ADDITIFS POUR PISCINE / WIDERSTAND GEGEN HAUSHALTSCHIMIKALIEN UND / SCHWIMMBADZUSATZSTOFFEN / RESISTENCIA A PRODUCTOS PARA LIMPIEZA DOMESTICA Y ADITIVOS PARA PISCINAS		MIN B		UA			
	COEFFICIENTE D'ATTRITO (SCIVOLOSITÀ) / FRICTION COEFFICIENT (SLIPPERINESS) / COEFFICIENT DE FRICTION (GLISSEMENT) / REIBUNGSKOEFFIZIENT (SCHLUPFRIGKEIT) / COEFFICIENTE DE ANTI DESLIZAMIENTO.		-		> 0,42 wet	> 0,42 wet	-	DCOF ANSI A 326.3
			-		-	10° ≤ α < 19° R10	-	DIN EN 16165 ANNEX B
			-		-	18° ≤ α < 24° classe B	-	DIN EN 16165 ANNEX A
			-		-	PTV>36 wet slider 45	-	BS EN 16165 ANNEX C

Per un effetto ottimale della posa, florim suggerisce di mantenere 2 mm di fuga per pose monofornate e 3 mm per combinare formati misti / For optimal installation results, florim recommends maintaining a joint of 2 mm 1/12" for single format installations and 3 mm 1/8" to combine mixed formats / Pour réaliser une pose parfaite, florim suggère de maintenir 2 mm de joint pour la pose des monofornats, et 3 mm pour les combinaisons de formats mixtes / Um einen optimalen effekt beim verlegen zu erzielen empfehlt florim eine 2 mm fuger bei einformatigen verlegungen und 3 mm fuger bei formatkombinationen / Para lograr los maximos resultados en la posa del producto, florim aconsejó 2 mm de junta en aplicaciones monofornato y 3 mm en combinaciones de formatos mixtos.

URBAN STYLE

GRES FINE PORCELLANATO/FINE PORCELAIN STONWARE/GRES CERAME FIN/FEINSTEINZEUG-KOLLEKTIONEN/GRES PORCELANICO FINO
SQUADRATO - SQUARED - EQUARRI - REKTIFIZIERT - ESCUADRADO

6 mm 1/4" 













CARATTERISTICHE TECNICHE - TECHNICAL CHARACTERISTICS - CARACTERISTIQUES TECHNIQUES - TECHNISCHE EIGENSCHAFTEN - CARACTERÍSTICAS TÉCNICAS							
	PRESCRIZIONE STANDARD REQUIREMENTS PRESCRIPTIONS ANFORDERUNGEN PRESCRIPCION	N ≥ 15 cm (%) (mm)	RISULTATI TESTS TEST RESULTS RESULTATS DES ESSAIS PRÜFERGEBNIS RESULTADOS TESTS	RIFERIMENTO NORMA REFERENCE STANDARD RÉFÉRENCE NORME STANDARWERT REFERENCIA NORMA			
			<p>Lastre in gres fine porcellanato non smaltato. Piastrelle di ceramica pressate a secco. Caratteristiche di qualità secondo i test di controllo previsti dalla norma EN 14411-ISO 13006 Appendice G gruppo Bia UGL. / Unglazed porcelain stoneware slabs. Dry-pressed ceramic tiles. Quality specifications, according to control tests of EN 14411-ISO 13006 Appendix G group Bia UGL. / Dalles en grés céramique fin non émaillé. Carreaux céramiques pressés à sec. Caractéristiques de qualité d'après les essais de contrôle norme EN 14411-ISO 13006 Appendice G groupe B1a UGL. / Nicht glasierte und vollständig gesinterter Feinsteinzeugplatten. Trocken gepresste Keramikfliesen. Qualitätseigenschaften nach Normen EN 14411-ISO 13006 Anhang G Gruppe Bia UGL. / Planchas de gres porcelánico fino no esmaltado. Baldosas de cerámica resandás en seco. Características de calidad según las Normas EN 14411-ISO 13006 Apéndice G grupo Bia UGL.</p>				
	LUNGHEZZA E LARGHEZZA: DEVIAZIONE AMMISSIBILE, IN %, DELLA DIMENSIONE MEDIA DI OGNI PIASTRELLA DALLA DIM. DI FABBRICAZIONE / LENGTH AND WIDTH: ADMITTED DEVIATION, IN %, OF THE AVERAGE SIZE OF EACH TILE FROM THE PRODUCTION DIMENSIONS / LONGUEUR ET LARGEUR : MARGE DE TOLÉRANCE, EN %, ENTRE LA DIMENSION MOYENNE DE CHAQUE CARREAU ET LA DIM. DE FABRICATION / LANGE UND BREITE: ZULASSIGE ABWEICHUNG DES DURCHSCHNITTMÄßES JEDER FLIESE VOM HERSTELLMAß IN PROZENTEN / LARGO Y ANCHO: DESVIACION ADMISIBLE, EN %, DEL TAMAÑO MEDIO DE CADA BALDOSA A PARTIR DEL TAMAÑO DE FABRICACIÓN.	Squadrato ISO 13006	±0,3%	±1,0mm	±0,15%	ISO 10545-2	
	DEVIAZIONE AMMISSIBILE IN PERCENTO DELLO SPESORE MEDIO DI OGNI PIASTRELLA DALLA DIMENSIONE DI FABBRICAZIONE / ADMITTED DEVIATION, IN %, OF THE AVERAGE THICKNESS OF EACH TILE FROM THE PRODUCTION DIMENSIONS / MARGE DE TOLÉRANCE, EN POURCENTAGE, ENTRE L'ÉPAISSEUR MOYENNE DE CHAQUE CARREAU ET LA DIMENSION DE FABRICATION / ZULASSIGE ABWEICHUNG DER DURCHSCHNITTSDICKE JEDER FLIESE VON HERSTELLMAß IN PROZENTEN / DESVIACION ADMISIBLE, EN TANTO POR CIENTO, DEL GROSOR MEDIO DE CADA BALDOSA A PARTIR DEL TAMAÑO DE FABRICACIÓN.	-	±5%	±0,5mm	±5%	ISO 10545-2	
	DEVIAZIONE MASSIMA DI RETTILINEARITÀ, IN PERCENTO, IN RAPPORTO ALLE DIMENSIONI DI FABBRICAZIONE CORRISPONDENTI / MAXIMUM STRAIGHTNESS DEVIATION, IN %, IN RELATION TO THE CORRESPONDING PRODUCTION DIMENSIONS / MARGE DE TOLÉRANCE DE RECTITUDE, EN POURCENTAGE, PAR RAPPORT AUX DIMENSIONS DE FABRICATION / HOCHSTABWEICHUNG DER RECHTWINKLIGKEIT IM VERHÄLTNIß ZU DEN ENTSPRECHENDEN HERSTELLMAßEN IN PROZENTEN / DESVIACION MÁXIMA DE RECTITUD, EN TANTO POR CIENTO, EN RELACION CON EL TAMAÑO DE FABRICACIÓN CORRESPONDIENTE.	Squadrato ISO 13006	±0,3%	±0,8mm	±0,10%	ISO 10545-2	
	DEVIAZIONE MASSIMA DI ORTOGONALITÀ, IN PERCENTO, IN RAPPORTO ALLE DIMENSIONI DI FABBRICAZIONE CORRISPONDENTI MAXIMUM RIGHT-ANGLE DEVIATION, IN %, IN RELATION TO THE CORRESPONDING PRODUCTION DIMENSIONS / MARGE DE TOLÉRANCE D'ANGULARITÉ, EN POURCENTAGE, PAR RAPPORT AUX DIMESIONS DE FABRICATION / HOCHSTABWEICHUNG DER RECHTWINKLIGKEIT IM VERHÄLTNIß ZU DEN ENTSPRECHENDEN HERSTELLMAßEN IN PROZENTEN / DESVIACION MÁXIMA DE LA ORTOGONALIDAD, EN TANTO POR CIENTO, EN RELACION CON EL TAMAÑO DE FABRICACIÓN CORRESPONDIENTE.	Squadrato ISO 13006	±0,3%	±1,5mm	±0,2%	ISO 10545-2	
	PLANARITÀ (CURVATURA DEL CENTRO, DELLO SPIGOLO E SVERGOLAMENTO) / FLATNESS (CURVING IN THE MIDDLE, CORNER AND WARPING) / PLANÉITÉ (COURBURE CENTRALE, DE L'ARÊTE ET GAUCHISSEMENT) / EBENFLÄCHIGKEIT (KRÜMMUNG DER MITTE, DER KANTE UND VERWINDUNG) / PLANITUD (CURVATURA DEL CENTRO, DE LA ARISTA Y ABRUQUILLAMIENTO).	Squadrato ISO 13006	±0,4%	±1,8mm	±0,2%	ISO 10545-2	
	QUALITÀ DELLA SUPERFICIE / SURFACE QUALITY / QUALITÉ DE LA SURFACE / QUALITÄT DER OBERFLÄCHE / CALIDAD DE LA SUPERFICIE.				Il 95% min delle piastrelle deve essere esente da difetti visibili. / At least 95% of the tiles must be free from visible flaws. 95% min des carreaux ne doivent présenter aucun défaut visible. Mindestens 95% der Fliesen müssen frei von sichtbaren min. / el 95% de las baldosas tiene que estar exento de defectos visibles.	CONFORME/CONFORMING CONFORME/KONFORM CONFORME	ISO 10545-2
	MASSA D'ACQUA ASSORBITA IN % / % WATER ABSORPTION - MASSE D'EAU ABSORBÉE EN % / WASSERAUFNAHME IN % / MASA DE AGUA ABSORBIDA EN %		< 0,5%		valore medio 0,08%	ISO 10545-3	
	FORZA DI ROTTURA IN N (sp. < 7,5 mm) - BREAKING STRENGTH IN N (thickness < 7,5 mm) / FORCE DE RUPTURE EN N (ép. < 7,5 mm) / BRUCHLAST IN N (Dicke < 7,5 mm) / FUERZA DE ROTURA EN N (gr. < 7,5 mm).		≥ 700		valore medio 1350 Newton	ISO 10545-4	
	RESISTENZA ALLA FLESSIONE IN N/mm2 / N/mm2 FLEXURAL STRENGTH TEST / RÉSISTANCE A LA FLEXION EN N/mm2 / BIEGESTÄRKE IN N/mm / RESISTENCIA A LA FLEXIÓN EN N/mm		35 MIN.		valore medio 52 N/mm2	ISO 10545-4	
	RESISTENZA ALL'ABRASIONE PROFONDA DELLE PIASTRELLE NON SMALTATE / RESISTANCE TO DEEP ABRASION OF UNGLAZED TILES / RÉSISTANCE À L'ABRASION PROFONDE DES CARREAUX NON ÉMAILLÉS / TIEFENABRIEBEFESTIGKEIT UNGLASIRTER FLIESEN / RESISTENCIA A LA ABRASION PROFUNDA DE LAS BALDOSAS SIN ESMALTAR.		< 175 mm ³		valore medio 140 mm ³	ISO 10545-6	
	RESISTENZA AGLI SBALZI TERMICI / THERMAL SHOCKS RESISTANT / RÉSISTANCE AUX VARIATIONS THERMIQUES / TEMPERATURWECHSELBESTÄNDIGKEIT / RESISTENCIA AL CHOQUE TÉRMICO.		Metodo di prova disponibile / Available testing method Méthode d'essai disponible / Verfügbare Prüfmethode Método de ensayo disponible		RESISTE - RÉSISTANT RÉSISTE - ERFÜLLT RESISTE	ISO 10545-9	
	RESISTENZA AL GELO / FROST RESISTANCE / RÉSISTANCE AU GEL / FROSTSICHERHEIT RESISTENCIA A LA HELADA		RICHIESTA - REQUIRED REQUIRE - GEFORDERT REQUERIDA		RESISTE - RÉSISTANT RÉSISTE - ERFÜLLT RESISTE	ISO 10545-12	
	RESISTENZA ALLE MACCHIE / RESISTANCE TO STAINING / RÉSISTANCE AUX TACHES / FLECKENABWEISEND / RESISTENCIA A LAS MANCHAS.		Metodo di prova disponibile / Available testing method Méthode d'essai disponible / Verfügbare Prüfmethode Método de ensayo disponible		Classe 4	ISO 10545-14	
	RILASCIO DI SOSTANZE PERICOLOSE / RELEASE OF HAZARDOUS SUBSTANCES / REJET DE SUBSTANCES DANGEREUSES / FREISETZUNG GEFAHRLICHER STOFFE / LIBERACION DE SUSTANCIAS PELIGROSAS / CADMIO (in mg/dm ²) - PIOMBO (in mg/dm ²)		VALORE DICHIARATO PER SUPERFICIE GL. CON IMPIEGHI SU PIANI DI LAVORO / DECLARED VALUE FOR GL SURFACES USED ON WORKTOPS / VALEUR DÉCLARÉE POUR SURFACES GL UTILISÉES SUR PLANS DE TRAVAIL ANGEBOGENEN WERT FÜR GL OBERFLÄCHEN ZUM GEBRAUCH ALS ARBEITSPLÄTZE / VALOR DECLARADO PARA ACABADOS GL UTILIZADOS PARA SUPERFICIES DE TRABAJO		CONFORME/CONFORMING CONFORME/KONFORM CONFORME	DM-1-2-2007-Reg-CE-1935-2004	
	RESISTENZA A BASSE CONCENTRAZIONI DI ACIDI E ALCALI. / RESISTANCE TO LOW CONCENTRATIONS OF ACIDS AND ALKALIS. / RESISTANCE A BASSES CONCENTRATIONS D'ACIDES ET ALCALIS. / WIDERSTAND GEGEN NIEDRIGE KONZENTRATIONEN VON SAUREN UND LAUGEN. / RESISTENCIA A BAJAS CONCENTRACIONES DE ACIDOS Y ALCALIS.		COME DICHIARATO DAL PRODUTTORE SEE MANUFACTURER'S DECLARATION SELON DÉCLARATION DU PRODUCTEUR ENTSPRECHEND DER HERSTELLERANGABEN TAL COMO DECLARA EL FABRICANTE		ULA	ISO 10545-13	
	RESISTENZA AI PRODOTTI CHIMICI DI USO DOMESTICO E AGLI ADDITIVI PER PISCINA / RESISTANCE TO DOMESTIC CHEMICAL PRODUCTS AND ADDITIVES FOR SWIMMING POOLS / RÉSISTANT AUX PRODUITS CHIMIQUES À USAGE DOMESTIQUE ET AUX ADDITIFS POUR PISCINE / WIDERSTAND GEGEN HAUSHALTSCHIMIKALIEN UND / SCHWIMMBADZUSATZSTOFFEN / RESISTENCIA A PRODUCTOS PARA LIMPIEZA DOMESTICA Y ADITIVOS PARA PISCINAS		MIN B		UA		
	COEFFICIENTE D'ATTRITO (SCIVOLOSITÀ) / FRICTION COEFFICIENT (SLIPPERINESS) / COEFFICIENT DE FRICTION (GLISSEMENT) / REIBUNGSKOEFFIZIENT (SCHLUPFRIGKEIT) / COEFICIENTE DE ANTI DESLIZAMIENTO.		-		6° ≤ α < 10° R9	DIN EN 16165 ANNEX B	
					> 0,42 wet	DCOF ANSI A 326.3	

Per un effetto ottimale della posa, florim suggerisce di mantenere 2 mm di fuga per pose monofornate e 3 mm per combinare formati misti / For optimal installation results, florim recommends maintaining a joint of 2 mm 1/16" for single format installations and 3 mm 1/8" to combine mixed formats / Pour réaliser une pose parfaite, florim suggère de maintenir 2 mm de joint pour la pose des monofornats, et 3 mm pour les combinaisons de formats mixtes / Um einen optimalen effekte beim verlegen zu erzielen empfiehlt florim eine 2 mm fuge bei einformatigen verlegungen und 3 mm fuge bei formatkombinationen / Para lograr los máximos resultados en la posa del producto, florim aconseja 2 mm de junta en aplicaciones monofornato y 3 mm en combinaciones de formatos mixtos.

NEUTRA 6.0 - TINTE UNITE

GRES FINE PORCELLANATO/FINE PORCELAIN STONEWARE/GRES CERAME FIN/FEINSTEINZEUG-KOLLEKTIONEN/GRES PORCELANICO FINO
SQUADRATO - SQUARED - EQUARRI - REKTIFIZIERT - ESCUADRADO

6 mm 1/4" 

CARATTERISTICHE TECNICHE - TECHNICAL CHARACTERISTICS - CARACTERISTIQUES TECHNIQUES - TECHNISCHE EIGENSCHAFTEN - CARACTERÍSTICAS TÉCNICAS						
	Lastre in gres fine porcellanato non smaltato. Piastrelle di ceramica pressate a secco. Caratteristiche di qualità secondo i test di controllo previsti dalla norma EN 14411-ISO 13006 Appendice G gruppo Bia UGL. / Unglazed porcelain stoneware slabs. Dry-pressed ceramic tiles. Quality specifications, according to control tests of EN 14411-ISO 13006 Appendix G group Bia UGL. / Dalles en gres cérame fin non émaillé. Carreaux céramiques pressés à sec. Caractéristiques de qualité d'après les essais de contrôle norme EN 14411-ISO 13006 Appendice G groupe Bia UGL. / Nicht glasierte und vollständig gesinterter Feinsteinzeugplatten. Trocken gepresste Keramikfliesen. Qualitätseigenschaften nach Normen EN 14411-ISO 13006 Anhang G Gruppe Bia UGL. / Platiņas gres porcelāniskās ar zemas glazūras pārklājumu. Īpašības prasības saskaņā ar EN 14411-ISO 13006 pielikuma G grupas Bia UGL. / Baldosas de gres porcelánico fino no esmaltado. Baldosas de cerámica resnadas en seco. Características de calidad según las Normas EN 14411-ISO 13006 Apéndice G grupo Bia UGL.	PRESCRIZIONE STANDARD REQUIREMENTS PRESCRIPTIONS ANFORDERUNGEN PRESCRIPTION		RISULTATI TESTS TEST RESULTS RESULTATS DES ESSAIS PRÜFERGEBNIS RESULTADOS TESTS	RIFERIMENTO NORMA REFERENCE STANDARD STANDARDWERT REFERENCIA NORMA	
		N ≥ 15 cm				
		(%)	(mm)			
	LUNGHEZZA E LARGHEZZA: DEVIAZIONE AMMISSIBILE, IN %, DELLA DIMENSIONE MEDIA DI OGNI PIASTRELLA DALLA DIM. DI FABBRICAZIONE / LENGTH AND WIDTH: ADMITTED DEVIATION, IN %, OF THE AVERAGE SIZE OF EACH TILE FROM THE PRODUCTION DIMENSIONS / LONGUEUR ET LARGEUR : MARGE DE TOLÉRANCE, EN %, ENTRE LA DIMENSION MOYENNE DE CHAQUE CARREAU ET LA DIM. DE FABRICATION / LANGE UND BREITE: ZULÄSSIGE ABWEICHUNG DES DURCHSCHNITTMÄßES JEDER FLIESE VOM HERSTELLMAß IN PROZENTEN / LARGO Y ANCHO: DESVIACION ADMISIBLE, EN %, DEL TAMAÑO MEDIO DE CADA BALDOSA A PARTIR DEL TAMAÑO DE FABRICACIÓN.	Squadrato ISO 13006	±0,3%	±1,0mm	±0,15%	ISO 10545-2
	DEVIAZIONE AMMISSIBILE, IN PERCENTO, DELLO SPESSORE MEDIO DI OGNI PIASTRELLA DALLA DIMENSIONE DI FABBRICAZIONE / ADMITTED DEVIATION, IN %, OF THE AVERAGE THICKNESS OF EACH TILE FROM THE PRODUCTION DIMENSIONS / MARGE DE TOLÉRANCE, EN POURCENTAGE, ENTRE L'ÉPAISSEUR MOYENNE DE CHAQUE CARREAU ET LA DIMENSION DE FABRICATION / ZULÄSSIGE ABWEICHUNG DER DURCHSCHNITTSDICKE JEDER FLIESE VOM HERSTELLMAß IN PROZENTEN / DESVIACION ADMISIBLE, EN TANTO POR CIENTO, DEL GROSOR MEDIO DE CADA BALDOSA A PARTIR DEL TAMAÑO DE FABRICACIÓN.	-	±5%	±0,5mm	±5%	ISO 10545-2
	DEVIAZIONE MASSIMA DI RETTILINEARITÀ, IN PERCENTO, IN RAPPORTO ALLE DIMENSIONI DI FABBRICAZIONE CORRISPONDENTI / MAXIMUM STRAIGHTNESS DEVIATION, IN %, IN RELATION TO THE CORRESPONDING PRODUCTION DIMENSIONS / MARGE DE TOLÉRANCE DE RECTITUDE, EN POURCENTAGE, PAR RAPPORT AUX DIMENSIONS DE FABRICATION CORRÉPONDANTES / ZULÄSSIGE ABWEICHUNG DER KANTENGERADHEIT IM VERHÄLTNIS ZU DEN ENTSPRECHENDEN HERSTELLMÄßEN IN PROZENTEN / DESVIACIÓN MÁXIMA DE RECTITUD, EN TANTO POR CIENTO, EN RELACIÓN CON EL TAMAÑO DE FABRICACIÓN CORRESPONDIENTE.	Squadrato ISO 13006	±0,3%	±0,8mm	±0,10%	ISO 10545-2
	DEVIAZIONE MASSIMA DI ORTOGONALITÀ, IN PERCENTO, IN RAPPORTO ALLE DIMENSIONI DI FABBRICAZIONE CORRISPONDENTI MAXIMUM RIGHT-ANGLE DEVIATION, IN %, IN RELATION TO THE CORRESPONDING PRODUCTION DIMENSIONS / MARGE DE TOLÉRANCE D'ANGULARITÉ, EN POURCENTAGE, PAR RAPPORT AUX DIMENSIONS DE FABRICATION / HÖCHSTABWEICHUNG DER RECHTWINKELIGKEIT IM VERHÄLTNIS ZU DEN ENTSPRECHENDEN HERSTELLMÄßEN IN PROZENTEN / DESVIACIÓN MÁXIMA DE LA ORTOGONALIDAD, EN TANTO POR CIENTO, EN RELACIÓN CON EL TAMAÑO DE FABRICACIÓN CORRESPONDIENTE.	Squadrato ISO 13006	±0,3%	±1,5mm	±0,20%	ISO 10545-2
	PLANARITÀ (CURVATURA DEL CENTRO, DELLO SPIGOLO E SVERGOLAMENTO) / FLATNESS (CURVING IN THE MIDDLE, CORNER AND WARPING) / PLANÉITÉ (COURBURE CENTRALE, DE L'ARÊTE ET GAUCHISSEMENT) / EBENFLÄCHIGKEIT (KRÜMMUNG DER MITTE, DER KANTE UND VERWINDUNG) / PLANITUD (CURVATURA DEL CENTRO, DE LA ARISTA Y ABARQUILLAMIENTO).	Squadrato ISO 13006	±0,4%	±1,8mm	±0,20%	ISO 10545-2
	QUALITÀ DELLA SUPERFICIE / SURFACE QUALITY / QUALITÉ DE LA SURFACE / QUALITÄT DER OBERFLÄCHE / CALIDAD DE LA SUPERFICIE.	Il 95% min delle piastrelle deve essere esente da difetti visibili. / At least 95% of the tiles must be free from visible flaws. 95% min des carreaux ne doivent présenter aucun défaut visible. Mindestens 95% der Fliesen müssen frei von sichtbaren min. / el 95% de las baldosas tiene que estar exento de defectos visibles.		CONFORME/CONFORMING CONFORME/KONFORM CONFORME	ISO 10545-2	
	MASSA D'ACQUA ASSORBITA IN % / % WATER ABSORPTION - MASSE D'EAU ABSORBÉE EN % / WASSERAUFNAHME IN % / MASA DE AGUA ABSORBIDA EN %	< 0,5%		valore medio 0,08%	ISO 10545-3	
	FORZA DI ROTTURA IN N (sp. < 7,5 mm) - BREAKING STRENGTH IN N (thickness < 7,5 mm) / FORCE DE RUPTURE EN N (ép. < 7,5 mm) / BRUCHLAST IN N (Dicke < 7,5 mm) / FUERZA DE ROTURA EN N (gr. < 7,5 mm).	≥ 700		valore medio 1350 Newton	ISO 10545-4	
	RESISTENZA ALLA FLESSIONE IN N/mm2 / N/mm2 FLEXURAL STRENGTH TEST / RESISTANCE A LA FLEXION EN N/mm2 / BIEGEFESTIGKEIT IN N/mm2 / RESISTENCIA A LA FLEXION EN N/mm2	35 MIN.		valore medio 52 N/mm2	ISO 10545-4	
	RESISTENZA ALL'ABRASIONE PROFONDA DELLE PIASTRELLE NON SMALTATE / RESISTANCE TO DEEP ABRASION OF UNGLAZED TILES / RESISTANCE A L'ABRASION PROFONDE DES CARREAUX NON ÉMAILLÉS / TIEFENABRIEBFESTIGKEIT UNGLASIRTER FLIESEN / RESISTENCIA A LA ABRASION PROFUNDA DE LAS BALDOSAS SIN ESMALTAR.	< 175 mm ³		valore medio 140 mm ³	ISO 10545-6	
	RESISTENZA AGLI SBALZI TERMICI / THERMAL SHOCKS RESISTANT / RESISTANCE AUX VARIATIONS THERMIQUES / TEMPERATURWECHSELBESTÄNDIGKEIT / RESISTENCIA AL CHOQUE TÉRMICO.	Metodo di prova disponibile / Available testing method Methode d'essai disponible / Verfügbare Prüfmethode Método de ensayo disponible		RESISTE - RESISTANT RESISTE - ERFÜLLT RESISTE	ISO 10545-9	
	RESISTENZA AL GELO / FROST RESISTANCE / RESISTANCE AU GEL / FROSTSICHERHEIT / RESISTENCIA A LA HELADA	RICHIESTA - REQUIRED REQUISE - GEFORDERT REQUERIDA		RESISTE - RESISTANT RESISTE - ERFÜLLT RESISTE	ISO 10545-12	
	RESISTENZA ALLE MACCHIE / RESISTANCE TO STAINING / RESISTANCE AUX TACHES / FLECKENABWEISEND / RESISTENCIA A LAS MANCHAS.	Metodo di prova disponibile / Available testing method Methode d'essai disponible / Verfügbare Prüfmethode Método de ensayo disponible		Classe 3	ISO 10545-14	
	RILASCIO DI SOSTANZE PERICOLOSE / RELEASE OF HAZARDOUS SUBSTANCES / REJET DE SUBSTANCES DANGEREUSES / FREISETZUNG GEFAHRLICHER STOFFE / LIBERACION DE SUSTANCIAS PELIGROSAS / CADMIO (in mg/dm ²) - PIOMBO (in mg/dm ²)	VALORE DICHIARATO PER SUPERFICIE GL. CON IMPIEGHI SUI PIANI DI LAVORO / DECLARED VALUE FOR GL. SURFACES USED ON WORKTOPS / WERT DER ERKLÄRT FÜR OBERFLÄCHEN ZUM GEBRAUCH ALS ARBEITSPLATTEN / VALOR DECLARADO PARA ACABADOS GL. UTILIZADOS PARA SUPERFICIES DE TRABAJO.		CONFORME/CONFORMING CONFORME/KONFORM CONFORME	DM-1-2-2007-Reg-CE-1935-2004	
	RESISTENZA A BASSE CONCENTRAZIONI DI ACIDI E ALCALI. / RESISTANCE TO LOW CONCENTRATIONS OF ACIDS AND ALKALIS. / RESISTANCE A BASSES CONCENTRATIONS D'ACIDES ET ALCALIS. / WIDERSTAND GEGEN NIEDRIGE KONZENTRATIONEN VON SAUREN UND LAUGEN. / RESISTENCIA A BAJAS CONCENTRACIONES DE ACIDOS Y ALCALIS.	COME DICHIARATO DAL PRODUTTORE SEE MANUFACTURERS DECLARATION SELON DÉCLARATION DU PRODUCTEUR ENTSPRECHEND DER HERSTELLERANGABEN TAL COMO DECLARA EL FABRICANTE		ULB	ISO 10545-13	
	RESISTENZA A ALTE CONCENTRAZIONI DI ACIDI ED ALCALI / RESISTANCE TO HIGH CONCENTRATIONS OF ACIDS AND ALKALIS / RESISTANCE A HAUTES CONCENTRATIONS D'ACIDES ET BASES / BESTÄNDIGKEIT GEGEN STARK KONZENTRIERTE SAUREN UND LAUGEN / RESISTENCIA A ALTAS CONCENTRACIONES DE ACIDOS Y ALCALIS			UHB		
	RESISTENZA AI PRODOTTI CHIMICI DI USO DOMESTICO E AGLI ADDITIVI PER PISCINA / RESISTENCE TO DOMESTIC CHEMICAL PRODUCTS AND ADDITIVES FOR SWIMMING POOLS / RESISTANT AUX PRODUITS CHIMIQUES À USAGE DOMESTIQUE ET AUX ADDITIFS POUR PISCINE / WIDERSTAND GEGEN HAUSHALTSHEMIKALIEN UND / SCHWIMMBADZUSATZSTOFFEN / RESISTENCIA A PRODUCTOS PARA LIMPIEZA DOMESTICA Y ADITIVOS PARA PISCINAS	MIN B		UA		
	COEFFICIENTE D'ATTRITO (SCIVOLOSITÀ) / FRICTION COEFFICIENT (SLIPPERINESS) / COEFFICIENT DE FRICTION (GLISSEMENT) / REIBUNGSKOEFFIZIENT (SCHLUPFRIGKEIT) / COEFFICIENTE DE ANTI DESLIZAMIENTO.	-		> 0,42 wet	DCOF ANSI A 326.3	

Per un effetto ottimale della posa, florim suggerisce di mantenere 2 mm di fuga per pose monofornate e 3 mm per combinare formati misti / For optimal installation results, florim recommends maintaining a joint of 2 mm 1/16" for single format installations and 3 mm 1/8" to combine mixed formats / Pour réaliser une pose parfaite, florim suggère de maintenir 2 mm de joint pour la pose des monofornats, et 3 mm pour les combinaisons de formats mixtes / Um einen optimalen effekt beim verlegen zu erzielen empfiehlt florim eine 2 mm fugе bei einformatigen verlegungen und 3 mm fugе bei formatkombinationen / Para lograr los máximos resultados en la posa del producto, florim aconseja 2 mm de junta en aplicaciones monofornato y 3 mm en combinaciones de formatos mixtos.

NEUTRA 6.0 - COLORI

GRES PORCELLANATO DECORATO/DECORATED PORCELAIN TILES/GRÈS CÉRAMÉ DÉCORÉ /VERZIERTES FEINSTEINZEUG/GRES PORCELÁNICO DECORADO
SQUADRATO - SQUARED - EQUARRI - REKTIFFIZIERT - ESQUADRADO

6 mm 1/4"



CARATTERISTICHE TECNICHE - TECHNICAL CHARACTERISTICS - CARACTERISTIQUES TECHNIQUES - TECHNISCHE EIGENSCHAFTEN - CARACTERÍSTICAS TÉCNICAS						
	Caratteristiche di qualità secondo i tests di controllo previsti dalle norme EN 14411-ISO 13006 appendice G gruppo B1a GL Superficie Trattata / Quality characteristics according to the inspection tests envisaged by standard EN 14411-ISO 13006 appendix G group B1a GL Surface treatment / Caractéristiques de qualité selon les tests de contrôle prévus par les normes EN 14411-ISO 13006 appendice G groupe B1a GL Surface traitée / Qualitätseigenschaften gemäß den Kontrolltests der Normen EN 14411-ISO 13006, Anhang G Gruppe B1a GL behandelte Oberfläche / Características de calidad según los ensayos previstos por las normas EN 14411-ISO 13006 apéndice G grupo B1a GL Superficie tratada	PRESCRIZIONE STANDARD REQUIREMENTS PRESCRIPTIONS ANFORDERUNGEN PRESCRIPCION		RISULTATI TESTS TEST RESULTS RESULTATS DES ESSAIS PRÜFERGEBNIS RESULTADOS TESTS	RIFERIMENTO NORMA REFERENCE STANDARD RÉFÉRENCE NORME STANDARDWERT REFERENCIA NORMA	
		N ≥ 15 cm				
		(%)	(mm)			
	LUNGHEZZA E LARGHEZZA: DEVIAZIONE AMMISSIBILE, IN %, DELLA DIMENSIONE MEDIA DI OGNI PIASTRELLA DALLA DIM. DI FABBRICAZIONE / LENGTH AND WIDTH: ADMITTED DEVIATION, IN %, OF THE AVERAGE SIZE OF EACH TILE FROM THE PRODUCTION DIMENSIONS / LONGUEUR ET LARGEUR: MARGE DE TOLÉRANCE, EN %, ENTRE LA DIMENSION MOYENNE DE CHAQUE CARREAU ET LA DIM. DE FABRICATION / LANGE UND BREITE: ZULASSIGE ABWEICHUNG DES DURCHSCHNITTMÄßES JEDER FLIESE VOM HERSTELLMAß IN PROZENTEN / LARGO Y ANCHO: DESVIACION ADMISIBLE, EN %, DEL TAMAÑO MEDIO DE CADA BALDOSA A PARTIR DEL TAMAÑO DE FABRICACION.	Squadrato ISO 13006	±0,3%	±1,0 mm	±0,15%	
	DEVIAZIONE AMMISSIBILE, IN PERCENTO, DELLO SPESORE MEDIO DI OGNI PIASTRELLA DALLA DIMENSIONE DI FABBRICAZIONE / ADMITTED DEVIATION, IN %, OF THE AVERAGE THICKNESS OF EACH TILE FROM THE PRODUCTION DIMENSIONS / MARGE DE TOLÉRANCE, EN POURCENTAGE, ENTRE L'ÉPAISSEUR MOYENNE DE CHAQUE CARREAU ET LA DIMENSION DE FABRICATION / ZULASSIGE ABWEICHUNG DER DURCHSCHNITTSDICKE JEDER FLIESE VOM HERSTELLMAß IN PROZENTEN / DESVIACION ADMISIBLE, EN TANTO POR CIENTO, DEL GROSOR MEDIO DE CADA BALDOSA A PARTIR DEL TAMAÑO DE FABRICACION.	-	±5%	±0,5 mm	±5%	
	DEVIAZIONE MASSIMADI RETTILINEARITÀ, IN PERCENTO, IN RAPPORTO ALLE DIMENSIONI DI FABBRICAZIONE CORRISPONDENTI / MAXIMUM STRAIGHTNESS DEVIATION, IN %, IN RELATION TO THE CORRESPONDING PRODUCTION DIMENSIONS / MARGE DE TOLÉRANCE DE RECTITUDE, PAR RAPPORT AUX DIMENSIONS DE FABRICATION CORRESPONDANTES / ZULÄSSIGE HOCHSTABWEICHUNG DER KANTENGERADHEIT IM VERHÄLTNIS ZU DEN ENTSPRECHENDEN HERSTELLMAßEN IN PROZENTEN / DESVIACION MÁXIMADE RECTITUD, EN TANTO POR CIENTO, EN RELACION CON EL TAMAÑO DE FABRICACION CORRESPONDIENTE.	Squadrato ISO 13006	±0,3%	±0,8 mm	±0,1%	ISO 10545-2
	DEVIAZIONE MASSIMADI ORTOGONALITÀ, IN PERCENTO, IN RAPPORTO ALLE DIMENSIONI DI FABBRICAZIONE CORRISPONDENTI / MAXIMUM RIGHT-ANGLE DEVIATION, IN %, IN RELATION TO THE CORRESPONDING PRODUCTION DIMENSIONS / MARGE DE TOLÉRANCE D'ANGULARITÉ, EN POURCENTAGE, PAR RAPPORT AUX DIMENSIONS DE FABRICATION / HOCHSTABWEICHUNG DER RECHTWINKLIGKEIT IM VERHÄLTNIS ZU DEN ENTSPRECHENDEN HERSTELLMAßEN IN PROZENTEN / DESVIACION MÁXIMA DE LA ORTOGONALIDAD, EN TANTO POR CIENTO, EN RELACION CON EL TAMAÑO DE FABRICACION CORRESPONDIENTE.	Squadrato ISO 13006	±0,3%	±1,5 mm	±0,2%	
	PLANARITÀ (CURVATURA DEL CENTRO, DELLO SPIGOLO E SVERGOLAMENTO) / FLATNESS (CURVING IN THE MIDDLE, CORNER AND WARPING) / PLANÉTE (COURBURE CENTRALE, DE L'ARÊTE ET GAUCHISSEMENT) / EBENFLÄCHIGKEIT (KRÜMMUNG DER MITTE, DER KANTE UND VERWINDUNG) / PLANITUD (CURVATURA DEL CENTRO, DE LA ARISTA Y ABARQUILLAMIENTO).	Squadrato ISO 13006	±0,4%	±1,8 mm	±0,2%	
	QUALITÀ DELLA SUPERFICIE / SURFACE QUALITY / QUALITÉ DE LA SURFACE / QUALITÄT DER OBERFLÄCHE / CALIDAD DE LA SUPERFICIE.	Il 95% min delle piastrelle deve essere esente da difetti visibili. / At least 95% of the tiles must be free from visible flaws. 95% min des carreaux ne doivent présenter aucun défaut visible. Mindestens 95% der Fliesen müssen frei von sichtbaren min. / el 95% de las baldosas tiene que estar exento de defectos visibles		CONFORME/CONFORMING CONFORME/CONFORM CONFORME		
	MASSA D'ACQUA ASSORBITA IN % / % WATER ABSORPTION - MASSE D'EAU ABSORBÉE EN % / WASSERAUFNAHME IN % / MASA DE AGUA ABSORBIDA EN %		< 0,5%		valore medio 0,08%	ISO 10545-3
	FORZA DI ROTTURA IN N (sp. < 7,5 mm) - BREAKING STRENGTH IN N (thickness < 7,5 mm) / FORCE DE RUPTURE EN N (ép. < 7,5 mm) / BRUCHLAST IN N (Dicke < 7,5 mm) / FUERZA DE ROTURA EN N (gr. < 7,5 mm)		≥ 700		valore medio 1350 Newton	ISO 10545-4
	RESISTENZA ALLA FLESSIONE IN N/mm2 / N/mm2 FLEXURAL STRENGTH TEST / RÉSISTANCE A LA FLEXION EN N/mm2 / BIEGEFESTIGKEIT IN N/mm / RESISTENCIA A LA FLEXION EN N/mm		35 MIN.		valore medio 52 N/mm2	ISO 10545-4
	RESISTENZA ALL'ABRASIONE / RESISTANCE TO ABRASION / RÉSISTANCE À L'ABRASION / ABRIEFBFAST RESISTENCIA A LA ABRASIÓN	COME DICHIARATO DAL PRODUTTORE SEE MANUFACTURERS DECLARATION SELON DECLARATION DU PRODUCTEUR ENTSPRECHEND DER HERSTELLERANGABEN TAL COMO DECLARA EL FABRICANTE			N.A.	ISO 10545-7
	RESISTENZA AL CAVILLO DELLE PIASTRELLE SMALTATE / RESISTANCE TO CRAZING OF GLAZED TILES / RÉSISTANCE À LA CRAQUELURE POUR LES CARRE AUX ÉMAILLÉS / WIDERSTAND GEGEN HAARRISS VON GLASIRTER FLIESEN / RESISTENCIA AL CUARTEADO DE LOS AZULEJOS ESMALTADOS		RICHIESTA - REQUIRED REQUIRE - GEFORDERT REQUERIDA		RESISTE - RESISTANT RÉSISTE - ERFÜLLT RESISTE	ISO 10545-11
	RESISTENZA AL GELO / FROST RESISTANCE / RÉSISTANCE AU GEL / FROSTSICHERHEIT RESISTENCIA A LA HELADA		RICHIESTA - REQUIRED REQUIRE - GEFORDERT REQUERIDA		RESISTE - RESISTANT RÉSISTE - ERFÜLLT RESISTE	ISO 10545-12
	RESISTENZA ALLE MACCHIE / RESISTANCE TO STAINING / RÉSISTANCE AUX TACHES FLECKENABWEISEND / RESISTENCIA A LAS MANCHAS.		Metodo di prova disponibile / Available testing method Méthode d'essai disponible / Verfügbare Prüfmethode Método de ensayo disponible		3-4	ISO 10545-14
	RESISTENZA A BASSE CONCENTRAZIONI DI ACIDI E ALCALI. RESISTANCE TO LOW CONCENTRATIONS OF ACIDS AND ALKALIS. RESISTENCIA A BASSAS CONCENTRACIONES D'ACIDOS Y ALCALIS. WIDERSTAND GEGEN NIEDRIGE KONZENTRATIONEN VON SAUREN UND LAUGEN. / RESISTENCIA A BAJAS CONCENTRACIONES DE ACIDOS Y ALCALIS.		COME DICHIARATO DAL PRODUTTORE SEE MANUFACTURERS DECLARATION SELON DECLARATION DU PRODUCTEUR ENTSPRECHEND DER HERSTELLERANGABEN TAL COMO DECLARA EL FABRICANTE		acido cloridrico/hydrochloric acid acide chlorhydrique/Salzsäure ácido clorhídrico GLB acido citrico/citric acid/acide citrique Zitronensäure/ácido cítrico GLB idrossido di potassio/potassium hydroxide hydroxyde de potassium/Kaliumhydroxid Hidróxido de potasio GLC	ISO 10545-13
	RESISTENZA AI PRODOTTI CHIMICI DI USO DOMESTICO E AGLI ADDITIVI PER PISCINA RESISTENCE TO DOMESTIC CHEMICAL PRODUCTS AND ADDITIVES FOR SWIMMING POOLS RESISTANT AUX PRODUITS CHIMIQUES À USAGE DOMESTIQUE ET AUX ADDITIFS POUR PISCINE WIDERSTAND GEGEN HAUSHALTSCHENIKALIEN UND SCHWIMMBADZUSATZSTOFFEN RESISTENCIA A PRODUCTOS PARA LIMPIEZA DOMESTICA Y ADITIVOS PARA PISCINAS		MIN B		GA	

Lastre decorate destinate esclusivamente al rivestimento di pareti interne./Decorated panels designed exclusively for tiling interior walls./ Dalles décorées, exclusivement destinées au revêtement de parois intérieures./ Verzierte Platten, ausschließlich zur Verkleidung von Innenwänden bestimmt./ Losas decoradas destinadas exclusivamente al revestimiento de paredes interiores.

N.A. Non applicabile per la destinazione d'uso prevista - N.A. Not applicable to the intended use. - ND Non disponible pour l'utilisation prévue. - Nicht anwendbar für den vorgesehenen Einsatz - No aplicable para el uso previsto

GRES FINE PORCELLANATO/FINE PORCELAIN STONEWARE/GRES CERAME FIN/FEINSTEINZEUG-KOLLEKTIONEN/GRES PORCELANICO FINO
SQUADRATO - SQUARED - EQUARRI - REKTIFFIZIERT - ESCUADRADO

CARATTERISTICHE TECNICHE - TECHNICAL CHARACTERISTICS - CARACTERISTIQUES TECHNIQUES - TECHNISCHE EIGENSCHAFTEN - CARACTERÍSTICAS TÉCNICAS		PRESCRIZIONE STANDARD REQUIREMENTS PRESCRIPTIONS ANFORDERUNGEN PRESCRIPCION		RISULTATI TESTS TEST RESULTS RESULTATS DES ESSAIS PRÜFERGEBNIS RESULTADOS TESTS		RIFERIMENTO NORMA REFERENCE STANDARD STANDARDWERT REFERENCIA NORMA
		N ≥ 15 cm		N ≥ 15 cm		
		(%)	(mm)	matte	R+PTV	
Lastre in gres fine porcellanato non smaltato. Piastrelle di ceramica pressate a secco. Caratteristiche di qualità secondo i test di controllo previsti dalla norma EN 14411-ISO 13006 Appendice G gruppo Bia UGL / Unglazed porcelain stoneware slabs. Dry-pressed ceramic tiles. Quality specifications, according to control tests of EN 14411-ISO 13006 Appendix G group Bia UGL. / Dalles en grès cérame fin non émaillé. Carreaux céramiques pressés à sec. Caractéristiques de qualité d'après les essais de contrôle norme EN 14411-ISO 13006 Appendice G groupe Bia UGL. / Nicht glasierte und vollständig gesinterte Feinsteinzeugplatten. Trocken gepresste Keramikfliesen. Qualitätseigenschaften nach Normen EN 14411-ISO 13006 Anhang G Gruppe Bia UGL. / Planchas de gres porcelánico fino no esmaltado. Baldosas de cerámica remasadas en seco. Características de calidad según las Normas EN 14411-ISO 13006 Apéndice G grupo Bia UGL.		Squadrato ISO 13006	±0,3%	±1,0mm	±0,15%	ISO 10545-2
LUNGHEZZA E LARGHEZZA: DEVIAZIONE AMMISSIBILE, IN %, DELLA DIMENSIONE MEDIA DI OGNI PIASTRELLA DALLA DIM. DI FABBRICAZIONE / LENGTH AND WIDTH: ADMITTED DEVIATION, IN %, OF THE AVERAGE SIZE OF EACH TILE FROM THE PRODUCTION DIMENSIONS / MARGE DE TOLERANCE, EN POURCENTAGE, ENTRE LA DIMENSION MOYENNE DE CHAQUE CARREAU ET LA DIM. DE FABRICATION / LÄNGE UND BREITE: ZULÄSSIGE ABWEICHUNG DES DURCHSCHNITTMÄßES JEDER FLIESE VOM HERSTELLMAß IN PROZENTEN / LARGO Y ANCHO: DESVIACION ADMISIBLE, EN %, DEL TAMAÑO MEDIO DE CADA BALDOSA A PARTIR DEL TAMAÑO DE FABRICACION.		-	±5%	±0,5mm	±5%	ISO 10545-2
DEVIAZIONE AMMISSIBILE, IN PERCENTO, DELLO SPESSORE MEDIO DI OGNI PIASTRELLA DALLA DIMENSIONE DI FABBRICAZIONE / ADMITTED DEVIATION, IN %, OF THE AVERAGE THICKNESS OF EACH TILE FROM THE PRODUCTION DIMENSIONS / MARGE DE TOLERANCE, EN POURCENTAGE, ENTRE L'ÉPAISSEUR MOYENNE DE CHAQUE CARREAU ET LA DIMENSION DE FABRICATION / ZULÄSSIGE ABWEICHUNG DER DURCHSCHNITTSDICKE JEDER FLIESE VOM HERSTELLMAß IN PROZENTEN / DESVIACION ADMISIBLE, EN TANTO POR CIENTO, DEL GROSOR MEDIO DE CADA BALDOSA A PARTIR DEL TAMAÑO DE FABRICACION.		Squadrato ISO 13006	±0,3%	±0,8mm	±0,10%	ISO 10545-2
DEVIAZIONE MASSIMA DI RETTILINEARITÀ IN PERCENTO, IN RAPPORTO ALLE DIMENSIONI DI FABBRICAZIONE / CORRESPONDENT / MAXIMUM STRAIGHTNESS DEVIATION, IN %, IN RELATION TO THE CORRESPONDING PRODUCTION DIMENSIONS / MARGE DE TOLERANCE DE RECTITUDE, EN POURCENTAGE, PAR RAPPORT AUX DIMENSIONS DE FABRICATION / HÖCHSTABWEICHUNG DER KANTENGERADHEIT IM VERHÄLTNIß ZU DEN ENTSPRECHENDEN HERSTELLMAßEN IN PROZENTEN / DESVIACION MÁXIMA DE RECTITUD, EN TANTO POR CIENTO, EN RELACION CON EL TAMAÑO DE FABRICACION CORRESPONDIENTE.		Squadrato ISO 13006	±0,3%	±1,5mm	±0,20%	ISO 10545-2
DEVIAZIONE MASSIMA DI ORTOGONALITÀ IN PERCENTO, IN RAPPORTO ALLE DIMENSIONI DI FABBRICAZIONE / CORRESPONDENT / MAXIMUM RIGHT-ANGLE DEVIATION, IN %, IN RELATION TO THE CORRESPONDING PRODUCTION DIMENSIONS / MARGE DE TOLERANCE D'ANGULARITÉ, EN POURCENTAGE, PAR RAPPORT AUX DIMENSIONS DE FABRICATION / HÖCHSTABWEICHUNG DER RECHTWINKLIGKEIT IM VERHÄLTNIß ZU DEN ENTSPRECHENDEN HERSTELLMAßEN IN PROZENTEN / DESVIACION MÁXIMA DE LA ORTOGONALIDAD, EN TANTO POR CIENTO, EN RELACION CON EL TAMAÑO DE FABRICACION CORRESPONDIENTE.		Squadrato ISO 13006	±0,4%	±1,8mm	±0,20%	ISO 10545-2
PLANARITÀ (CURVATURA DEL CENTRO, DELLO SPIGOLO E SVERGOLAMENTO) / FLATNESS (CURVING IN THE MIDDLE, CORNER AND WARPING) / PLANÉITÉ (COURBURE CENTRALE, DE L'ARÊTE ET GAUCHISSEMENT) / EBENFLÄCHIGKEIT (KRÜMMUNG DER MITTE, DER KANTE UND VERWÜNDUNG) / PLANITUD (CURVATURA DEL CENTRO, DE LA ARISTA Y ABARQUILLAMIENTO).		Squadrato ISO 13006	±0,4%	±1,8mm	±0,20%	ISO 10545-2
QUALITÀ DELLA SUPERFICIE / SURFACE QUALITY / QUALITÉ DE LA SURFACE / QUALITÄT DER OBERFLÄCHE / CALIDAD DE LA SUPERFICIE.		Il 95% min delle piastrelle deve essere esente da difetti visibili. / At least 95% of the tiles must be free from visible flaws. 95% min des carreaux ne doivent présenter aucun défaut visible. Mindestens 95% der Fliesen müssen frei von sichtbaren min. / el 95% de las baldosas tiene que estar exento de defectos visibles.		CONFORME/CONFORMING CONFORME/KONFORM CONFORME		ISO 10545-2
MASSA D'ACQUA ASSORBITA IN % / % WATER ABSORPTION - MASSE D'EAU ABSORBÉE EN % / WASSERAUFNAHME IN % / MASA DE AGUA ABSORBIDA EN %		< 0,5%		valore medio 0,08%		ISO 10545-3
FORZA DI ROTTURA IN N (sp. < 7,5 mm) - BREAKING STRENGTH IN N (thickness < 7,5 mm) / FORCE DE RUPTURE EN N (épais. < 7,5 mm) / BRUCHLAST IN N (Dicke < 7,5 mm) / FUERZA DE ROTURA EN N (gr. < 7,5 mm).		≥ 700		valore medio 1350 Newton		ISO 10545-4
RESISTENZA ALLA FLESSIONE IN N/mm2 / N/mm2 FLEXURAL STRENGTH TEST / RESISTENCIA A LA FLEXION EN N/mm2 / BIEGEFESTIGKEIT IN N/mm2 / RESISTENCIA A LA FLEXION EN N/mm2		35 MIN.		valore medio 52 N/mm2		ISO 10545-4
RESISTENZA ALL'ABRAZIONE PROFONDA DELLE PIASTRELLE NON SMALTATE / RESISTANCE TO DEEP ABRASION OF UNGLAZED TILES / RESISTANCE A L'ABRASION PROFONDE DES CARREAUX NON EMAILLÉS / TIEFENABRIEFESTIGKEIT UNGLASIRTER FLIESEN / RESISTENCIA A LA ABRASION PROFUNDA DE LAS BALDOSAS SIN ESMALTAR.		< 175 mm³		valore medio 140 mm³		ISO 10545-6
RESISTENZA AGLI SBALZI TERMICI / THERMAL SHOCKS RESISTANT / RESISTANCE AUX VARIATIONS THERMIQUES / TEMPERATURWECHSELBESTÄNDIGKEIT / RESISTENCIA AL CHOQUE TERMICO.		Metodo di prova disponibile / Available testing method Méthode d'essai disponible / Verfügbare Prüfmethode Método de ensayo disponible		RESISTE - RÉSISTANT RESISTE - ERFÜLLT RESISTE		ISO 10545-9
RESISTENZA AL GELO / FROST RESISTANCE / RESISTANCE AU GEL / FROSTSICHERHEIT RESISTENCIA A LA HELADA		RICHIESTA - REQUIRED REQUIRE - GEFORDERT REQUERIDA		RESISTE - RÉSISTANT RESISTE - ERFÜLLT RESISTE		ISO 10545-12
RESISTENZA ALLE MACCHIE / RESISTANCE TO STAINING / RESISTANCE AUX TACHES / FLECKENABWEISEND / RESISTENCIA A LAS MANCHAS.		Metodo di prova disponibile / Available testing method Méthode d'essai disponible / Verfügbare Prüfmethode Método de ensayo disponible		Classe 4		ISO 10545-14
RILASCIO DI SOSTANZE PERICOLOSE / RELEASE OF HAZARDOUS SUBSTANCES / REJET DE SUBSTANCES DANGEREUSES / FREISETZUNG GEFAHRLICHER STOFFE / LIBERACION DE SUSTANCIAS PELIGROSAS / CADMIO (in mg/dm²) - PIOMBO (in mg/dm²)		VALORE DICHIARATO PER SUPERFICI GL CON IMPRESI SU PAVI DI LAVORO / DECLARED VALUE FOR GL SURFACES USED ON WORKTOPS / VALEUR DÉCLARÉE POUR SURFACES GL UTILISÉES SUR PLANS DE TRAVAIL / ANGEBOBENWEIS WERT FÜR GL OBERFLÄCHEN ZUM GEBRAUCH ALS ARBEITSPLATZEN / VALOR DECLARADO PARA ACABADOS GL UTILIZADOS PARA SUPERFICIES DE TRABAJO		CONFORME/CONFORMING CONFORME/KONFORM CONFORME		DM-1-2-2007-Reg- CE-1935-2004
RESISTENZA A BASSE CONCENTRAZIONI DI ACIDI E ALCALI / RESISTANCE TO LOW CONCENTRATIONS OF ACIDS AND ALKALIS. / RESISTANCE A BASSES CONCENTRATIONS D'ACIDES ET ALCALIS. / WIDERSTAND GEGEN NIEDRIGE KONZENTRATIONEN VON SAUREN UND LAUGEN. / RESISTENCIA A BAJAS CONCENTRACIONES DE ACIDOS Y ALCALIS.		COME DICHIARATO DAL PRODUTTORE SEE MANUFACTURER'S DECLARATION SELON DECLARATION DU PRODUCTEUR ENTSPRECHEND DER HERSTELLERANGABEN TAL COMO DECLARA EL FABRICANTE		ULA-ULB		ISO 10545-13
RESISTENZA AI PRODOTTI CHIMICI DI USO DOMESTICO E AGLI ADDITIVI PER PISCINA / RESISTENCE TO DOMESTIC CHEMICAL PRODUCTS AND ADDITIVES FOR SWIMMING POOLS / RESISTANT AUX PRODUITS CHIMIQUES A USAGE DOMESTIQUE ET AUX ADDITIFS POUR PISCINE / WIDERSTAND GEGEN HAUSHALTSCHEMIKALIEN UND / SCHWIMMBADZUSATZSTOFFEN / RESISTENCIA A PRODUCTOS PARA LIMPIEZA DOMESTICA Y ADITIVOS PARA PISCINAS		MIN B		UA		
COEFFICIENTE D'ATTRITO (SCIVOLosità) / FRICTION COEFFICIENT (SLIPPERINESS) / COEFFICIENT DE FRICTION (GLISSEMENT) / REIBUNGSKOEFFIZIENT (SCHLUPFRIGKEIT) / COEFFICIENTE DE ANTI DESLIZAMIENTO.		-		10° ≤ α < 19° R10		DIN EN 16165 ANNEX B
		-		18° ≤ α < 24° classe B		DIN EN 16165 ANNEX A
		-		PTV > 36 wet slider 4S		BS EN 16165 ANNEX C
		-		> 0,42 wet		DCOF ANSI A 326.3

Per un effetto ottimale della posa, florim suggerisce di mantenere 2 mm di fuga per pose monoformato e 3 mm per combinare formati misti / For optimal installation results, florim recommends maintaining a joint of 2 mm 1/16" for single format installations and 3 mm 1/8" to combine mixed formats / Pour réaliser une pose optimale, florim suggère de maintenir 2 mm de joint pour la pose des monoformats, et 3 mm pour les combinaisons de formats mixtes / Um einen optimalen effekt beim verlegen zu erzielen empfehlt florim eine 2 mm fuge bei einformatigen verlegungen und 3 mm fuge bei formatkombinationen / Para lograr los máximos resultados en la posa del producto, florim aconseja 2 mm de junta en aplicaciones monoformato y 3 mm en combinaciones de formatos mixtos.

NATURE MOOD

GRES FINE PORCELLANATO/FINE PORCELAIN STONEWARE/GRES CERAME FIN/FEINSTEINZEUG-KOLLEKTIONEN/GRES PORCELANADO FINO
SQUADRATO - SQUARED - EQUARRI - REKTIFIZIERT - ESCUADRADO

6 mm 1/4"











CARATTERISTICHE TECNICHE - TECHNICAL CHARACTERISTICS - CARACTERISTIQUES TECHNIQUES - TECHNISCHE EIGENSCHAFTEN - CARACTERÍSTICAS TÉCNICAS								
Lastre in gres fine porcellanato non smaltato. Piastrelle di ceramica pressate a secco. Caratteristiche di qualità secondo i test di controllo previsti dalla norma EN 14411-ISO 13006 Appendice G gruppo Bia UGL. / Unglazed porcelain stoneware slabs. Dry-pressed ceramic tiles. Quality specifications, according to control tests of EN 14411-ISO 13006 Appendix G group Bia UGL. / Dalles en grès cérame fin non émaillé. Carreaux céramiques pressés à sec. Caractéristiques de qualité d'après les essais de contrôle norme EN 14411-ISO 13006 Appendice G groupe Bia UGL. / Nicht glasierte und vollständig gesinterter Feinsteinzeugplatten. Trocken gepresste Keramikfliesen. Qualitätseigenschaften nach Normen EN 14411-ISO 13006 Anhang G Gruppe Bia UGL. / Planchas de grés porcelánico fino no esmaltado. Baldosas de cerámica resadas en seco. Características de calidad según las Normas EN 14411-ISO 13006 Apéndice G grupo Bia UGL.		PRESCRIZIONE STANDARD REQUIREMENTS PRESCRIPTIONS ANFORDERUNGEN PRESCRIPCION		RISULTATI TESTS TEST RESULTS RESULTATS DES ESSAIS PRÜFERGEBNIS RESULTADOS TESTS		RIFERIMENTO NORMA REFERÉNCIA STANDARD RÉFÉRENCE NORME STANDARDWERT REFERENCIA NORMA		
		N ≥ 15 cm		N ≥ 15 cm				
		(%)	(mm)	comfort	glossy			
	LUNGHEZZA E LARGHEZZA: DEVIAZIONE AMMISSIBILE, IN % DELLA DIMENSIONE MEDIA DI OGNI PIASTRELLA DALLA DIM. DI FABBRICAZIONE / LENGTH AND WIDTH: ADMITTED DEVIATION, IN %, OF THE AVERAGE SIZE OF EACH TILE FROM THE PRODUCTION DIMENSIONS / LONGUEUR ET LARGEUR : MARGE DE TOLERANCE, EN %, ENTRE LA DIMENSION MOYENNE DE CHAQUE CARREAU ET LA DIM. DE FABRICATION / LÄNGE UND BREITE: ZULÄSSIGE ABWEICHUNG DES DURCHSCHNITTMÄßES JEDER FLIESE VOM HERSTELLMAß IN PROZENTEN / LARGO Y ANCHO: DESVIACION ADMISIBLE, EN %, DEL TAMAÑO MEDIO DE CADA BALDOSA A PARTIR DEL TAMAÑO DE FABRICACIÓN.	Squadrato ISO 13006	±0,3%	±1,0mm	±0,15%		ISO 10545-2	
	DEVIAZIONE AMMISSIBILE, IN PERCENTO, DELLO SPESSORE MEDIO DI OGNI PIASTRELLA DALLA DIMENSIONE DI FABBRICAZIONE / ADMITTED DEVIATION, IN %, OF THE AVERAGE THICKNESS OF EACH TILE FROM THE PRODUCTION DIMENSIONS / MARGE DE TOLERANCE, EN POURCENTAGE, ENTRE L'ÉPAISSEUR MOYENNE DE CHAQUE CARREAU ET LA DIMENSION DE FABRICATION / ZULÄSSIGE ABWEICHUNG DER DURCHSCHNITTSDICKE JEDER FLIESE VOM HERSTELLMAß IN PROZENTEN / DESVIACION ADMISIBLE, EN TANTO POR CIENTO, DEL GROSOR MEDIO DE CADA BALDOSA A PARTIR DEL TAMAÑO DE FABRICACIÓN.	-	±5%	±0,5mm	±5%			ISO 10545-2
	DEVIAZIONE MASSIMA DI RETTILINEARITÀ, IN PERCENTO, IN RAPPORTO ALLE DIMENSIONI DI FABBRICAZIONE CORRESPONDENTI / MAXIMUM STRAIGHTNESS DEVIATION, IN %, IN RELATION TO THE CORRESPONDING PRODUCTION DIMENSIONS / MARGE DE TOLERANCE DE RECTITUDE, EN POURCENTAGE, PAR RAPPORT AUX DIMENSIONS DE FABRICATION CORRESPONDANTES / ZULÄSSIGE HOCHSTABWEICHUNG DER KANTENGERADHEIT IM VERHÄLTNIS ZU DEN ENTSPRECHENDEN HERSTELLMAßEN IN PROZENTEN / DESVIACION MÁXIMA DE RECTITUD, EN TANTO POR CIENTO, EN RELACION CON EL TAMAÑO DE FABRICACIÓN CORRESPONDIENTE.	Squadrato ISO 13006	±0,3%	±0,8mm	±0,10%			ISO 10545-2
	DEVIAZIONE MASSIMA DI ORTOGONALITÀ, IN PERCENTO, IN RAPPORTO ALLE DIMENSIONI DI FABBRICAZIONE CORRESPONDENTI MAXIMUM RIGHT-ANGLE DEVIATION, IN %, IN RELATION TO THE CORRESPONDING PRODUCTION DIMENSIONS / MARGE DE TOLERANCE D'ANGULARITÉ, EN POURCENTAGE, PAR RAPPORT AUX DIMESIONS DE FABRICATION / HOCHSTABWEICHUNG DER RECHTWINKELIGKEIT IM VERHÄLTNIS ZU DEN ENTSPRECHENDEN HERSTELLMAßEN IN PROZENTEN / DESVIACION MÁXIMA DE LA ORTOGONALIDAD, EN TANTO POR CIENTO, EN RELACION CON EL TAMAÑO DE FABRICACIÓN CORRESPONDIENTE.	Squadrato ISO 13006	±0,3%	±1,5mm	±0,20%			ISO 10545-2
	PLANARITÀ (CURVATURA DEL CENTRO, DELLO SPIGOLO E SVERGOLAMENTO) / FLATNESS (CURVING IN THE MIDDLE, CORNER AND WARPING) / PLANÉITÉ (COURBURE CENTRALE, DE L'ARÊTE ET GAUCHISSEMENT) / EBENFLÄCHIGKEIT (KRÜMMUNG DER MITTE, DER KANTE UND VERWINDUNG) / PLANITUD (CURVATURA DEL CENTRO, DE LA ARISTA Y ABARQUILLAMIENTO).	Squadrato ISO 13006	±0,4%	±1,8mm	±0,20%			ISO 10545-2
	QUALITÀ DELLA SUPERFICIE / SURFACE QUALITY / QUALITÉ DE LA SURFACE / QUALITÄT DER OBERFLÄCHE / CALIDAD DE LA SUPERFICIE.			Il 95% min delle piastrelle deve essere esente da difetti visibili. / At least 95% of the tiles must be free from visible flaws. 95% min des carreaux ne doivent présenter aucun défaut visible. Mindestens 95% der Fliesen müssen frei von sichtbaren min. / el 95% de las baldosas tiene que estar exento de defectos visibles.		CONFORME/CONFORMING CONFORME/KONFORM CONFORME		ISO 10545-2
	MASSA D'ACQUA ASSORBITA IN % / % WATER ABSORPTION - MASSE D'EAU ABSORBÉE EN % / WASSERAUFNAHME IN % / MASA DE AGUA ABSORBIDA EN %		< 0,5%		valore medio 0,08%		ISO 10545-3	
	FORZA DI ROTTURA IN N (sp. < 7,5 mm) - BREAKING STRENGTH IN N (thickness < 7,5 mm) / FORCE DE RUPTURE EN N (épais. < 7,5 mm) / BRUCHLAST IN N (Dicke < 7,5 mm) / FUERZA DE ROTURA EN N (gr. < 7,5 mm).		≥ 700		valore medio 1350 Newton		ISO 10545-4	
	RESISTENZA ALLA FLESSIONE IN N/mm2 / N/mm2 FLEXURAL STRENGTH TEST / RESISTENCIA A LA FLEXION EN N/mm2		35 MIN.		valore medio 52 N/mm2		ISO 10545-4	
	RESISTENZA ALL'ABRAZIONE PROFONDA DELLE PIASTRELLE NON SMALTATE / RESISTANCE TO DEEP ABRASION OF UNGLAZED TILES / RESISTANCE A L'ABRASION PROFONDE DES CARREAUX NON ÉMALLÉS / TIEFENABRIEBESTIGKEIT UNGLASIRTER FLIESEN / RESISTENCIA A LA ABRASION PROFUNDA DE LAS BALDOSAS SIN ESMALTAR.		< 175 mm ³		valore medio 140 mm ³		ISO 10545-6	
	RESISTENZA AGLI SBALZI TERMICI / THERMAL SHOCKS RESISTANT / RESISTANCE AUX VARIATIONS THERMIQUES / TEMPERATURWECHSELBESTÄNDIGKEIT / RESISTENCIA AL CHOQUE TÉRMICO.		Metodo di prova disponibile / Available testing method Méthode d'essai disponible / Verfügbare Prüfmethode Método de ensayo disponible		RESISTE - RESISTANT RÉSISTE - ERFÜLLT RESISTE		ISO 10545-9	
	RESISTENZA AL GELO / FROST RESISTANCE / RÉSISTANCE AU GEL / FROSTSICHERHEIT / RESISTENCIA A LA HELADA		RICHIESTA - REQUIRED REQUIRE - GEFORDERT REQUERIDA		RESISTE - RESISTANT RÉSISTE - ERFÜLLT RESISTE		ISO 10545-12	
	RESISTENZA ALLE MACCHIE / RESISTANCE TO STAINING / RÉSISTANCE AUX TACHES / FLECKENABWEISEND / RESISTENCIA A LAS MANCHAS.		Metodo di prova disponibile / Available testing method Méthode d'essai disponible / Verfügbare Prüfmethode Método de ensayo disponible		Classe 5	Classe 4-5	ISO 10545-14	
	RILASCIO DI SOSTANZE PERICOLOSE / RELEASE OF HAZARDOUS SUBSTANCES / REJET DE SUBSTANCES DANGEREUSES / FREISZUNG GEFÄHRLICHER STOFFE / LIBERACION DE SUSTANCIAS PELIGROSAS / CADMIO (in mg/dm ²) - PIOMBO (in mg/dm ²)		VALORE DICHIARATO PER SUPERFICIE GL. CON IMPIEGHI SU PIANI DI LAVORO / DECLARED VALUE FOR GL SURFACES USED ON WORKTOPS / VALEUR DÉCLARÉE POUR SURFACES GL UTILISÉES SUR PLANS DE TRAVAIL / ANGEZEIGTES WERT FÜR GL OBERFLÄCHEN ZUM GEBRAUCH ALS ARBEITSPLÄTTE / VALOR DECLARADO PARA ACABADOS GL UTILIZADOS PARA SUPERFICIES DE TRABAJO		CONFORME/CONFORMING CONFORME/KONFORM CONFORME		DM-1-2-2007-Reg-CE-1935-2004	
	RESISTENZA A BASSE CONCENTRAZIONI DI ACIDI E ALCALI. / RESISTANCE TO LOW CONCENTRATIONS OF ACIDS AND ALKALIS. / RESISTANCE A BASSES CONCENTRATIONS D'ACIDES ET ALCALIS. / WIDERSTAND GEGEN NIEDRIGE KONZENTRATIONEN VON SAUREN UND LAUGEN. / RESISTENCIA A BAJAS CONCENTRACIONES DE ACIDOS Y ALCALIS.		COME DICHIARATO DAL PRODUTTORE SEE MANUFACTURER'S DECLARATION SELON DÉCLARATION DU PRODUCTEUR ENTSPRECHEND DER HERSTELLERANGABEN TAL COMO DECLARA EL FABRICANTE		ULA	ULA-ULB	ISO 10545-13	
	RESISTENZA AI PRODOTTI CHIMICI DI USO DOMESTICO E AGLI ADDITIVI PER PISCINA / RESISTENCE TO DOMESTIC CHEMICAL PRODUCTS AND ADDITIVES FOR SWIMMING POOLS / RESISTANT AUX PRODUITS CHIMIQUES À USAGE DOMESTIQUE ET AUX ADDITIFS POUR PISCINE / WIDERSTAND GEGEN HAUSHALTSHEMİKALIEN UND / SCHWIMMBADZUSATZSTOFFEN / RESISTENCIA A PRODUCTOS PARA LIMPIEZA DOMESTICA Y ADITIVOS PARA PISCINAS		MIN B		UA			
	COEFFICIENTE D'ATTRITO (SCIVOLOSITÀ) / FRICTION COEFFICIENT (SLIPPERINESS) / COEFFICIENT DE FRICTION (GLISSEMENT) / REIBUNGSKOEFFIZIENT (SCHLUPFRIGKEIT) / COEFICIENTE DE ANTI DESLIZAMIENTO.		-		10° ≤ α < 19° R10	-	DIN EN 16165 ANNEX B	
			-		18° ≤ α < 24° classe B	-	DIN EN 16165 ANNEX A	
			-		PTV > 36 wet slider 4S	-	BS EN 16165 ANNEX C	
			-		> 0,42 wet	-	ANSI A 326.3	

Per un effetto ottimale della posa, florim suggerisce di mantenere 2 mm di fuga per pose monofornate e 3 mm per combinare formati misti / For optimal installation results, florim recommends maintaining a joint of 2 mm 1/16" for single format installations and 3 mm 1/8" to combine mixed formats / Pour réaliser une pose parfaite, florim suggère de maintenir 2 mm de joint pour la pose des monofornats et 3 mm pour les combinaisons de formats mixtes / Um einen optimalen effekte beim verlegen zu erzielen empfiehlt florim eine 2 mm fuge bei einformatigen verlegungen und 3 mm fuge bei formatkombinationen / Para lograr los máximos resultados en la posa del producto, florim aconseja 2 mm de junta en aplicaciones monofornato y 3 mm en combinaciones de formatos mixtos.

CARATTERISTICHE TECNICHE

TECHNICAL FEATURES
CARACTÉRISTIQUES TECHNIQUES
TECHNISCHE EIGENSCHAFTEN
CARACTERISTICAS TÉCNICAS

9mm

CARATTERISTICHE TECNICHE - TECHNICAL CHARACTERISTICS - CARACTERISTIQUES TECHNIQUES - TECHNISCHE EIGENSCHAFTEN - CARACTERÍSTICAS TÉCNICAS						
	Lastre in gres fine porcellanato non smaltato. Piastrelle di ceramica pressate a secco. Caratteristiche di qualità secondo i test di controllo previsti dalla norma EN 14411-ISO 13006 Appendice G gruppo Bia UGL/ Unglazed porcelain stoneware slabs. Dry-pressed ceramic tiles. Quality specifications, according to control tests of EN 14411-ISO 13006 Appendix G group Bia UGL. / Dalles en grès cérame fin non émailié. Carreaux céramiques pressés à sec. Caractéristiques de qualité d'après les essais de contrôle norme EN 14411-ISO 13006 Appendice G groupe Bia UGL/ Nicht glasierte und vollständig gesinterte Feinsteinzeugplatten. Trocken gepresste Keramikfliesen. Qualitätseigenschaften nach Normen EN 14411-ISO 13006 Anhang G Gruppe Bia UGL/ Planchas de gres porcelánico fino no esmaltado. Baldosas de cerámica resnadas en seco. Características de calidad según las Normas EN 14411-ISO 13006 Apéndice G grupo B1a UGL.	PRESCRIZIONE STANDARD REQUIREMENTS PRESCRIPTIONS ANFORDERUNGEN PRESCRIPCION	RISULTATI TESTS TEST RESULTS RESULTATS DES ESSAIS PRÜFERGEBNIS RESULTADOS TESTS	RIFERIMENTO NORMA REFERENCE STANDARD RÉFÉRENCE NORME STANDARDWERT REFERENCIA NORMA		
		N > 15 cm (%) (mm)				
LUNGHEZZA E LARGHEZZA: DEVIAZIONE AMMISSIBILE, IN %, DELLA DIMENSIONE MEDIA DI OGNI PIASTRELLA DALLA DIM. DI FABBRICAZIONE / LENGTH AND WIDTH: ADMITTED DEVIATION, IN %, OF THE AVERAGE SIZE OF EACH TILE FROM THE PRODUCTION / DIMENSIONS / LONGUEUR ET LARGEUR : MARGE DE TOLERANCE, EN %, ENTRE LA DIMENSION MOYENNE DE CHAQUE CARREAU ET LA DIM. DE FABRICATION / LANGE UND BREITE: ZULASSIGE ABWEICHUNG DES DURCHSCHNITTMASSES JEDER FLIESE VOM HERSTELLMAS IN PROZENTEN / DESVIACION ADMISIBILE, EN %, DEL TAMAÑO MEDIO DE CADA BALDOSA A PARTIR DEL TAMAÑO DE FABRICACIÓN.	Non squadrato EN 14411 - ISO 13006	±0,6%	±2,0mm	±0,6%	ISO 10545-2	
	Squadrato ISO 13006	±0,3%	±1,0mm	±0,15%		
DEVIAZIONE AMMISSIBILE, IN PERCENTO, DELLO SPESSORE MEDIO DI OGNI PIASTRELLA DALLA DIMENSIONE DI FABBRICAZIONE / ADMITTED DEVIATION, IN %, OF THE AVERAGE THICKNESS OF EACH TILE FROM THE PRODUCTION DIMENSIONS / MARGE DE TOLERANCE, EN POURCENTAGE, ENTRE L'ÉPAISSEUR MOYENNE DE CHAQUE CARREAU ET LA DIMENSION DE FABRICATION / ZULASSIGE ABWEICHUNG DER DURCHSCHNITTSDICKE JEDER FLIESE VOM HERSTELLMAS IN PROZENTEN / DESVIACION ADMISIBILE, EN TANTO POR CIENTO, DEL GROSOR MEDIO DE CADA BALDOSA A PARTIR DEL TAMAÑO DE FABRICACIÓN.	-	±5%	±0,5mm	±5%		
DEVIAZIONE MASSIMA DI RETTILINEARITÀ, IN PERCENTO, IN RAPPORTO ALLE DIMENSIONI DI FABBRICAZIONE CORRISPONDENTI / MAXIMUM STRAIGHTNESS DEVIATION, IN %, IN RELATION TO THE CORRESPONDING PRODUCTION DIMENSIONS / MARGE DE TOLERANCE DE RECTITUDE, EN POURCENTAGE, PAR RAPPORT AUX DIMENSIONS DE FABRICATION CORRESPONDANTES / ZULASSIGE HOCHSTABWEICHUNG DER KANTENGERADHEIT IM VERHÄLTNIS ZU DEN ENTSPRECHENDEN HERSTELLMÄßEN IN PROZENTEN / DESVIACION MÁXIMA DE RECTITUD, EN TANTO POR CIENTO, EN RELACIÓN CON EL TAMAÑO DE FABRICACIÓN CORRESPONDIENTE.	Non squadrato EN 14411 - ISO 13006	±0,5%	±1,5mm	±0,5%		
DEVIAZIONE MASSIMA DI ORTOGONALITÀ, IN PERCENTO, IN RAPPORTO ALLE DIMENSIONI DI FABBRICAZIONE CORRISPONDENTI / MAXIMUM RIGHT-ANGLE DEVIATION, IN %, IN RELATION TO THE CORRESPONDING PRODUCTION DIMENSIONS / MARGE DE TOLERANCE D'ANGULARITÉ, EN POURCENTAGE, PAR RAPPORT AUX DIMENSIONS DE FABRICATION / HOCHSTABWEICHUNG DER RECHTWINKLIGKEIT IM VERHÄLTNIS ZU DEN ENTSPRECHENDEN HERSTELLMÄßEN IN PROZENTEN / DESVIACION MÁXIMA DE LA ORTOGONALIDAD, EN TANTO POR CIENTO, EN RELACIÓN CON EL TAMAÑO DE FABRICACIÓN CORRESPONDIENTE.	Squadrato ISO 13006	±0,3%	±0,8mm	±0,10%		
	Non squadrato EN 14411 - ISO 13006	±0,5%	±2,0mm	±0,5%		
DEVIAZIONE MASSIMA DI ORTOGONALITÀ, IN PERCENTO, IN RAPPORTO ALLE DIMENSIONI DI FABBRICAZIONE CORRISPONDENTI / MAXIMUM RIGHT-ANGLE DEVIATION, IN %, IN RELATION TO THE CORRESPONDING PRODUCTION DIMENSIONS / MARGE DE TOLERANCE D'ANGULARITÉ, EN POURCENTAGE, PAR RAPPORT AUX DIMENSIONS DE FABRICATION / HOCHSTABWEICHUNG DER RECHTWINKLIGKEIT IM VERHÄLTNIS ZU DEN ENTSPRECHENDEN HERSTELLMÄßEN IN PROZENTEN / DESVIACION MÁXIMA DE LA ORTOGONALIDAD, EN TANTO POR CIENTO, EN RELACIÓN CON EL TAMAÑO DE FABRICACIÓN CORRESPONDIENTE.	Squadrato ISO 13006	±0,3%	±1,5mm	±0,20%		
	Non squadrato EN 14411 - ISO 13006	±0,5%	±2,0mm	±0,35%		
PLANARITÀ (CURVATURA DEL CENTRO, DELLO SPIGOLO E SVERGOLAMENTO) / FLATNESS (CURVING IN THE MIDDLE, CORNER AND WARPING) / PLANÉITÉ (COURBURE CENTRALE, DE L'ARÊTE ET GAUCHISSEMENT) / EBENFLÄCHIGKEIT (KRÜMMUNG DER MITTE, DER KANTE UND VERWINDUNG) / PLANITUD (CURVATURA DEL CENTRO, DE LA ARISTA Y ABARQUILLAMIENTO).	Squadrato ISO 13006	±0,4%	±1,8 mm	±0,35%		
	Non squadrato EN 14411 - ISO 13006	±0,5%	±2,0mm	±0,35%		
QUALITÀ DELLA SUPERFICIE - SURFACE QUALITY / QUALITÉ DE LA SURFACE - QUALITÄT DER OBERFLÄCHE / CALIDAD DE LA SUPERFICIE.	Il 95% min delle piastrelle deve essere esente da difetti visibili. / At least 95% of the tiles must be free from visible flaws. 95% min des carreaux ne doivent présenter aucun défaut visible. Mindestens 95% der Fliesen müssen frei von sichtbaren min. / el 95% de las baldosas tiene que estar exento de defectos visibles.		CONFORME/CONFORMING CONFORME/KONFORM CONFORME.			
 MASSA D'ACQUA ASSORBITA IN % / WATER ABSORPTION - MASSE D'EAU ABSORBÉE EN % / WASSERAUFNAHME IN % / MASA DE AGUA ABSORBIDA EN %	E≤0,5%		valore medio 0,08%			ISO 10545-3
 FORZA DI ROTTURA IN N (sp. ≥ 7,5 mm) - BREAKING STRENGTH IN N (thickness ≥ 7,5 mm) / FORCE DE RUPTURE EN N (ép. ≥ 7,5 mm) / BRUCHLAST IN N (Dicke ≥ 7,5 mm) / FUERZA DE ROTURA EN N (gr. ≥ 7,5 mm)	1300 min		valore medio 2200 N (spes.9mm) valore medio 14000 N (spes.20mm)		ISO 10545-4	
 RESISTENZA ALLA FLESSIONE IN N/mm2 / FLEXURAL STRENGTH TEST / RÉSISTANCE A LA FLEXION EN N/mm2 / BIEGEFESTIGKEIT IN N/mm / RESISTENCIA A LA FLEXION EN N/mm	35 min		valore medio 50 N/mm² (spes.9mm) valore medio 52 N/mm² (spes.20mm)		ISO 10545-4	
 RESISTENZA ALL'ABRASIONE PROFONDA DELLE PIASTRELLE NON SMALTATE / RESISTANCE TO DEEP ABRASION OF UNGLAZED TILES / RESISTANCE A L'ABRASION PROFONDE DES CARREAUX NON EMAILÉS / TIEFENABRIEFESTIGKEIT UNGLASIRTER FLIESEN / RESISTENCIA A LA ABRASION PROFUNDA DE LAS BALDOSAS SIN ESMALTAR	<175mm³		valore medio 140mm³		ISO 10545-6	
 RESISTENZA AGLI SBALZI TERMICI / THERMAL SHOCKS RESISTANT / RÉSISTANCE AUX VARIATIONS THERMIQUES TEMPERATUREWECHSELBESTÄNDIGKEIT / RESISTENCIA AL CHOQUE TÉRMICO.	-		RESISTE - RÉSISTANT RÉSISTE - ERFÜLLT RESISTE		ISO 10545-9	
 RESISTENZA ALLE MACCHIE / RESISTANCE TO STAINING / RÉSISTANCE AUX TACHES / FLECKENABWEISEND RESISTENCIA A LAS MANCHAS	-		≥ Classe 3		ISO 10545-14	
 RESISTENZA A BASSE CONCENTRAZIONI DI ACIDI E ALCALI. / RESISTANCE TO LOW CONCENTRATIONS OF ACIDS AND ALKALIS. / RESISTANCE A BASSES CONCENTRATIONS D'ACIDES ET ALCALIS. / WIDERSTAND GEGEN NIEDRIGE KONZENTRATIONEN VON SAUREN UND LAUGEN. / RESISTENCIA A BAJAS CONCENTRACIONES DE ACIDOS Y ALCALIS.	COME DICHIARATO DAL PRODUTTORE SEE MANUFACTURER'S DECLARATION SELON DÉCLARATION DU PRODUCTEUR ENTSPRECHEND DER HERSTELLERANGABEN TAL COMO DECLARA EL FABRICANTE		vedere la serie - see the collection voir la collection - siehe der kollektion ver la coleccion		ISO 10545-13	
	RESISTENZA A ALTE CONCENTRAZIONI DI ACIDI ED ALCALI / RESISTANCE TO HIGH CONCENTRATIONS OF ACIDS AND ALKALIS / RESISTANCE A HAUTES CONCENTRATIONS D'ACIDES ET BASES / BESTÄNDIGKEIT GEGEN STARK KONZENTRIERTE SAUREN UND LAUGEN / RESISTENCIA A ALTAS CONCENTRACIONES DE ÁCIDOS Y ALCALIS		vedere la serie - see the collection voir la collection - siehe der kollektion ver la coleccion			
	RESISTENZA AI PRODOTTI CHIMICI DI USO DOMESTICO E AGLI ADDITIVI PER PISCINA / RESISTENCE TO DOMESTIC CHEMICAL PRODUCTS AND ADDITIVES FOR SWIMMING POOLS / RÉSISTANT AUX PRODUITS CHIMIQUES À USAGE DOMESTIQUE ET AUX ADDITIFS POUR PISCINE / WIDERSTAND GEGEN HAUSHALTSCHIMIKALIEN UND SCHWIMMBADZUSATZSTOFFEN / RESISTENCIA A PRODUCTOS PARA LIMPIEZA DOMESTICA Y ADITIVOS PARA PISCINAS		UB min			UA
 RESISTENZA AL GELO / FROST RESISTANCE - RÉSISTANCE AU GEL / FROSTSICHERHEIT - RESISTENCIA A LA HELADA	-		RICHIESTA / REQUIRED REQUIRE / GEFORDET REQUERIDA		RESISTE - RÉSISTANT RÉSISTE - ERFÜLLT RESISTE	ISO 10545-12
 COEFFICIENTE D'ATTRITO (SCIVOLosità) / FRICTION COEFFICIENT (SLIPPERINESS) / COEFFICIENT DE FRICTION (GLISSEMENT) / REIBUNGSKOEFFIZIENT (SCHLUPFRIGKEIT) - COEFICIENTE DE ANTI DESLIZAMIENTO	-		-		vedere la serie - see the collection voir la collection - siehe der kollektion ver la coleccion	-

Per un effetto ottimale della posa, florm suggerisce di mantenere 2 mm di fuga per pose monoformato e 3 mm per combinare formati misti / For optimal installation results, florm recommends maintaining a joint of 2 mm 1/12" for single format installations and 3 mm 1/8" to combine mixed formats / Pour réaliser une pose parfaite, florm suggère de maintenir 2 mm de joint pour la pose des monoformats, et 3 mm pour les combinaisons de formats mixtes / Um einen optimalen effekt beim verlegen zu erzielen empfiehlt florm eine 2 mm fugge bei einformatigen verlegungen und 3 mm fugge bei formatkombinationen / Para lograr los máximos resultados en la posa del producto, florm aconseja 2 mm de junta en aplicaciones monoformato y 3 mm en combinaciones de formatos mixtos.

N.B.: Per informazioni relative ai dati tecnici su marcatura CE vedere il sito www.florm.com / Please refer to our web site www.florm.com for technical information related to CE labeling. / Pour tout renseignement sur l'avis technique de la marque CE veuillez consulter le site www.florm.com / Informationen bezüglich technischer Daten zur Beschriftung CE entnehmen Sie unserer Website www.florm.com / Para obtener más información y descargar las marcas CE: www.florm.com.
N.B.1: I ns. prodotti sono classificati secondo QB UPEC; vedi il sito www.florm.com / Our products are classified according to QB UPEC standards; visit the site www.florm.com / Nos produits sont classés selon les normes QB UPEC; voir le site www.florm.com / Unsere Produkte sind nach der Norm QB UPEC klassifiziert; siehe Webseite www.florm.com / Nuestros productos están clasificados según QB UPEC; consulte el sitio www.florm.com

CERTIFICAZIONI

CERTIFICATIONS

CERTIFICATIONS

ZERTIFIZIERUNGEN

CERTIFICACIONES

Certificazione di sistema / System certification / Certification de système / Systemzertifizierung / Certificación de sistema

La soddisfazione del Cliente, nel rispetto dell'Ambiente e della Sicurezza dei propri collaboratori, è la condizione essenziale per il successo della nostra azienda. Di conseguenza, Florim si impegna a porre come obiettivo prioritario il costante miglioramento dei propri prodotti e servizi. Florim Ceramiche S.p.A SB è la prima azienda nel settore a ottenere la certificazione del proprio Sistema di Gestione della Qualità, dell'Ambiente e della Salute e Sicurezza dei lavoratori e dell'Energia, in base alle norme **UNI EN ISO 9001, UNI EN ISO 14001, ISO 45001 e UNI EN ISO 50001**, relativamente a progettazione, produzione e vendita di piastrelle ceramiche in tutte le tipologie produttive.

Customer satisfaction, together with respect for the environment and for the safety of those who work with us are essential conditions for our company's success. As a result, Florim is committed to making the constant improvement of its products and services a priority. Florim Ceramiche S.p.A SB is the first company in the sector to obtain certification for its Quality Management System, its Environmental Management System and its Management System for the Health and Safety of workers and energy, according to **UNI EN ISO 9001, UNI EN ISO 14001, ISO 45001 and UNI EN ISO 50001** standards, relating to the design, manufacture and sales of ceramic tiles in all of its production types.

La satisfaction du client, dans le respect de l'environnement et de la sécurité de ses collaborateurs, est la condition essentielle au succès de notre entreprise. Florim s'engage donc à faire de l'amélioration constante de ses produits et services un objectif prioritaire. Florim Ceramiche S.p.A SB est la première entreprise du secteur à obtenir la certification de son système de gestion de la qualité, de l'environnement, de la santé et de la sécurité des employés et de l'énergie, conformément aux normes **UNI EN ISO 9001, UNI EN ISO 14001, ISO 45001 et UNI EN ISO 50001**, en matière de conception, production et vente de tous types de carreaux céramiques.

Die Zufriedenheit des Kunden unter Berücksichtigung von Umwelt und Sicherheit unserer Mitarbeiter ist die grundlegende Bedingung für den Erfolg unseres Unternehmens. Demzufolge setzt sich die Firma Florim dafür ein, die ständige Verbesserung ihrer Produkte und Dienstleistungen zum vorrangigen Ziel zu machen. Die Firma Florim Ceramiche S.p.A SB ist das erste Unternehmen in diesem Fachbereich, das die Zertifizierung seines Managementsystems der Qualität, Umwelt und Gesundheit und Sicherheit, und energie auf Grund der Bestimmungen **UNI EN ISO 9001, UNI EN ISO 14001, ISO 45001 und UNI EN ISO 50001**, in Bezug auf Entwurf, Produktion und Verkauf von Keramikfliesen in allen Herstellungsarten erhielt.

La satisfacción del Cliente, con un respeto total del ambiente y seguridad de sus colaboradores, representa la condición esencial para el éxito de nuestra empresa. Por ello, Florim se compromete a perseguir, como objetivo prioritario, una mejora constante de sus productos y servicios. Florim Ceramiche S.p.A SB es la primera empresa en el sector que ha obtenido el certificado del Sistema de Gestión de la Calidad, Ambiente, Salud y Seguridad de los trabajadores y energía en base a la normativa **UNI EN ISO 9001, UNI EN ISO 14001, BS OHSAS 18001 y UNI EN ISO 50001**, en relación al proyecto, producción y venta de baldosas de cerámica en todas las tipologías productivas.



Certificazioni ambientali di prodotto / Product environmental certifications / Certifications environnementales des produits

Produktzertifizierungen im zeichen des umweltschutzes / Certificaciones ambientales de producto



GREENGUARD

Certification is the very first voluntary North American indoor air quality product certification created specifically for commercial building products, this certification requires that products meet stringent chemical emissions requirements for over 360 VOCs, plus a limit on the total of all chemical emissions combined. Products undergo routine monitoring and annual retesting to ensure continued compliance with the **GREENGUARD** Certification standard.



GREENGUARD GOLD

Certification was developed with the specific health sensitivities of children and other vulnerable health populations in mind and based on key criteria from public health agencies, this certification sets some of the world's most stringent emission limits on over 360 chemicals, a limit on total chemical emissions, and a limit on phthalate emissions. Products undergo routine monitoring and annual retesting to ensure continued compliance with the **GREENGUARD Gold** standard.

GREENGUARD / GREENGUARD GOLD

Per ulteriori informazioni e approfondimenti / For further details and information / Pour approfondir et obtenir de plus amples informations

Für weitere Informationen / Para obtener más información



BUREAU VERITAS

Bureau Veritas è il marchio che certifica la natura riciclata del materiale di cui è composto un prodotto, sottoponendo a verifica l'intero ciclo produttivo. Viene controllata e documentata la provenienza dei materiali di riciclo, il loro dosaggio, il rispetto di alcune peculiarità tecnologiche e il raggiungimento dei parametri stabiliti della norma ISO14021:2002 dell'International Organization for Standardization e del regolamento LEED 2.2 NC del U.S. Green Building Council (USGBC).
Per maggiori informazioni: www.bureauveritas.com

Bureau Veritas is the mark that certifies the recycling of the material that goes into the making of a product, by running an inspection on the entire production cycle. Checks and documentation are carried out on the provenance of the recycled material, the quantities used, the observance of certain technological particulars and the achievement of the parameters established by the ISO14021:2002 regulations of the International Organization for Standardization and the LEED 2.2 NC regulation of the U.S. Green Building Council (USGBC). For more information: www.bureauveritas.com

Bureau Veritas est une marque qui certifie que le matériau dont un produit est composé a été recyclé, en soumettant l'ensemble du cycle de production à une vérification. La provenance des matériaux recyclés est contrôlée et prouvée, de même que leur dosage et le respect de certaines caractéristiques technologiques et des paramètres définis par la norme ISO14021:2002 de l'Organisation internationale de normalisation et le règlement LEED 2.2 NC de l'U.S. Green Building Council (USGBC).
Pour plus d'informations : www.bureauveritas.com

Bureau Veritas ist ein Markenzeichen, das die rezyklierte Art des Materials zertifiziert, aus dem ein Produkt besteht und dazu den gesamten Produktionszyklus prüft. Kontrolliert und beurkundet wird die Herkunft der rezyklierten Materialien, deren Dosierung, die Einhaltung einiger technologischer Eigenschaften und das Erreichen der Parameter, die von den Vorschriften ISO14021:2002 der International Organization for Standardization und von den LEED-Vorschriften 2.2 NC des U.S. Green Building Council (USGBC) vorgeschrieben werden.
Für weitere Infos siehe: www.bureauveritas.com

Bureau Veritas es la marca que certifica la naturaleza reciclada del material con el que está hecho un producto, sometiendo a control todo el ciclo productivo. Se controla y documenta la proveniencia de los materiales reciclados, su dosificación, que se respeten algunas peculiaridades tecnológicas y que se alcancen los parámetros establecidos por la norma ISO14021:2002 de la International Organization for Standardization y del reglamento LEED 2.2 NC del U.S. Green Building Council (USGBC).
Para más información: www.bureauveritas.com

Florim e l'ambiente

Florim and the environment / Florim et l'environnement / Florim und die umwelt / Florim y el ambiente



ENVIRONMENT PRIORITY ONE / Using nature's resources responsibly

Per sottolineare l'attenzione e l'impegno verso la tutela dell'ambiente, in accordo con la norma ISO 14021 (Environmental labels and declarations) Florim afferma il proprio impegno nella continua innovazione tecnologica dei processi industriali.

To underline our care for the environment and our pledge to protect it in accordance with the ISO 14021 standards (Environmental labels and declarations), Florim affirms its commitment to continual technological innovation of the industrial processes in order.

Pour prouver l'attention qu'elle consacre depuis toujours à la protection de l'environnement, en accord avec la norme ISO 14021 (Environmental labels and declarations), la société Florim déclare son engagement dans l'innovation technologique continue des processus industriels.

Die Firma Florim möchte ihre Aufmerksamkeit und ihr Engagement zum Schutz der Umwelt gemäß der ISO-Norm 14021 (Environmental labels and declarations) hervorheben und bekräftigt deshalb, dass sie ständig auf technologische Innovation der Industrieprozesse.

Para subrayar la atención y el compromiso adquirido con la tutela del medio ambiente, de acuerdo con la norma ISO 14021 (Environmental labels and declarations) Florim reafirma su dedicación por la continua innovación tecnológica de los procesos industriales.

Certificati di prova / Test certificates / Certifications de produit / Produktzertifizierungen / Certificaciones de producto



I certificati di prova sono disponibili direttamente sui siti Internet dei vari brand, nella sezione Prove Tecniche dedicata alle diverse collezioni.
Per ulteriori informazioni e approfondimenti: www.florim.com

The test certificates are available directly on the websites of the various brands, in the Technical Test section dedicated to the different collections.
For further details and information: www.florim.com

Les certificats de test de performance sont disponibles directement sur les sites Internet des différentes marques, dans la section Essais Techniques consacrée aux différentes collections. Pour approfondir et obtenir de plus amples informations: www.florim.com

Die Prüfbescheinigungen sind direkt auf den Internetseiten der entsprechenden Brands im Bereich Technische Prüfungen der verschiedenen Kollektionen verfügbar. Für weitere Informationen: www.florim.com

Los certificados de ensayo están disponibles directamente en los sitios internet de las diferentes marcas, en la sección Ensayos Técnicos dedicada a las diferentes colecciones. Para obtener más información: www.florim.com

Marcatura CE / CE Mark / Marquage CE / CE-Kennzeichnung / Marca CE



Per ulteriori informazioni, approfondimenti e download delle marcature CE: www.florim.com

For further details and information and to download the CE marks: www.florim.com

Pour obtenir de plus amples informations, approfondir et télécharger les marquages CE: www.florim.com

Für weitere Informationen und Downloads der CE-Kennzeichnungen: www.florim.com

Para obtener más información y descargar las marcas CE: www.florim.com

Certificazioni di prodotto nazionali / National product certifications / Certifications de produit nationaux
Nationale Produktzertifizierungen Certificaciones de producto nacionales



放射性水平 A类

Certificazione obbligatoria per l'esportazione in Cina
Certification mandatory for export to China
Certification obligatoire pour l'exportation en Chine
Für den Export nach China obligatorische Zertifizierung
Certificación obligatoria para la exportación a China

Per soddisfare le richieste di norme e regolamenti locali, vi sono anche diverse certificazioni di prodotto nazionali.
Per informazioni in merito contattare www.florim.com

To cater for the requirements of local norms and regulations, various national product certifications also exist. For more details contact www.florim.com

Pour satisfaire les exigences des normes et réglementations locales, il existe également différentes certifications nationales de produit.

Pour de plus amples informations à ce sujet contacter www.florim.com

Darüber hinaus sind auch verschiedene nationale Produktzertifizierungen vorhanden, um die lokalen Anforderungen bezüglich Richtlinien und Reglementen zu erfüllen. Für Informationen dazu wenden Sie sich bitte an www.florim.com

Para satisfacer los requisitos previstos por las normas y reglamentos locales, hay también varias certificaciones de producto nacionales. Para obtener más información, contacte con www.florim.com



UPEC

QB-UPEC

Per informazioni relative ai dati tecnici sulla classificazione UPEC vedi il sito www.florim.com
Pour toute information concernant les données techniques sur la classification UPEC, nous vous prions de bien vouloir consulter la version française du site www.florim.com



WallIPEC

QB-WallIPEC

Per informazioni relative ai dati tecnici sulla classificazione WallIPEC vedi il sito www.florim.com
Pour toute information concernant les données techniques sur la classification WallIPEC, nous vous prions de bien vouloir consulter la version française du site www.florim.com

U.S. GREEN BUILDING COUNCIL



Florim ha aderito volontariamente all'U.S. Green Building Council (USGBC), la più importante associazione statunitense di industrie appartenenti al settore edilizio, unite per promuovere edifici costruiti in accordo a precise disposizioni riguardanti la sostenibilità ambientale che sono incluse all'interno della certificazione LEED (Leadership in Energy and Environmental Design), un sistema a punteggio che misura la sostenibilità di un progetto. L'utilizzo di prodotti Florim contribuisce a ottenere punti per l'acquisizione della certificazione LEED.

Florim has voluntarily become a member of the U.S. Green Building Council (USGBC), the most important American association dedicated to environmentally sustainable building design and construction according to precise directives, which must be followed in order to obtain LEED (Leadership in Energy and Environmental Design) certification, a rating system that measures the sustainability of a project. Using Florim products contributes to getting points to achieve LEED certification.

Florim a adhéré volontairement à l'U.S. Green Building Council (USGBC), la plus grande association américaine d'industries appartenant à la filière BTP, unies pour promouvoir la réalisation de constructions conformes aux dispositions précises édictées en matière de durabilité environnementale, incluses dans la certification LEED (Leadership in Energy and Environmental Design), un système d'attribution de notes mesurant la durabilité d'un projet. L'utilisation des produits Florim contribue à l'obtention de points en vue de la certification LEED.

Florim ist freiwillig dem U.S. Green Building Council (USGBC) beigetreten, dem bedeutendsten Verband der Bauindustrien in den Vereinigten Staaten, die sich zur Förderung von Gebäuden vereinigt haben, die gewissen Nachhaltigkeitsvorschriften entsprechend gebaut werden. Diese Bestimmungen sind in der LEED-Zertifizierung (Leadership in Energy and Environmental Design), einem Punktesystem zur Bewertung der Nachhaltigkeit eines Projekts, enthalten. Der Gebrauch von Florim Produkten trägt zur Erlangung von Punkten der LEED-Zertifizierung bei.

Florim ha adherido voluntariamente al U.S. Green Building Council (USGBC), la más importante asociación estadounidense de industrias pertenecientes al sector de la construcción, unidas para promover la construcción de edificios de acuerdo con precisas disposiciones relativas a la sostenibilidad ambiental, que están incluidas en la certificación LEED (Leadership in Energy and Environmental Design), un sistema por puntos que mide la sostenibilidad de un proyecto. El uso de productos Florim contribuye a obtener puntos para adquirir la certificación LEED.

La certificazione LEED è una certificazione di edificio non di prodotto. Pertanto i criteri LEED fanno sempre riferimento al sistema edificio e non ai singoli materiali utilizzati nel progetto. La soglia indicata nei crediti si riferisce quindi al parametro cui l'edificio dovrà conformarsi per l'attribuzione del relativo punteggio. Sul sito Florim.com, All'interno delle certificazioni di ogni singola collezione, è disponibile la Certification Letters for LEED® Projects.

LEED certification is a building certification and not for a product. Therefore, the LEED criteria always refer to the building system and not to the individual building materials used in the project. The threshold indicated in the credits, therefore refers to the parameter to which the building must comply with for the allocation of the corresponding point score. Certification Letters for LEED® Projects are available on the Florim.com website, in the certifications for each single collection.

La certification LEED (« Leadership in Energy and Environmental Design ») est une certification qui concerne les bâtiments et non pas les produits. Ainsi, les critères LEED font toujours référence au système bâtiment et non pas aux matériaux utilisés dans le projet. Le seuil indiqué dans les crédits se réfère donc au paramètre auquel le bâtiment devra se conformer pour l'attribution des points correspondants. Sur le site Florim.com, parmi les certifications de chaque collection, la Certification Letters for LEED® Projects est disponible.

Bei der LEED-Zertifizierung handelt es sich nicht um ein Produkt- sondern ein Gebäudezertifizierungssystem. Daher beziehen sich die LEED-Kriterien immer auf das Gebäude im Ganzen, nicht auf die einzelnen für das Projekt verwendeten Materialien. Der für die Punkte angegebene Grenzwert bezieht sich daher auf den Wert, den das Gebäude einhalten muss, um die entsprechenden Punkte zu erhalten. Auf der Website Florim.com finden sich in den Zertifizierungen der einzelnen Kollektionen die Certification Letters for LEED® Projects.

La certificación LEED es una certificación para el edificio y no para el producto. Por lo tanto los criterios LEED siempre se refieren al sistema edificio y no a cada uno de los materiales utilizados en el proyecto. El umbral indicado en los créditos se refiere por lo tanto al parámetro al cual el edificio se deberá ajustar para que le sea atribuida la correspondiente puntuación. En el sitio web Florim.com, en la sección de las certificaciones de cada colección, están disponibles las Certification Letters for LEED® Projects.



ENVIRONMENTAL PRODUCT DECLARATION

L'EPD è una Dichiarazione Ambientale di Prodotto certificata e verificata in modo indipendente, che esprime in modo trasparente e oggettivo le prestazioni ambientali di un prodotto lungo il suo ciclo di vita, in accordo con lo Standard internazionale ISO 14025. L'EPD è basata su specifiche regole che ne definiscono le metodologie di calcolo: le Product Category Rules (PCR), e non prevede soglie prestazioni.

The EPD is a certified and independently verified Environmental Product Declaration that expresses in a transparent and objective manner the environmental performance of a product throughout its life cycle, in accordance with the International Standard ISO 14025. The EPD is based on specific rules that define the calculation methodologies: the Product Category Rules (PCR), and does not provide for performance thresholds.

La DEP est une Déclaration Environnementale de Produit certifiée et vérifiée de façon indépendante, décrivant de manière transparente et objective les performances environnementales d'un produit tout au long de son cycle de vie, conformément à la norme internationale ISO 14025. La DEP s'appuie sur des règles spécifiques qui définissent ses méthodes de calcul : les Product Category Rules (PCR), et ne prévoit pas de seuils de performance.

EPD ist eine zertifizierte und unabhängig kontrollierte Produkt-Umwelterklärung, die, übereinstimmend mit der internationalen Norm ISO 14025, auf transparente und objektive Weise die Umweltleistungen eines Produkts während seines Lebenszyklus bekundet. EPD basiert auf spezifischen Regeln, die die Berechnungsmethode festlegen: die Product Category Rules (PCR), die keine Leistungsschwellen vorsehen.

La DAP es una declaración ambiental de producto, certificada y verificada de manera independiente, que informa acerca del desempeño ambiental de un producto a lo largo de su ciclo de vida de forma transparente y objetiva, de conformidad con la norma internacional ISO 14025. La DAP se basa en reglas específicas que definen sus métodos de cálculo, denominadas Reglas de categoría de producto (RCP), y no prevé umbrales de desempeño.

CONDIZIONI GENERALI DI VENDITA

GENERAL CONDITIONS OF SALE
CONDITIONS GÉNÉRALES DE VENTE
ALLGEMEINE GESCHÄFTSBEDINGUNGEN
CONDICIONES GENERALES DE VENTA

CONDIZIONI GENERALI DI VENDITA

1 NORMATIVA CONTRATTUALE

Le presenti condizioni generali, salvo modificazioni o deroghe concordate per iscritto, disciplinano tutti i contratti di vendita fra Florim Ceramiche S.p.A. SB e l'Acquirente senza che sia necessario un espresso richiamo a esse. Le variazioni delle condizioni generali di vendita, le offerte, gli accordi o gli abbuoni accordati dai nostri agenti o altri intermediari, non sono validi se non accettate per iscritto dalla nostra sede.

2 OGGETTO DELLA FORNITURA

La fornitura comprende solamente i materiali, le prestazioni ed i quantitativi specificati nella nostra conferma d'ordine. Il testo della conferma d'ordine Florim Ceramiche S.p.A. SB prevarrà in ogni caso sul testo difforme della eventuale offerta o della ordinazione.

3 CONFERMA D'ORDINE

Qualora nella conferma d'ordine Florim Ceramiche S.p.A. SB esistano differenze nei singoli elementi che la compongono rispetto alle intese od alle ordinazioni, l'Acquirente che non abbia contestato per iscritto entro 7gg dalla ricezione della nostra conferma s'intende che l'abbia accettata così come è stata redatta. Il cliente si impegna a comunicare a Florim Ceramiche S.p.A. SB l'eventuale variazione del luogo di destinazione della merce, se diverso da quello citato nella conferma d'ordine, entro e non oltre il giorno previsto per il ritiro presso Florim Ceramiche S.p.A. SB, mediante invio, tramite posta e-mail, dei dati identificativi del destinatario delle merci e del luogo presso il quale dovrà essere effettuata la consegna. In mancanza di tale comunicazione la destinazione originariamente indicata si intende tacitamente confermata.

4 PREZZI

I prezzi indicati sui listini Florim Ceramiche S.p.A. SB non sono impegnativi: di conseguenza ci riserviamo il diritto di modificarli prima dell'accettazione dell'ordine. I prezzi pattuiti per ogni singola vendita si intendono al netto, per contanti per consegna franco stabilimento, salvo diversa pattuizione scritta. Se fra la data di ordinazione (anche dopo la conferma d'ordine) e quella di consegna si verificassero aumenti nei costi delle materie prime, della manodopera, dei combustibili, nelle spese di produzione, di trasporto ecc., e in caso di variazione rilevante dei tassi di cambio tra divisa di fatturazione e divisa interna, Florim Ceramiche S.p.A. SB potrà aumentare il prezzo convenuto dandone comunicazione scritta all'Acquirente anche a mezzo posta elettronica. Tuttavia, qualora detto prezzo superi del 20% quello convenuto al momento dell'ordinazione, l'Acquirente potrà recedere dal contratto notificandoci per raccomandata tale sua volontà entro il termine perentorio di 10 gg dal ricevimento dell'avviso dell'aumento di prezzo. In difetto, il nuovo prezzo s'intenderà accettato.

5 CONSEGNE

La vendita, salvo diversa pattuizione scritta, è sempre franco stabilimento di Florim Ceramiche S.p.A. SB. La merce viaggia a rischio e pericolo dell'Acquirente ed ogni nostra responsabilità cessa con la consegna al vettore, nei confronti del quale l'Acquirente, effettuate le opportune verifiche, dovrà sporgere eventuali reclami. Le spedizioni, via mare o via terra, concernenti forniture sull'estero, vengono effettuate in base alle condizioni scelte di volta in volta, riportate negli "Incoterms" approvati dalla Camera di Commercio Internazionale.

6 TERMINI DI CONSEGNA

I termini di consegna hanno carattere indicativo: eventuali ritardi nelle consegne, interruzioni, sospensioni totali o parziali delle forniture non daranno diritto ad indennizzi o risarcimento danni se non diversamente concordato per iscritto.

7 CAMPIONI

I dati figuranti nei documenti illustrativi di Florim Ceramiche S.p.A. SB, così come le caratteristiche dei campioni e i modelli da quest'ultimo inviati all'Acquirente, hanno carattere di indicazioni approssimative. Questi dati non hanno valore impegnativo se non nella misura in cui siano stati espressamente menzionati come tali nell'offerta o nell'accettazione scritta di Florim Ceramiche S.p.A. SB.

8 PAGAMENTI

Le fatture di Florim Ceramiche S.p.A. SB possono essere emesse il giorno della fornitura, a cadenza quindicinale o mensile e devono essere pagate al netto alla scadenza pattuita. Ogni e qualsiasi obbligazione di pagamento tra le parti contraenti deve essere adempiuta presso la sede della Florim Ceramiche S.p.A. SB. Eventuali pagamenti fatti ad agenti, rappresentanti o ausiliari di commercio di Florim Ceramiche S.p.A. SB non si intendono effettuati finché le relative somme non pervengano a Florim Ceramiche S.p.A. SB. Il pagamento dovrà essere effettuato, salvo diverso accordo scritto, contestualmente alla consegna, presso l'istituto bancario indicato di Florim Ceramiche S.p.A. SB. Qualsiasi ritardo o irregolarità nel pagamento dà a Florim Ceramiche S.p.A. SB il diritto di sospendere le forniture o di risolvere i contratti in corso, anche se non relativi al pagamento in questione, nonché il diritto al risarcimento degli eventuali danni. Florim Ceramiche S.p.A. SB ha comunque diritto – a decorrere dalla scadenza del pagamento, senza necessità di messa in mora – agli interessi moratori sulla misura prevista dal d.lgs. 09/10/2002 n. 231. In caso d' inadempimento, anche solo parziale, gli interessi moratori sull'importo non pagato decorrono dal giorno della consegna anche se il termine di pagamento era stato convenuto a data successiva. Nessuna contestazione o controversia inerente alla qualità della merce, a vizi o difetti, o a qualsiasi altro aspetto del contratto, sarà efficace e potrà essere presa in considerazione, e così pure nessuna azione potrà essere iniziata se non dopo l'avvenuto integrale pagamento del prezzo (clausola solve et repute). Non è ammessa compensazione con eventuali crediti, comunque insorti, nei confronti di Florim Ceramiche S.p.A. SB.

9 GARANZIE E RECLAMI

La qualità del materiale ceramico è definita sulla base delle vigenti normative internazionali applicabili alla corrispondente classe di prodotto. Florim Ceramiche S.p.A. SB garantisce la sola merce fornita in prima scelta. Reclami relativi a merce in scelta differente dalla prima (scelta B, commerciale, seconda, terza, secondaria, stock, etc.) non saranno presi in considerazione, né viene data implicitamente od esplicitamente alcun tipo di garanzia su tali materiali. È fatto obbligo all'Acquirente di verificare la merce in termini di qualità e quantità entro breve tempo dal ricevimento in caso di reclamo (viaggi, perizie, ecc.). L'obbligo di Florim Ceramiche S.p.A. SB è, in ogni caso, limitato alla sostituzione dei soli pezzi difettosi o alla riparazione, con esplicita esclusione di ulteriori diversi indennizzi quali, a titolo indicativo ma non limitativo, per costi di rimozione e sistemazione di mobili, attrezzature, macchinari ecc., mancanti guadagni per interruzione o sospensione di attività, disagi, danni indiretti ecc.. La presenza di piastrelle difettose non inficia la qualità dell'intera fornitura né comporta l'obbligo della integrale sostituzione. I limiti temporali della durata della garanzia sono quelli stabiliti dal codice civile italiano.

10 RISERVATO DOMINIO

La vendita della merce viene effettuata con la clausola del riservato dominio; pertanto, nel caso in cui il pagamento, per accordi contrattuali, debba essere effettuato tutto o in parte dopo la consegna, i prodotti consegnati restano di proprietà Florim Ceramiche S.p.A. SB fino all'integrale pagamento del prezzo.

11 CESSIONE DEL CONTRATTO

L'Acquirente non può cedere la sua posizione nel contratto od in singoli rapporti obbligatori da questo derivanti senza l'accettazione scritta di Florim Ceramiche S.p.A. SB: anche in tal caso l'Acquirente rimane comunque solidalmente responsabile col cessionario per le obbligazioni cedute.

12 PROPRIETA' INDUSTRIALE E DISTRIBUZIONE SELETTIVA - LIMITI ALLA RIVENDITA

Florim Ceramiche S.p.A. SB è titolare e legittimo detentore di esclusive relative ai marchi, a disegni e brevetti di invenzione. Al fine di garantire al meglio il rispetto dei diritti esclusivi di Florim Ceramiche S.p.A. SB, nonché le aspettative dei consumatori finali in ordine alle caratteristiche qualitative attese, Florim Ceramiche S.p.A. SB gestisce le forniture dei propri prodotti mediante un sistema di distribuzione selettiva. Le forniture ricevute da Florim Ceramiche S.p.A. SB e dai propri punti vendita selettivi autorizzati sono destinate all'installazione presso l'utente finale e non è consentita altra forma di rivendita a ulteriori intermediari commerciali diversi dagli utenti finali, salvo previa autorizzazione scritta da parte di Florim Ceramiche S.p.A. SB. La rivendita della merce in violazione di tale divieto deve considerarsi pertanto non consentita ed equiparata ad uso illecito dei diritti di proprietà industriale e intellettuale di Florim Ceramiche S.p.A. SB, con diritto di Florim Ceramiche S.p.A. SB di chiederne il sequestro presso qualunque detentore. Florim Ceramiche S.p.A. SB si riserva il diritto di procedere giudizialmente nei confronti di chiunque sia coinvolto in rivendite non autorizzate.

13 LEGGE DEL CONTRATTO - FORO COMPETENTE

Il contratto è disciplinato dalla legge italiana, competendo gli Usi di settore della Provincia di Modena. Per qualsiasi controversia comunque derivante dal contratto di fornitura, tanto da parte di Florim Ceramiche S.p.A. SB come da parte dell'Acquirente, è esclusivamente competente il Tribunale di Modena. E comunque in facoltà di Florim Ceramiche S.p.A. SB adire forti concorrenti o alternativi.

14 SICUREZZA DELLA CATENA LOGISTICA

Florim Ceramiche S.p.A. SB al fine di garantire la sicurezza della catena logistica internazionale richiede ai propri CLIENTI il rispetto di requisiti standard per garantire la sicurezza delle merci nei rapporti contrattuali e per garantire la loro conformità alla normativa AEO - Operatore Economico Autorizzato - Dogane, in tutta la Comunità Europea. I CLIENTI di Florim Ceramiche S.p.A. SB si impegnano a garantire che le merci prese in consegna o consegnate siano spedite o trasportate, immagazzinate, preparate e caricate in locali sicuri e in zone di carico e di spedizione sicure, protette contro manomissioni non autorizzate, utilizzando solo personale interno autorizzato ed opportunamente istruito.

Tutti gli articoli di questo listino sono venduti esclusivamente a scatole complete.

IL PRESENTE LISTINO ANNULLA E SOSTITUISCE I PRECEDENTI

GENERAL CONDITIONS OF SALE

1 CONTRACTUAL REGULATIONS

These general conditions, subject to modifications or waivers agreed in writing, govern all sales contracts between Florim Ceramiche S.p.A. SB and the Purchaser without the need for an express reference to them. Variations in the general conditions of sale, offers, credits or allowances agreed by our agents or other intermediaries, are not valid unless accepted in writing by our head office.

2 SUBJECT OF THE SUPPLY

The supply includes only the materials, services and quantities specified in our order confirmation. The text of the Florim Ceramiche S.p.A. SB order confirmation shall prevail in any case over any differing text of the offer or order.

3 ORDER CONFIRMATION

If, in the Florim Ceramiche S.p.A. SB order confirmation, there are differences in the individual elements comprising it, compared with the agreements or the orders, the Purchaser is understood to have accepted our confirmation as it was drawn up, unless an objection to it is made in writing within 7 days of receipt of it. The customer undertakes to notify Florim Ceramiche S.p.A. SB of the place of destination of the goods, if different from the address quoted on the order confirmation. In the case of any variation in the place of destination, the identification data of the destination address for the goods and the place where delivery is to be made must be sent by post or email, before the day laid down for collection at Florim Ceramiche S.p.A. SB's premises. If no notification is received, the destination originally shown shall be understood as tacitly confirmed.

4 PRICES

The prices shown in the Florim Ceramiche S.p.A. SB price-lists are not binding; we therefore reserve the right to modify them before acceptance of the order. The prices agreed upon for each individual sale are understood as net, for cash and for delivery ex-works, subject to any different written stipulation. If there should be increases in costs of raw materials, labour, fuel, production or transport costs, etc. and in the event of a significant change in the exchange rates between the billing currency and the local currency, between the order date (even after the order confirmation) and the delivery date, Florim Ceramiche S.p.A. SB may increase the agreed price, giving written notification to the Purchaser also by email. However, if this price should exceed the price agreed at the time of order by 20%, the Purchaser may withdraw from the contract by notifying us by registered letter of his desire to do so within the deadline of 10 days from receipt of the notice of price increase. If he fails to do so, the price shall be understood as accepted.

5 SHIPMENTS

The sale is always ex-works at the Florim Ceramiche S.p.A. SB premises, unless otherwise agreed in writing. The goods travel at the Purchaser's risk and our liability ends with delivery to the carrier, to whom the Purchaser after performing suitable checks must make any claims that may arise. Shipments by sea or land concerning supplies carried out abroad are performed according to conditions chosen on a time-by-time basis, shown in the "Incoterms" approved by the International Chamber of Commerce.

6 DELIVERY TIMES

Delivery times are by way of indication only; any delays in delivery and interruptions and total or partial suspensions of supplies shall not give rise to an entitlement to refunds or claims for compensation unless otherwise agreed in writing.

7 SAMPLES

The data shown in the Florim Ceramiche S.p.A. SB illustrative documents, as well as the characteristics of samples and models sent by Florim Ceramiche S.p.A. SB to the Purchaser, is of an approximately indicative nature. This data has no binding value except to the extent to which they were expressly mentioned as such in Florim Ceramiche S.p.A. SB's offer or written acceptance.

8 PAYMENTS

Florim Ceramiche S.p.A. SB's invoices can be issued on the day of supply, fortnightly or monthly and must be paid net on the agreed expiry date. Each and every obligation for payment between the contracting parties must be performed at Florim Ceramiche S.p.A. SB's head office. Any payments made to agents, sales representatives or assistants of Florim Ceramiche S.p.A. SB are not considered to have been carried out until the relative sums have reached Florim Ceramiche S.p.A. SB. Payment must be carried out, subject to any other written agreement, at the same time as the delivery; to the bank indicated by Florim Ceramiche S.p.A. SB. Any delay or irregularity in payment gives Florim Ceramiche S.p.A. SB the right to suspend supplies or to terminate current contracts, even if they do not relate to the payments in question, as well as the right to claim any damages. Florim Ceramiche S.p.A. SB is in any case entitled – starting from the payment expiry date, and without the need for notice of default – to the interest on arrears to the extent provided for by Italian Legislative Decree No. 231 of 09/10/2002. In the case of non-fulfilment, even only partial, the interest on arrears for the unpaid amount shall start from the day of delivery even if the payment term was agreed on as a later date. No objection or dispute referring to the quality of the goods or to flaws or defects or to any other aspect of the contract shall be valid and can be taken into consideration; in addition, no action may be started up until after payment has been made of the entire amount of the price (solve et repute clause). Compensation to Florim Ceramiche S.p.A. SB, with any credits, however they may have arisen, is not permitted.

9 GUARANTEES AND COMPLAINTS

The quality of the ceramic material is defined on the basis of the prevailing international regulations applicable to the corresponding product class. Florim Ceramiche S.p.A. SB guarantees only goods supplied as prime quality. Complaints relating to goods other than of prime quality ("B" quality, commercial, second, third, secondary, stock, etc.) shall not be taken into consideration, nor will any kind of guarantee be given, either implicitly or explicitly, on these materials. The Purchaser is obliged to check the goods in terms of quality and quantity within a short time after receipt and, in the case of a complaint, to give notification of this in writing no later than 8 (eight) days from receipt of the goods; failure to do so will incur the forfeiture of all rights. Material deemed to be defective must be held at Florim Ceramiche S.p.A. SB's disposal for the checks that it will consider suitable to carry out; any further action (return, repair or other) must be authorized in advance by us in writing. Complaints and requests for intervention under guarantee after the material has been laid shall not be taken into account if the defect reported is evident (e.g. chips, defects of size, differences in colour shade, etc.) it is made clear that the prime quality may contain defective tiles up to a limit of 5% and that the colour shades of the material supplied may differ from the sample displayed, since ceramic is intrinsically variable in appearance. Complaints attributed to latent flaws or defects must be formalized in writing within 8 (eight) days from their discovery and, in any case, within one year from delivery; failure to do so will incur the forfeiture of all rights under the guarantee and to compensation. As well as the invoice details, the notification must contain a precise description of the defect and an estimate of costs for repair or modification of the product; failure to notify this data will cause the complaint to be deemed invalid. If the complaint should prove to be unfounded the Purchaser must reimburse Florim Ceramiche S.p.A. SB for all the expenses incurred for assessment (travelling expenses, surveys, etc.). Florim Ceramiche S.p.A. SB's obligation is, in any case, limited to replacing the defective pieces only or to repairing them, with the express exclusion of other, further indemnities such as, by way of a non-limiting example, forecasts of removing and re-installing furniture, equipment, machinery, etc., or loss of earnings for interruption or suspension of business, inconvenience, consequential damages, etc. The presence of defective tiles does not invalidate the quality of the entire supply, nor does it incur the obligation for its entire replacement. The time limits for the duration of the guarantee are as established by the Italian Civil Code.

10 RETENTION OF TITLE

Sale of the goods is carried out with the retention of title clause; therefore if payment, by contractual agreements, must be carried out wholly or in part after delivery, the products delivered remain the property of Florim Ceramiche S.p.A. SB until the entire price has been paid.

11 TRANSFER OF CONTRACT

The Purchaser may not transfer his position in the contract or in individual binding agreements deriving from this without Florim Ceramiche S.p.A. SB's written acceptance: also in this case the Purchaser anyway remains jointly liable with the transferee for the obligations transferred.

12 INDUSTRIAL PROPERTY AND SELECTIVE DISTRIBUTION - LIMITS ON RESALE

Florim Ceramiche S.p.A. SB is the owner and legal holder of the exclusive rights to brand names, designs and patents. In order to guarantee full respect for Florim Ceramiche S.p.A. SB's exclusive rights, as well as the end consumers' expectations with regard to expected quality characteristics, Florim Ceramiche S.p.A. SB manages the supplies of its products by means of a selective distribution system. Supplies received from Florim Ceramiche S.p.A. SB and from its authorized selective sales outlets are designed for installation at the end user's premises and no other form of resale to further sales agents other than the end users is permitted, unless with Florim Ceramiche S.p.A. SB's prior written authorization. Goods that are re-sold in breach of this provision must therefore be considered as not permitted and treated as an unlawful use of Florim Ceramiche S.p.A. SB's industrial and intellectual property rights, with Florim Ceramiche S.p.A. SB's right to ask for them to be seized at the premises of any holder. Florim Ceramiche S.p.A. SB reserves the right to take legal proceedings against anyone who is involved in unauthorized re-selling.

13 LAW GOVERNING THE CONTRACT - PLACE OF JURISDICTION

The contract is governed by Italian law, including the customs of the sector in Modena Province. For any dispute that may in any case derive from the supply contract, either on the part of Florim Ceramiche S.p.A. SB or on the part of the Purchaser, the Modena Court has exclusive competence. Florim Ceramiche S.p.A. SB nevertheless has the right to resort to different or competing judicial authorities.

14. SUPPLY CHAIN SECURITY

Florim Ceramiche S.p.A. SB, in order to grant the security of the international supply chain, kindly asks its CUSTOMERS to comply with the security requirements laid down by AEO - Authorised Economic Operator - CUSTOMS - to safeguard the goods in the European Community during the activities of the forward and reverse flows. Florim Ceramiche S.p.A. SB CUSTOMERS undertake to meet the security and safety conditions during the operations of receiving, delivery, distribution, transport and storage, ensuring that the goods are taken into delivery, stocked, transported, prepared and loaded in safe places and in safe loading and shipping areas, well protected against intrusion and manipulation, with the only employ of reliable, authorized and duly trained own personnel

All items on this price list are exclusively sold in complete boxes.

THIS PRICE LIST CANCELS AND REPLACES ANY PREVIOUS ONES

CONDITIONS GÉNÉRALES DE VENTE

1 NORME CONTRACTUELLE

Sauf modifications ou dérogations convenues par écrit, les présentes conditions générales s'appliquent à tous les contrats de vente entre Florim et l'Acquéreur sans qu'il soit nécessaire d'y faire une référence expresse. Les variations des conditions générales de vente, les offres, crédits ou réductions accordés par nos agents ou d'autres intermédiaires ne sont valables que s'ils ont été acceptés par écrit par notre siège.

2 OBJET DE LA FOURNITURE

La fourniture correspond uniquement aux matériaux, prestations et quantités spécifiés dans notre confirmation de commande. Le texte de la confirmation de commande de Florim prévaut dans tous les cas par rapport au texte non conforme de la commande ou de l'offre éventuelle.

3 CONFIRMATION DE COMMANDE

En cas de divergences des éléments de la confirmation de commande de Florim par rapport aux accords ou aux commandes, l'Acquéreur pourra formuler une réclamation écrite dans les 7 jours suivant la réception de notre confirmation. Passé ce délai, la commande sera considérée comme ayant été acceptée telle qu'elle a été rédigée. Le client s'engage à communiquer à Florim Ceramiche S.p.A. SB, l'éventuelle variation du lieu de destination de la marchandise, si différente de celle prévue dans la confirmation de la commande, au plus tard le jour prévu du retrait chez Florim Ceramiche S.p.A. SB, par l'envoi, par poste, ou e-mail, des données d'identification du destinataire des marchandises et du lieu où la livraison devra être effectuée. En cas de manquement de communication la destination indiquée à l'origine sera tacitement confirmée.

4 PRIX

Les prix indiqués sur les catalogues Florim Ceramiche S.p.A. SB ne sont pas contraignants; nous nous réservons par conséquent le droit de les modifier préalablement à l'acceptation de la commande. Les prix conenus pour chaque vente s'entendent hors taxes, payés au comptant pour une livraison franco usine, sauf accord contraire stipulé par écrit. Si des hausses du coût des matières premières, de la main-d'œuvre, des combustibles, des frais de production et de transport, etc. et en cas d'une importante variation des taux de change entre la devise de facturation et la devise inter apparaissent entre la date de commande (même après la confirmation de commande) et la date de livraison, Florim Ceramiche S.p.A. SB pourra augmenter le prix convenu en informant l'Acquéreur par écrit, y compris par courrier électronique. Cependant, si ledit prix dépasse de 20% celui convenu lors de la commande, l'Acquéreur pourra résilier le contrat en nous faisant part de sa volonté par lettre recommandée dans un délai préemptoire de 10 jours à compter de la réception de l'avis d'augmentation du prix. Dans le cas contraire, le nouveau prix sera considéré comme ayant été accepté.

5 LIVRAISONS

La vente, sauf accord différent indiqué par écrit, s'entend toujours franco usine Florim Ceramiche S.p.A. SB. La marchandise voyage aux risques et périls de l'Acquéreur. Toutes nos responsabilités prennent fin avec la remise au transporteur, auquel l'Acquéreur, après les contrôles de rigueur, devra s'adresser pour d'éventuelles réclamations. Les expéditions de fournitures à l'étranger par voie terrestre ou maritime sont effectuées selon les conditions choisies d'une fois sur l'autre, conformément aux Incoterms approuvés par la Chambre de commerce internationale.

6 DÉLAIS DE LIVRAISON

Les délais de livraison sont donnés à titre indicatif: les éventuels retards de livraison, les interruptions, les suspensions totales ou partielles de fourniture n'ouvriront pas droit à une indemnisation ou à des dommages-intérêts, sauf accord contraire stipulé par écrit.

7 ÉCHANTILLONS

Les informations reportées sur les documents d'illustration de Florim Ceramiche S.p.A. SB, de même que les caractéristiques des échantillons et modèles envoyés par Florim Ceramiche S.p.A. SB à l'Acquéreur, sont données à titre purement indicatif. Ces données n'ont aucune valeur contraignante, à moins que cela ait été indiqué expressément dans l'offre ou dans l'acceptation écrite de Florim Ceramiche S.p.A. SB.

8 PAIEMENTS

Les factures de Florim Ceramiche S.p.A. SB, peuvent être émises le jour de la fourniture, à cadence bimensuelle ou mensuelle doivent être payées conformément à l'échéance prévue. Toute obligation de paiement entre les parties contractantes doit être exécutée auprès du siège de Florim Ceramiche S.p.A. SB. Les paiements éventuels faits à des agents, représentants ou auxiliaires de commerce de Florim Ceramiche S.p.A. SB ne seront considérés comme effectifs qu'à compter de la réception par Florim Ceramiche S.p.A. SB des sommes dues. Sauf accord contraire stipulé par écrit, le paiement devra être effectué au moment de la livraison auprès de l'institut bancaire indiqué par Florim Ceramiche S.p.A. SB. Tout retard ou toute irrégularité de paiement donnera à Florim Ceramiche S.p.A. SB le droit de suspendre les fournitures ou de résilier les contrats en cours, y compris ceux qui ne sont pas en lien avec les paiements en question, et de demander le remboursement des dommages éventuellement subis. Florim Ceramiche S.p.A. SB peut quoi qu'il en soit prétendre – à compter de l'arrivée à échéance du paiement, et sans nécessité de mise en demeure – à des intérêts moratoires conformément à la loi n° 231 du 09/10/2002. En cas de manquement même partiel, les intérêts moratoires sur le montant restant dû courent à compter du jour de la livraison, même si le délai de paiement convenu est fixé à une date ultérieure. Les réclamations relatives à des marchandises autres que celles de premier choix (B, commercial, 2e et 3e choix, correspondant, stock, etc.) ne seront pas prises en considération. Il ne sera donné aucun titre de garantie sur ces matériaux, ni implicitement ni explicitement. Obligation est faite à l'Acquéreur de contrôler la qualité et la quantité de la marchandise rapidement après la livraison et, en cas de réclamation, d'en donner communication par écrit dans les 8 (huit) jours suivant la réception sous peine de déchéance de ses droits. Les matériaux considérés comme défectueux devront être laissés à la disposition de Florim Ceramiche S.p.A. SB pour les contrôles jugés opportuns; toute action ultérieure (restitution, réparation ou autre) devra avoir été préalablement autorisée par écrit par nos soins. Les réclamations et demandes d'intervention en garantie postérieures à la pose ne seront pas prises en considération si le défaut constaté est manifeste (ex. pièces bréchées, défauts dimensionnels, différences de teinte, etc.). Il est précisé que le premier choix peut présenter des carreaux défectueux dans une limite de 5% et que la teinte du matériau fourni peut différer de l'échantillon exposé, l'aspect de la céramique étant intrinsèquement variable. Les réclamations pour des défauts ou des vices cachés devront être adressées par écrit dans les 8 (huit) jours suivant leur découverte, et dans tous les cas dans l'année suivant la livraison, sous peine d'une déchéance de tout droit à la garantie et au remboursement. La réclamation devra mentionner, outre les références de facturation, une description précise du vice et un devis des coûts de réparation ou de modification du produit; en l'absence de ces informations, la réclamation sera considérée comme nulle et non avenue. Si la réclamation se révèle infondée, l'Acquéreur devra rembourser à Florim Ceramiche S.p.A. SB tous les dépenses engagés dans le cadre des contrôles (déplacements, expertises, etc.) effectués. Les obligations de Florim Ceramiche S.p.A. SB se limitent qu'il en soit au remplacement des pièces défectueuses ou à leur réparation, à l'exclusion expresse de toute indemnisation ultérieure comme, à titre indicatif mais sans limitation aucune, pour des coûts de déplacement et de remise en place de mobilier, de matériel, de machines, etc., de manques à gagner du fait d'une interruption ou d'une suspension d'activité, de perturbations, de dommages indirects, etc. La présence de carreaux défectueux n'invalide pas la qualité de l'ensemble de la fourniture et n'entraîne aucune obligation de remplacement intégral. Les limites temporelles de la durée de garantie sont celles définies par le code civil italien.

9 GARANTIES ET RÉCLAMATIONS

La qualité des matériaux céramiques est définie sur la base des normes internationales en vigueur qui s'appliquent à la classe de produit correspondant. La garantie de Florim Ceramiche S.p.A. SB ne porte que sur la marchandise de premier choix fournie. Les réclamations relatives à des marchandises autres que celles de premier choix (B, commercial, 2e et 3e choix, correspondant, stock, etc.) ne seront pas prises en considération. Il ne sera donné aucun titre de garantie sur ces matériaux, ni implicitement ni explicitement. Obligation est faite à l'Acquéreur de contrôler la qualité et la quantité de la marchandise rapidement après la livraison et, en cas de réclamation, d'en donner communication par écrit dans les 8 (huit) jours suivant la réception sous peine de déchéance de ses droits. Les matériaux considérés comme défectueux devront être laissés à la disposition de Florim Ceramiche S.p.A. SB pour les contrôles jugés opportuns; toute action ultérieure (restitution, réparation ou autre) devra avoir été préalablement autorisée par écrit par nos soins. Les réclamations et demandes d'intervention en garantie postérieures à la pose ne seront pas prises en considération si le défaut constaté est manifeste (ex. pièces bréchées, défauts dimensionnels, différences de teinte, etc.). Il est précisé que le premier choix peut présenter des carreaux défectueux dans une limite de 5% et que la teinte du matériau fourni peut différer de l'échantillon exposé, l'aspect de la céramique étant intrinsèquement variable. Les réclamations pour des défauts ou des vices cachés devront être adressées par écrit dans les 8 (huit) jours suivant leur découverte, et dans tous les cas dans l'année suivant la livraison, sous peine d'une déchéance de tout droit à la garantie et au remboursement. La réclamation devra mentionner, outre les références de facturation, une description précise du vice et un devis des coûts de réparation ou de modification du produit; en l'absence de ces informations, la réclamation sera considérée comme nulle et non avenue. Si la réclamation se révèle infondée, l'Acquéreur devra rembourser à Florim Ceramiche S.p.A. SB tous les dépenses engagés dans le cadre des contrôles (déplacements, expertises, etc.) effectués. Les obligations de Florim Ceramiche S.p.A. SB se limitent qu'il en soit au remplacement des pièces défectueuses ou à leur réparation, à l'exclusion expresse de toute indemnisation ultérieure comme, à titre indicatif mais sans limitation aucune, pour des coûts de déplacement et de remise en place de mobilier, de matériel, de machines, etc., de manques à gagner du fait d'une interruption ou d'une suspension d'activité, de perturbations, de dommages indirects, etc. La présence de carreaux défectueux n'invalide pas la qualité de l'ensemble de la fourniture et n'entraîne aucune obligation de remplacement intégral. Les limites temporelles de la durée de garantie sont celles définies par le code civil italien.

10 RÉSERVE DE PROPRIÉTÉ

La vente de la marchandise s'effectue avec la clause de réserve de propriété. Par conséquent, si le paiement, du fait d'accords contractuels, est effectué en tout ou partie après la livraison, les produits livrés resteront la propriété de Florim Ceramiche S.p.A. SB jusqu'au paiement intégral du prix.

11 CESSIION DU CONTRAT

L'Acquéreur ne peut pas céder ses droits et obligations ni chacune des relations obligatoires nés du présent contrat sans l'accord écrit de Florim Ceramiche S.p.A. SB; même dans ce cas, l'Acquéreur restera solidaire du cessionnaire vis-à-vis des obligations cédées.

12 PROPRIÉTÉ INDUSTRIELLE ET DISTRIBUTION SÉLECTIVE - LIMITES À LA REVENTE

Florim Ceramiche S.p.A. SB est le titulaire et propriétaire légitime des exclusivités relatives aux marques, dessins et brevets d'invention. Pour garantir au mieux le respect des droits exclusifs de Florim Ceramiche S.p.A. SB et les empêcher d'être consommés de manière abusive, Florim Ceramiche S.p.A. SB gère la fourniture des produits par l'intermédiaire d'un système de distribution sélective. Les fournitures acquises auprès de Florim Ceramiche S.p.A. SB et de ses points de vente sélectifs agréés sont destinées à une installation auprès de l'utilisateur final; aucune autre forme de revente à des intermédiaires commerciaux autres que les utilisateurs finals n'est autorisée, sauf autorisation préalable de Florim Ceramiche S.p.A. SB stipulée par écrit. Toute revente de marchandise en violation de ce principe doit donc être considérée comme interdite et assimilée à un usage illicite des droits de propriété industrielle et intellectuelle de Florim Ceramiche S.p.A. SB, donnant droit à Florim Ceramiche S.p.A. SB de demander la saisie de ladite marchandise auprès de son détenteur. Florim Ceramiche S.p.A. SB se réserve le droit de poursuivre en justice quiconque serait impliqué dans des reventes non autorisées.

13 LOI APPLICABLE ET JURIDICTION COMPÉTENTE

Le contrat est régi par la loi italienne, y compris les Usages de branche de la Province de Modène. Le tribunal de Modène est exclusivement compétent pour tout litige relatif au contrat de fourniture entre Florim Ceramiche S.p.A. SB et l'Acquéreur. Florim Ceramiche S.p.A. SB garde néanmoins la faculté de saisir des juridictions concurrentes ou alternatifs.

14 SÛRETÉ DANS LA CHAÎNE LOGISTIQUE

FLORIM CERAMICHE S.P.A. SB, afin d'assurer la sûreté de la logistique internationale, demande à ses CLIENTS le respect des standards des rapports contractuels pour assurer la sûreté des biens et leur conformité aux normes de la OEA (Opérateur Economique Agréé – Douanes) dans tous les pays de l'Union Européenne. Les CLIENTS de Florim Ceramiche S.p.A. SB s'engagent à veiller à ce que la marchandise prise en charge ou livrée soit expédiée ou transportée, stockée, préparée et chargée dans des dépôts sûres et sur des endroits de chargement et d'expédition sûres, bien protégée contre possibles manipulations pas autorisées, et n'utilisant que du personnel autorisée et possiblement bien qualifié.

L'ensemble des articles de ce catalogue sont vendus exclusivement par paquets entiers.

LE PRÉSENT CATALOGUE ANNULE ET REMPLACE LES PRÉCÉDENTS

ALLGEMEINE GESCHÄFTSBEDINGUNGEN

1 VERTRAGSVORSCHRIFTEN

Ces Conditions Générales de Vente s'appliquent à tous les contrats de vente entre Florim Ceramiche S.p.A. SB et le client, à moins que cela ait été indiqué expressément dans l'offre ou dans l'acceptation écrite de Florim Ceramiche S.p.A. SB. Les modifications ou dérogations convenues par écrit, les présentes conditions générales s'appliquent à tous les contrats de vente entre Florim Ceramiche S.p.A. SB et le client, à moins que cela ait été indiqué expressément dans l'offre ou dans l'acceptation écrite de Florim Ceramiche S.p.A. SB. Les variations des conditions générales de vente, les offres, crédits ou réductions accordés par nos agents ou d'autres intermédiaires ne sont valables que s'ils ont été acceptés par écrit par notre siège.

2 GEGENSTAND DER LIEFERUNG

La fourniture correspond uniquement aux matériaux, prestations et quantités spécifiés dans notre confirmation de commande. Le texte de la confirmation de commande de Florim Ceramiche S.p.A. SB prévaut dans tous les cas par rapport au texte non conforme de la commande ou de l'offre éventuelle.

3 AUFTRAGSBESTÄTIGUNG

En cas de divergences des éléments de la confirmation de commande de Florim par rapport aux accords ou aux commandes, l'Acquéreur pourra formuler une réclamation écrite dans les 7 jours suivant la réception de notre confirmation. Passé ce délai, la commande sera considérée comme ayant été acceptée telle qu'elle a été rédigée. Le client s'engage à communiquer à Florim Ceramiche S.p.A. SB, l'éventuelle variation du lieu de destination de la marchandise, si différente de celle prévue dans la confirmation de la commande, au plus tard le jour prévu du retrait chez Florim Ceramiche S.p.A. SB, par l'envoi, par poste, ou e-mail, des données d'identification du destinataire des marchandises et du lieu où la livraison devra être effectuée. En cas de manquement de communication la destination indiquée à l'origine sera tacitement confirmée.

4 PREISE

Die auf den Florim Ceramiche S.p.A. SB -Preislisten angeführten Preise sind unverbindlich; Demzufolge behalten wir uns das Recht vor, sie vor der Auftragsannahme abzuändern. Sofern keine anderen schriftlichen Vereinbarungen vorliegen, verstehen sich die für jeden Einzelverkauf vereinbarten Preise netto, gegen bar, Lieferung ab Werk. Sollten zwischen dem Bestelldatum (auch nach der Auftragsbestätigung) und dem Lieferdatum ein Kostenanstieg der Rohstoffe, Löhne, Brennstoffe, Herstellung, des Transports usw. auftreten, oder im Falle einer wesentlichen Änderung der Wechselkurse zwischen der Rechnungswährung und der lokalen Währung, kann Florim Ceramiche S.p.A. SB den vereinbarten Preis erhöhen, indem er dies dem Käufer schriftlich, auch mittels E-Mail, mitteilt. Sollte besagter Preis jedoch den bei der Bestellung vereinbarten Preis um 20% übersteigen, hat der Käufer die Möglichkeit, vom Vertrag zurückzutreten, indem er uns binnen der bindenden Frist von 10 Tagen nach Erhalt der Mitteilung bez. des Preisanstiegs seinen Willen per Einschreiben meldet. In Ermangelung dessen gilt der neue Preis als angenommen.

5 LIEFERUNGEN

Der Verkauf, sofern nicht schriftlich anders vereinbart, ist immer ab Florim Ceramiche S.p.A. SB-Werk. Der Warentransport erfolgt auf Risiko und Gefahr des Käufers. Unsere Haftung endet mit der Übergabe an den Frachtführer, an den der Käufer nach angemessener Überprüfung eventuelle Beanstandungen zu richten hat. Auslandslieferungen auf dem See- oder Landweg werden auf der Grundlage von Fall zu Fall gewählten Bedingungen vorgenommen, die in den von der Internationalen Handelskammer gebilligten "Incoterms" aufgeführt sind.

6 LIEFERBEDINGUNGEN

Die Lieferbedingungen sind hinweisend: Eventuelle Lieferverzögerungen, Unterbrechungen, komplette oder partielle Einstellungen der Lieferungen berechtigen weder zu einer Entschädigung noch zu einem Schadensersatz, sofern keine anderen schriftlichen Vereinbarungen vorliegen.

7 MUSTER

Die auf den veranschaulichenden Dokumenten von Florim Ceramiche S.p.A. SB abgebildeten Angaben sowie die Eigenschaften der vom Letztgenannten dem Käufer zugesandten Muster und Modelle sind als ungefähre Angaben zu verstehen und behält sich nicht ausdrücklich vorbehalten. Unsere Haftung endet mit der Übergabe an den Käufer in der schriftlichen Annahme von Florim Ceramiche S.p.A. SB erwahrt wurden.

8 ZAHLUNGEN

Die Rechnungen von Florim Ceramiche S.p.A. SB können am Tag der Lieferung ausgestellt werden, 14-tägig oder monatlich und sind netto innerhalb der vereinbarten Frist zu bezahlen. Jegliche Zahlungsverpflichtung zwischen den Vertragspartnern ist am Florim Ceramiche S.p.A. SB -Sitz zu erfüllen. Eventuell an Handelsagenten, Vertreter oder Geschäftshelfer von Florim Ceramiche S.p.A. SB geleistete Zahlungen verstehen sich so lange als nicht vorgenommen, bis die bezüglichen Summen bei Florim Ceramiche S.p.A. SB eingehen. Die Bezahlung hat, vorbehaltlich anderer schriftlicher Vereinbarungen, unmittelbar nach der Lieferung beim Bankinstitut zu erfolgen, das von Florim Ceramiche S.p.A. SB angegeben wurde. Jegliche Zahlungsverzögerungen und -unregelmäßigkeiten geben Florim Ceramiche S.p.A. SB das Recht, die Lieferungen einzustellen oder die laufenden Verträge aufzulösen, auch wenn sie sich nicht auf die zutreffenden Zahlungen beziehen, sowie das Recht auf den Ersatz etwaiger Schäden. Florim Ceramiche S.p.A. SB hat auf jeden Fall Anspruch auf die Verzugszinsen – ab der Verzugsfrist und ohne die Notwendigkeit einer Inverzugsetzung – in der laut Gesetzesverordnung Nr. 231 vom 09.10.2002 vorgesehenen Höhe. Im Falle einer auch nur teilweisen Nichterfüllung laufen die Verzugszinsen für den nicht bezahlten Betrag ab dem Tag der Lieferung, auch wenn als Zahlungsfrist ein späteres Datum vereinbart wurde. Keine Beanstandung oder Streitigkeit bezüglich der Warenqualität, Mängel oder Defekte, oder jedes anderen Vertragsaspekts ist wirksam und kann in Betracht gezogen werden, und gleichermaßen kann keine Klage eingeleitet werden, sofern keine vollständige Bezahlung des Preises erfolgte (Klausel solve et repete). Die Verrechnung mit eventuell entstandenen Forderungen gegen Florim Ceramiche S.p.A. SB ist unzulässig.

9 GARANTIE UND BEANSTANDUNGEN

Die Qualität des Keramikmaterials wird auf der Grundlage der geltenden internationalen Rechtsvorschriften festgelegt, die auf die jeweilige Produktklasse Anwendung finden. Florim Ceramiche S.p.A. SB garantiert nur die als erste Wahl gelieferte Ware. Beanstandung über die nicht zur ersten Klasse gehörenden Waren (B-Wahl, kommerzielle, zweite, dritte, zweitrangige Wahl, Lagerbestand, usw.) bleiben unberücksichtigt, wobei auf diese Materialien keine Art von Garantie, weder implizit noch explizit, erteilt wird. Der Käufer ist verpflichtet, die Ware binnen kurzer Zeit ab Erhalt der Lieferung und Qualität zu prüfen und bei einer Beanstandung dieselbe schriftlich binnen spätestens 8 (acht) Tagen ab Warenerhalt mitzuteilen, da andernfalls jeglicher Anspruch verwirkt. Die als fehlerhaft betrachtete Ware ist Florim Ceramiche S.p.A. SB für seine als angemessen betrachteten Überprüfungen verfügbar zu halten; jeder weitere Vorgang (Rückersatzung, Reparatur oder sonstiges) bedarf unserer vorherigen schriftlichen Genehmigung. Beanstandungen und Beantragungen von Garantieeingriffen nach erfolgter Verlegung werden nicht in Betracht gezogen, sofern sich der beanstandete Defekt als offensichtlich erweisen sollte (zum Beispiel Schlagstellen, Maßunterschiede, Tonabweichungen, usw.). Es wird präzisiert, dass die erste Wahl bis zu 5% fehlerhafte Fliesen enthalten und die Färbung und die Farbgebung des gelieferten Materials vom ausgestellten Muster abweichen darf, da Keramik von Natur aus unterschiedlich aussehen kann. Auf verborgene Fehler oder Mängel bezogene Beanstandungen sind schriftlich binnen 8 (acht) Tagen ab ihrer Feststellung und auf jeden Fall binnen einem Jahr ab Lieferung zu formalisieren, da andernfalls die Verwirkung jeglichen Anspruchs auf Garantie und Entschädigung droht. Die Mitteilung muss neben den Rechnungsdaten eine genaue Beschreibung des Mangels und einen Kostenvoranschlag der Reparatur oder Änderung des Produkts enthalten; in Ermangelung dieser Angaben wird die Beanstandung als nichtig betrachtet. Sollte sich die Beanstandung als unbegründet erweisen, muss der Käufer Florim Ceramiche S.p.A. SB alle für die Überprüfung aufgetragenen Kosten (Reisen, Sachverständigen, Gutachten, usw.) vergüten. Die Pflicht von Florim Ceramiche S.p.A. SB beschränkt sich auf jeden Fall allein auf den Ersatz nur der fehlerhaften Teile oder auf die Reparatur, mit ausdrücklichem Ausschluss anderweitiger Entschädigungen wie beispielsweise - aber nicht ausschließlich - für Kosten zur Beseitigung und Wiederherrichtung von Möbeln, Ausrüstungen, Maschinen, usw., entgangene Gewinne wegen Tätigkeitsunterbrechung oder -einstellung, Unannehmlichkeiten, Folgeschäden, usw. Das Vorhandensein fehlerhafter Fliesen setzt weder die Güte der Gesamtlieferung herab noch ist damit die Pflicht des Gesamtsatzers verbunden. Die zeitlichen Beschränkungen der Garantiedauer sind laut dem italienischen Bürgerlichen Gesetzbuch festgelegt.

10 EIGENTUMSVORBEHALT

Der Warenverkauf erfolgt mit der Klausel des Eigentumsvorbehalts; deshalb bleiben die gelieferten Produkte, sofern deren Bezahlung laut Vertragsvereinbarungen gänzlich oder teilweise nach der Lieferung zu erfolgen hat, bis zur vollkommenen Bezahlung des Preises Eigentum von Florim Ceramiche S.p.A. SB.

11 VERTRAGSBREITUNG

Der Käufer darf seine Stellung im Vertrag oder in einzelnen, aus diesem herrührenden obligatorischen Verhältnissen ohne schriftliche Einwilligung von Florim Ceramiche S.p.A. SB nicht abtreten; Auch in diesem Fall haftet der Käufer weiterhin mit dem Unternehmer solidarisch für die abgetretenen Verpflichtungen.

12 GERWERBLICHES EIGENTUM UND SELEKTIVER VERTRIEB BESCHRÄNKUNGEN BEIM WEITERVERKAUF

Florim Ceramiche S.p.A. SB ist Inhaber und rechtmäßiger Besitzer von Alleinrechten bezüglich Marken, Zeichnungen und Erfinderpapenten. Um die Beachtung der Alleinrechte von Florim Ceramiche S.p.A. SB und die Ansprüche der Endkunden im Hinblick auf die erwarteten Güteeigenschaften auf ein Höchstmaß gewährleisten zu können, liefert Florim Ceramiche S.p.A. SB seine Produkte im Rahmen eines selektiven Vertriebsystems. Die von Florim Ceramiche S.p.A. SB und seinen dazu befugten selektiven Verkaufsstellen gelieferten Produkte sind für die Verlegung beim Endbenutzer bestimmt. Eine andere Form des Weiterverkaufs an weitere Handelsvertreter, die nicht den Endbenutzern entsprechen, ist ohne vorherige schriftliche Einwilligung von Florim Ceramiche S.p.A. SB unzulässig. Die Ware, dessen Weiterverkauf trotz dieses Verbots erfolgte, ist somit als unzulässig zu betrachten und einem unerlaubten Gebrauch der gewerblichen und geistigen Eigentumsrechte von Florim Ceramiche S.p.A. SB gleichzusetzen, wobei Florim Ceramiche S.p.A. SB berechtigt ist, die Beschlagnahme bei jedem Besitzer zu beantragen. Florim Ceramiche S.p.A. SB behält sich das Recht vor, gegen all diejenigen gerichtlich vorzugehen, die an einem unbefugten Weiterverkauf beteiligt sind.

13 VERTRAGSGESETZ - ZUSTÄNDIGES GERICHT

Der Vertrag ist durch das italienische Gesetz, einschließlich der Branchengewohnheiten der Provinz Modena, geregelt. Für jegliche aus dem Liefervertrag herrührende Streitigkeit sowohl seitens Florim Ceramiche S.p.A. SB als auch des Käufers ist allein das Gericht Modena zuständig. Es ist jedoch in der Fakultät von Florim Ceramiche S.p.A. SB, konkurrierende oder alternative Foren anzurufen.

14 SICHERHEIT DES LOGISTISCHEN ABLAUFES

Um die Sicherheit des internationalen Logistikablaufs zu gewährleisten, verlangt Florim Ceramiche S.p.A. SB von seinen KUNDEN, dass sie sich an die Standardanforderungen halten, um die Sicherheit von Waren in vertraglichen Beziehungen zu gewährleisten und um die Einhaltung mit dem AEO - Authorized Economic Operator - Zollwesen, in der gesamten Europäischen Gemeinschaft sicherzustellen. Die Florim Ceramiche S.p.A. SB-KUNDEN verpflichten sich, zu gewährleisten, dass die übernommenen oder gelieferten Waren in sicherem Gelände und in sicheren Lade- und Versandbereichen versandt, transportiert, gelagert oder verladen, und vor unbefugter Manipulation geschützt werden, wobei nur autorisiertes und entsprechend ausgebildetes Personal eingesetzt werden darf.

Alle Artikel dieser Preisliste werden nur in ganzen Kartons verkauft.

DIE VORLIEGENDE PREISLISTE ANNULLIERT UND ERSETZT DIE VORHERIGEN PREISLISTEN.

CONDICIONES GENERALES DE VENTA

1 NORMATIVA CONTRACTUAL

Salvo modificaciones o derogaciones acordadas por escrito, las presentes condiciones generales disciplinan todos los contratos de venta entre Florim Ceramiche S.p.A. SB y el Comprador sin necesidad de una referencia expresa a ellos. Las variaciones de las condiciones generales de venta, ofertas, bonificaciones o descuentos, acordados por nuestros agentes o por otros intermediarios, solo son válidas previa aceptación escrita de nuestra empresa.

2 OBJETO DEL SUMINISTRO

El suministro comprende solamente los materiales, prestaciones y cantidades especificados en nuestra confirmación de pedido. El texto de la confirmación de pedido de Florim Ceramiche S.p.A. SB prevalecerá siempre sobre el texto de cualquier oferta o pedido.

3 CONFIRMACIÓN DE PEDIDO

Si la confirmación de pedido de Florim Ceramiche S.p.A. SB difiere de los acuerdos o pedidos en cuanto a los elementos que la componen, el Comprador podrá enviar la correspondiente reclamación por escrito en el plazo de 7 días a partir de la recepción de nuestra confirmación; en caso contrario, esta se considerará aceptada tal como ha sido redactada. Si el lugar de entrega de la mercancía es diferente del indicado en la confirmación de pedido, el cliente se compromete a comunicarlo a Florim Ceramiche S.p.A. SB antes del día previsto para el retiro en la sede de esta última. Dicha comunicación se debe realizar por correo, telefax o correo electrónico, y debe incluir los datos identificativos del destinatario de los bienes y del lugar en el que se debe realizar la entrega. En defecto de esta comunicación, el destino indicado originalmente se considera tácitamente confirmado.

4 PRECIOS

Los precios indicados en las listas Florim Ceramiche S.p.A. SB no son vinculantes: en consecuencia, nos reservamos el derecho a modificarlos antes de la aceptación del pedido. Los precios acordados para cada venta son netos, con pago en efectivo y entrega franco fábrica, salvo acuerdo escrito en contrario. Si entre la fecha del pedido (incluso después de la confirmación de la entrega) y la fecha de entrega se verificarán aumentos en los costes de las materias primas, mano de obra, combustibles, gastos de producción, transporte, etc. y en caso de variaciones importantes en los tipos de cambio entre la divisa de facturación y la divisa interna, Florim Ceramiche S.p.A. SB podrá aumentar el precio acordado, comunicándolo por escrito al Comprador (también por telefax o correo electrónico). Si dicho precio supera en un 20 % el acordado en el momento del pedido, el Comprador podrá rescindir el contrato, comunicando su decisión por correo certificado en el plazo perentorio de 10 días a partir de la recepción de la notificación de aumento de precio. En su defecto, el nuevo precio se considerará aceptado.

5 ENTREGAS

La venta, salvo acuerdo escrito en sentido contrario, siempre es franco fábrica Florim Ceramiche S.p.A. SB. La mercancía viaja a cargo y riesgo del Comprador. Toda responsabilidad nuestra cesa en el momento de la entrega al transportista, ante el cual, una vez realizados los controles necesarios, el Comprador deberá plantear sus eventuales reclamaciones. Los envíos al exterior, por vía marítima o terrestre, se realizan según las condiciones establecidas en cada caso, indicadas en los "Incoterms" aprobados por la Cámara de Comercio Internacional.

6 PLAZOS DE ENTREGA

Los plazos de entrega tienen carácter indicativo; eventuales retrasos de las entregas, interrupciones y suspensiones totales o parciales de los suministros no darán derecho a indemnizaciones o resarcimientos de daños, salvo acuerdo escrito en contrario.

7 MUESTRAS

Los datos indicados en los documentos ilustrativos de Florim Ceramiche S.p.A. SB, así como las características de las muestras y modelos enviados por este último al Comprador, tienen carácter indicativo. Estos datos no tienen valor vinculante, excepto en la medida en que hayan sido expresamente mencionados como tales en la oferta o en la aceptación escrita de Florim Ceramiche S.p.A. SB.

8 PAGOS

Las facturas de Florim Ceramiche S.p.A. SB pueden ser emitidas el día de suministro, con cadencia quincenal o mensual y su importe neto debe ser pagado en el plazo acordado. Todas las obligaciones de pago entre las partes contrayentes se deben cumplir en la sede de Florim Ceramiche S.p.A. SB. Eventuales pagos efectuados a agentes, representantes o auxiliares de comercio de Florim Ceramiche S.p.A. SB no se considerarán realizados hasta el momento en que las sumas correspondientes sean acreditadas a Florim Ceramiche S.p.A. SB. Salvo acuerdo escrito en contrario, el pago se deberá realizar en el momento de la entrega, en el banco indicado por Florim Ceramiche S.p.A. SB. Cualquier retraso o irregularidad en el pago da a Florim Ceramiche S.p.A. SB derecho a suspender los suministros o a resolver los contratos en curso, incluso si no corresponden a los pagos incumplidos, así como al resarcimiento de los eventuales daños. En todo caso, a partir del vencimiento del pago y sin necesidad de declaración de mora, Florim Ceramiche S.p.A. SB tiene derecho a percibir los intereses de mora en la medida prevista por el decreto legislativo N.º 231 del 09/10/2002. En caso de incumplimiento, incluso parcial, los intereses de mora sobre el importe no pagado se calcularán a partir del día de la entrega, incluso si el plazo de pago había sido acordado en una fecha posterior. Ninguna reclamación o controversia inherente a la calidad de la mercancía, imperfecciones, defectos o cualquier otro aspecto del contrato será eficaz ni podrá ser tomada en consideración, y ninguna acción podrá ser iniciada, hasta el pago integral del precio (cláusula solve et repete). No se admiten compensaciones con eventuales créditos de cualquier naturaleza ante Florim Ceramiche S.p.A. SB.

9 GARANTÍAS Y RECLAMACIONES

La calidad del material cerámico se define sobre la base de las normas internacionales aplicables a la clase de producto correspondiente. Florim Ceramiche S.p.A. SB garantiza solo la mercancía de primera calidad. Reclamaciones relativas a mercancía de otras calidades (calidad B, comercial, segunda, tercera, secundaria, existencias, etc.) no serán tomadas en consideración, ni se dará ningún tipo de garantía —implícita o explícita— sobre dicho material. El Comprador tiene la obligación de verificar la calidad y cantidad de la mercancía en breve plazo después de su recepción y, en caso de reclamarlo, comunicarlo por escrito en el plazo de 8 (ocho) días a partir de la recepción, bajo pena de caducidad de cualquier derecho. El material considerado defectuoso deberá ser puesto a disposición de Florim Ceramiche S.p.A. SB para los controles que considere necesarios; cualquier otra acción (restitución, reparación, etc.) deberá ser autorizada previamente por Florim Ceramiche S.p.A. SB en forma escrita. Las reclamaciones y solicitudes de intervención en garantía después de la colocación no serán consideradas en el caso de que el defecto reclamado resulte manifiesto (por ejemplo: desportilladuras, defectos dimensionales, diferencias de tono, etc.). Se señala que la primera calidad puede contener hasta un 5 % de baldosas defectuosas y que el tono del material suministrado puede diferir de la muestra expuesta, dado que la cerámica es intrínsecamente variable en su aspecto. Las reclamaciones por defectos o imperfecciones ocultos deberán ser formalizadas por escrito en el plazo de 8 (ocho) días a partir de su descubrimiento; en todo caso, en el plazo de un año a partir de la entrega, bajo pena de caducidad de cualquier derecho a garantía y resarcimiento. Además de los datos de facturación, la comunicación deberá contener una precisa descripción del defecto y un presupuesto de los costes de reparación o modificación del producto; en ausencia de estos datos, la reclamación se considerará nula. Si la reclamación resulta infundada, el Comprador deberá resarcir a Florim Ceramiche S.p.A. SB todos los gastos realizados para la verificación (viajes, peritajes, etc.). En todo caso, la obligación de Florim Ceramiche S.p.A. SB se limita a la sustitución de las piezas defectuosas o a la reparación, quedando expresamente excluidas otras indemnizaciones, como - a título indicativo, no limitativo - costes de desplazamiento y relocalización de mobiliario, equipo, maquinaria, etc., lucro cesante debido a la interrupción o suspensión de actividades, molestias, daños indirectos, etc. La presencia de baldosas defectuosas no afecta la calidad del suministro en su conjunto, ni comporta la obligación de su sustitución integral. La duración de la garantía es la establecida por el código civil italiano.

10 RESERVA DE DOMINIO

La venta de la mercancía se realiza con cláusula de reserva de dominio; por lo tanto, si los acuerdos contractuales prevén que el pago debe ser realizado -total o parcialmente- después de la entrega, los productos entregados seguirán siendo propiedad de Florim Ceramiche S.p.A. SB hasta el pago integral del precio.

11 CESIÓN DEL CONTRATO

El Comprador no puede ceder su posición en el contrato ni en relaciones obligatorias eventualmente derivadas del mismo, sin la aceptación escrita de Florim Ceramiche S.p.A. SB. En tal caso, el Comprador seguirá siendo responsable solidariamente con el cesionario de las obligaciones cedidas.

12 PROPIEDAD INDUSTRIAL Y DISTRIBUCIÓN SELECTIVA - LÍMITES DE REVENTA

Florim Ceramiche S.p.A. SB es titular y legítimo poseedor de la exclusividad de las marcas, dibujos y patentes de invención. Con el objetivo de garantizar adecuadamente el respeto de los derechos exclusivos de Florim Ceramiche S.p.A. SB, así como las expectativas de los consumidores finales en cuanto a las características cualitativas previstas, Florim Ceramiche S.p.A. SB controla la distribución de sus productos mediante un sistema de distribución selectiva. Los suministros enviados por Florim Ceramiche S.p.A. SB y por los puntos de venta autorizados están destinados a la instalación por parte del usuario final o está permitida ninguna forma de reventa a otros intermediarios comerciales diferentes de los usuarios finales, salvo previa autorización escrita de Florim Ceramiche S.p.A. SB. Por lo tanto, la reventa de mercancía que viole esta prohibición se debe considerar no permitida y equiparada a un uso ilícito de los derechos de propiedad industrial e intelectual de Florim Ceramiche S.p.A. SB, con derecho de esta última a solicitar la incautación de la mercancía a cualquier poseedor. Florim Ceramiche S.p.A. SB se reserva el derecho a proceder judicialmente contra todo aquel que esté involucrado en reventas no autorizadas.

13 LEY DEL CONTRATO - TRIBUNAL COMPETENTE

El contrato está disciplinado por la ley italiana, incluidos los Usos del Sector de la Provincia de Módena. Para cualquier controversia derivada del contrato de suministro, tanto por parte de Florim Ceramiche S.p.A. SB como por parte del Comprador, tiene competencia exclusiva el Tribunal de Módena. No obstante, es facultad de Florim Ceramiche S.p.A. SB recurrir a foro competidores o diferentes.

14 SEGURIDAD DE LA CADENA LOGÍSTICA

Florim Ceramiche S.p.A. SB, con la finalidad de garantizar la seguridad de la cadena logística internacional, les ruega a sus propios CLIENTES el respeto de unos requisitos estándar para garantizar la seguridad de las mercancías objeto de relaciones contractuales y para garantizar su conformidad con la normativa AEO - Operador Económico Autorizado - Aduanas, en toda la Comunidad Europea. Los CLIENTES de Florim Ceramiche S.p.A. SB se comprometen a garantizar que las mercancías recogidas en consigna o consignadas sean expedidas o transportadas, almacenadas, preparadas o cargadas en locales seguros y en zonas de carga y expedición seguras, protegidas contra manumisiones no autorizadas, utilizando solo personal interno autorizado y oportunamente instruido.

Todos los artículos del presente listín se venden exclusivamente en cajas completas.

EL PRESENTE LISTÍN ANULA Y SUSTITUYE LOS LISTINES ANTERIORES.

Quanto contenuto nel catalogo è indicativo e non esaustivo riguardo alle grafiche, decori e ai colori riportati.

Contents of this catalog is indicative and not exhaustive with regard to graphics, decors and colors shown.

Le contenu du catalogue est indicative et non exhaustive en ce qui concerne graphiques, décors et couleurs indiquées.

Die Beschreibungen im Katalog sind indikativ und nicht allumfassend in Bezug auf Grafiken, Dekore und Farben.

El contenido de este catálogo es indicativo y no exhaustivo con respecto a gráficas, decoros y colores ilustrados.



Florim Ceramiche S.p.A. SB

Via Canaletto, 24 /41042 Fiorano Modenese (MO) / T. +39 0536 840111 / F. +39 0536 844750 / florim.com